

saia

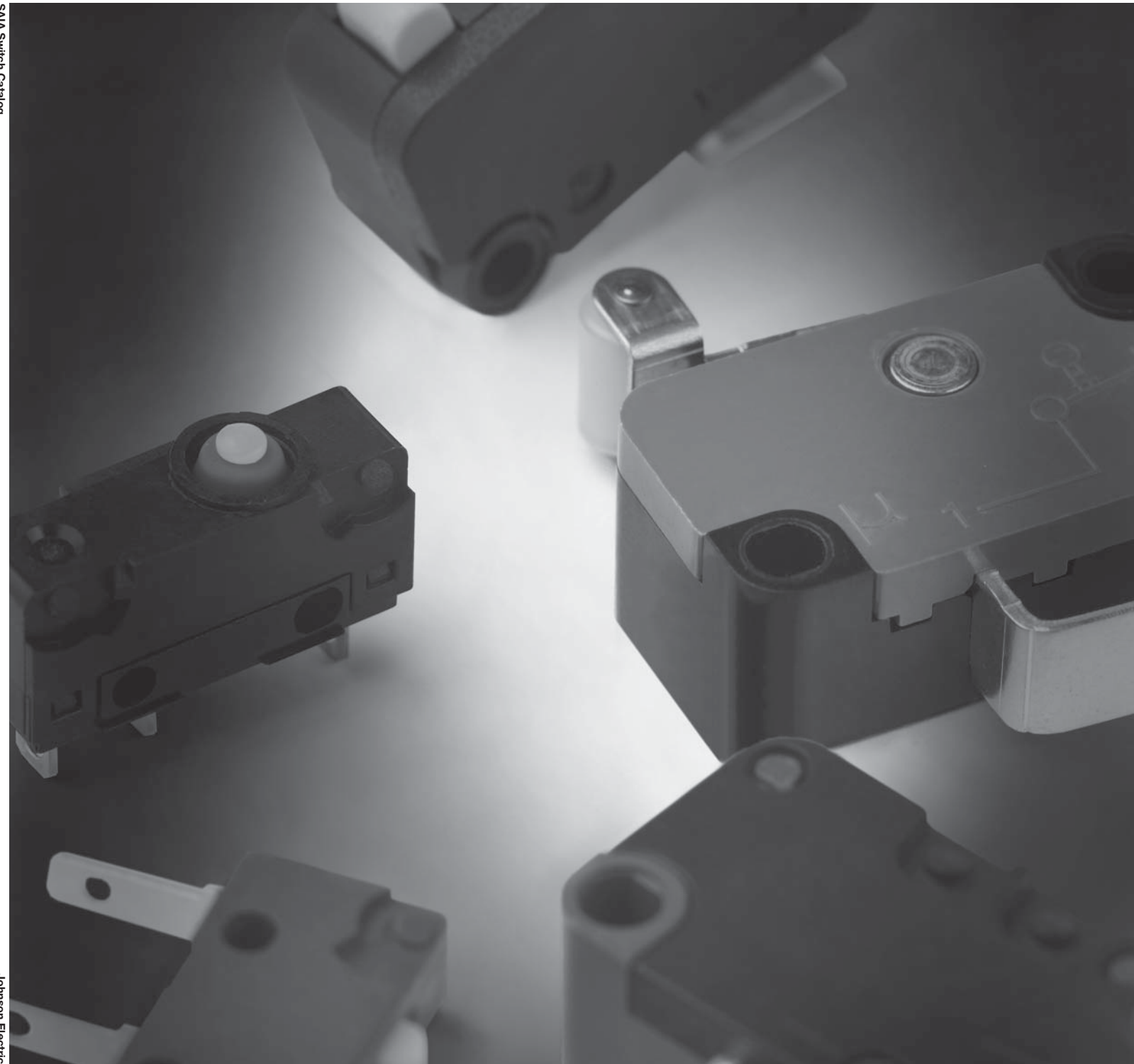

SAIA Switch Catalog

Johnson Electric

 **JOHNSON
ELECTRIC**

... innovating motion ...

The data used in this Product Overview may be used as a guideline only. Specific operational characteristics of our products may vary according to individual applications. It is strongly recommended that specific operating conditions are clarified with Johnson Electric before application.

Johnson Electric Terms and Conditions of Sale apply.

All data may be subject to change without notice.

Table of Contents

Johnson Electric Group

Overview	2
How we are organized	3
Looking for a specialized switching solution?	4
Saia is a leading global brand for switches for the appliances and consumer products industries	5
Switches for Locking Mechanisms	5
Switches in the Circuit Breaker Industry	6
Switches for domestic appliances	6
Terminology: Snap-action switches	7
Snap-action Microswitches	14
Thermoset plastic	
Subminiature	XC

	15

Thermoplastic Microswitches

Subminiature	X4	20
	

Sealed Microswitches

Subminiature	V4NS	25
	
	V4NCS	29
	

Thermoset plastic Microswitches

Miniature	XG	34
	

Thermoplastic Microswitches

Miniature	X3	39
	

3 mm contact gap Microswitch

Miniature	340	44
	

Table of preferred products	47
-----------------------------	----

Overview

The Johnson Electric Group is one of the world's largest providers of motion subsystems and motion components for automotive, medical and industrial applications.

Over the years, we have shipped billions of motors to more than thirty countries in over one hundred different applications. Johnson Electric has an annual production capacity of one billion motors and motion subsystems.

At the heart of Johnson Electric's success is our commitment to make our customers successful. Our customers include many of the world's leading industrial, consumer and automotive companies. We begin by understanding our customers' business needs, and the product application requirements of the end user of our customers' products. Then we design and deliver innovative motion solutions that help our customers to differentiate their products in the marketplace. Our goal is to be instrumental in the successful launch of our customers' products in their respective marketplaces.

Our Brand Promise **Johnson Electric delivers competitive advantage**

Johnson Electric delivers differentiation and innovation through its motion products – subsystems comprising of Stepper Motors, DC Motors, AC Motors, Piezo-electric Motors, Switches, Solenoids, Flexi Circuits, Motion Control, Precision Plastics and Precision Gears.

Johnson Electric is the most reliable partner

Johnson Electric is responsive and flexible; and has the financial stability and organizational integrity to meet all of our commitments and to support our customers' success. Product reliability and assurance of supply are our commitment.

Johnson Electric is «The Safe Choice»

- Financial strength and long standing supplier relationships.
- Unmatched assurance of supply.
- Rigorous supply chain management and complete integrity in compliance with standards.
- Unsurpassed on-time delivery.
- Global logistics support 24/7.
- Collaborative design and project management process.
- Product life cycle support from creation to end-of-life.

Our business growth hinges with leading «branded» goods producers to deliver differentiation and innovation through our motion products. The core platform for delivering these solutions is a highly developed production base and focused customer support teams throughout the world. This combines scale advantages in production and procurement with skilled and dedicated motion application experts.

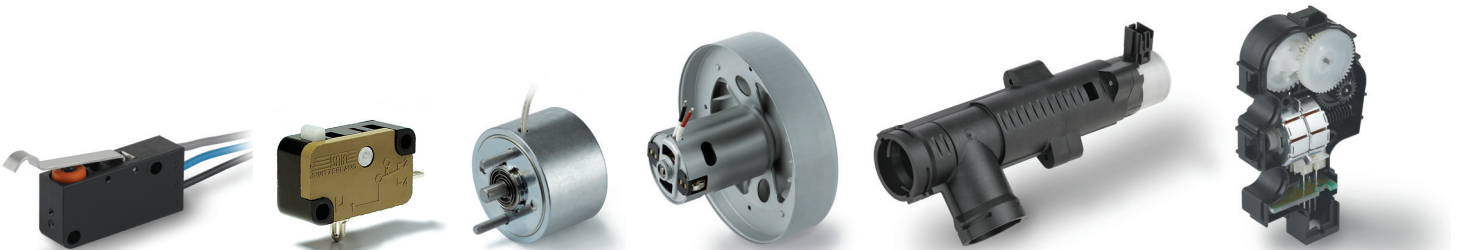

How we are organized

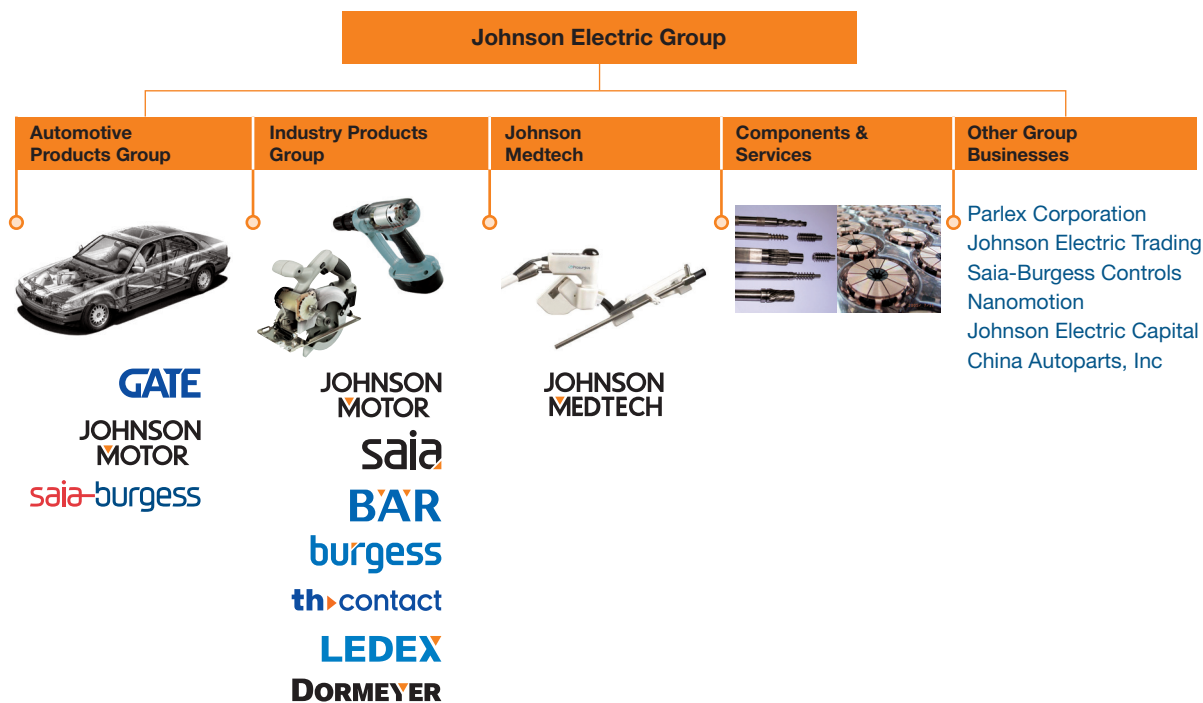

The Group's motion systems, motors and switches businesses are managed through three operating divisions: Automotive Products Group, Industry Products Group and Johnson Medtech.

The Automotive Products Group (APG) is focused on providing customized motion solutions for all major automotive applications. APG goes to market under three product brands: Saia-Burgess for custom actuators; GATE for engine cooling fan modules; and Johnson Motor for DC motors and brushless DC motors.

The Industry Products Group (IPG) provides motion products and solutions for various commercial and industrial application sectors, including home appliances, power tools, business equipment, personal care products, medical equipment, building automation, security, audio-visual and other industrial products. IPG goes to market under seven product brands: Johnson Motor for DC motors, AC motors and BLDC motors; Saia Motor for stepper motors and synchronous motors; Ledex and Dormeyer for solenoids; and Saia, Bär, Burgess, th-contact brands for switches.

Johnson Medtech is an ISO13485 certified designer and manufacturer of motion related products for the medical device industry. The focus of Johnson Medtech is

primarily in subsystem for medication delivery systems, surgical robotics and image guided surgery.

Supporting these three business units is the Components & Services division which produces metal and plastic parts, tooling and production equipment for the Group. Johnson Electric is a highly vertically integrated business that manufactures an exceptionally wide range of components that form the basis for its final products. We make magnets, bearings, shafts, housings, laminations, commutators and die cast parts. We also build tools, assembly fixtures, plastic molds as well as armature winding and other production machines.

Supporting our customers worldwide are sixteen R&D centres located in Hong Kong (China), Shenzhen (China), Shanghai (China), Nagano (Japan), Yokneam (Israel), Asti (Italy), Murten (Switzerland), Halver (Germany), Dresden (Germany), Oldenburg (Germany), Isle of Wright (Parlex), San Jose (USA), Methuen (USA), Vandalia (USA), Springfield (USA) and Plymouth (USA).

The Group also includes a number of complementary subsidiary companies. These include an innovative provider of flexible printed circuits and interconnect solutions; a successful niche player in the programmable controls industry; and a rapidly growing China auto parts business.

Looking for a specialized switching solution?

Look no further:

In addition to the wide range of standard products shown in Johnson Electric catalogues, we will be happy to work with you to meet your system needs. If your application requires more than a standard product solution, please consider us early in your design process. Our product development team will be happy to discuss your specification, whether you need a special value-added assembly or a complete system. We specialize in developing solutions for medium and high-volume applications.

The images shown give some examples of our capabilities.

Building Automation & Security



Home Appliances, White Goods, Floor Care

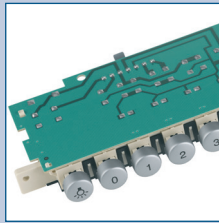

Business Machines, Leisure & Fitness

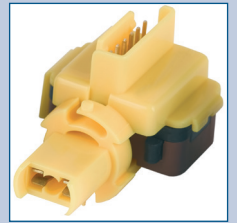

Subsystems

Transportation

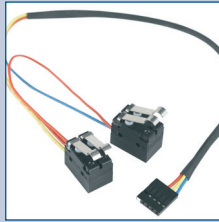

Industrial Equipment & Automation



Value Added Solutions

Power & Garden Tools



Healthcare & Medical Equipment



Products



Saia is a leading global brand for switches for the appliances and consumer products industries

Saia defines precision switching for high volumes.

The Saia brand focuses firmly on miniature and subminiature snap-action switch types, the world's two most commonly used industry standards.

Wide range

Snap-action switches have to fulfill a wide variety of functions. Whether it is signal or power switching, high or low force actuation, there will be a Saia switch for your application – with extensive terminal and lever options to make your selection straightforward.

Environmental protection

The sealed switch is a Saia specialty. In demanding environments - wet, humid or dusty – even the most sensitive signal can be switched reliably with IP67 rated products.

Uncompromising reliability

With many UL, CSA and ENEC approvals, the performance of Saia products is globally recognized. With tens of millions of switches produced each year, this reliability is proven and established.

Precision actuation

Snap-action switches offer high levels of repeat accuracy and switch virtually independently of actuation speed and force. This is the mechanism of choice for pressure sensing, timing and position indicating applications.

Typical Saia switch applications

- Washing/drying machines
- Coffee machines
- Gaming machines
- Electric showers
- Power tools and garden equipment

Switches for Locking Mechanisms

Switches are found in numerous applications that require a locking device. Whether it is a medical application, an office automation application or a door lock, switches provide an effective, cost-efficient locking mechanism.

Security Applications

- Hotel room door lock
- Hotel safe lock
- Prison door lock
- Fire safety door opening lock

Medical

- Sterilizer lock
- Centrifuge lock
- Blood analysis machine lock

Office Automation

- Disk drive door lock
- Personal computer chassis lock
- Docking station lock
- Locks to hold peripherals in place
- Tape library index lock

Consumer

- Oven door lock for selfcleaning function
- Home safe lock



Switches in the Circuit Breaker Industry

Switches can be found in a variety of circuit breaker applications, for both domestic and commercial installations:

Domestic Circuit Breakers

- Most commonly used switches to trip breaker

Industrial Breakers

- Higher rated switches are typically used for industrial applications due to the higher switching loads

Heavy Duty Industrial Breakers

- Used in commercial and industrial applications for switching heavy loads

Molded Case Breakers

- Similar to domestic single and double pole breakers

Reclosers

- Oil or vacuum filled high voltage breakers

Switches for domestic appliances

Switches are found in numerous applications in the appliance industry.

Saia switches for domestic appliances

Switches used in domestic appliances have:

- a wide range of actuating force options
- reliability throughout the life of the product
- compliance with relevant UL, CSA and ENEC approvals
- the ability to switch power or signal
- environmental protection in wet or dusty applications

Saia switches for power tools and garden equipment

Switches used in power tools and garden equipment must:

- work reliably and safely, time after time
- have appropriate environmental protection to resist dust and moisture

Saia switches for vending and gaming machines

Gaming machines demand:

- dependability and reliability
- a high degree of shock resistance in the mechanism
- good tactile feel

Other application examples:

- Dispensing valves
- Beverage dispensing valves
- Product dispensers on vending machines
- Coin changers on vending machines
- Actuating devices on commercial baking and food processing or packaging equipment

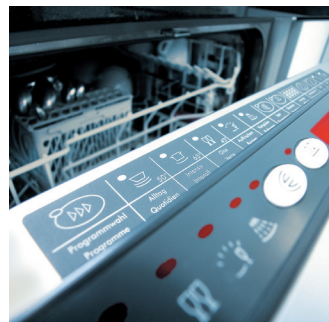

Terminology: Snap-action switches

Positions – forces – movements

Free position	Position of the actuator, without any influence from an external force.
Operating position	Position of the actuator when contact changeover takes place.
Total travel position	Position of the actuator at the end of the allowed travel.
Release position	Position of the actuator when the switch mechanism resets.
Actuating force	The force required to move the actuator from the free position to the operating position.
Release force	The value to which the applied force must be reduced to allow the mechanism to reset after operation.
Force differential	Difference between actuating force and release force.
Pre-travel	Movement of the switch actuator between free and operating position.
Over-travel	Movement of the switch actuator beyond the operating position.
Total travel	The sum of pre-travel and over-travel.
Movement differential	Distance between operating position and release position.
Release travel	Movement of the switch actuator between release and total travel position.
Post release travel	Movement of the switch actuator between release and free position.

Contact force – movement – diagram

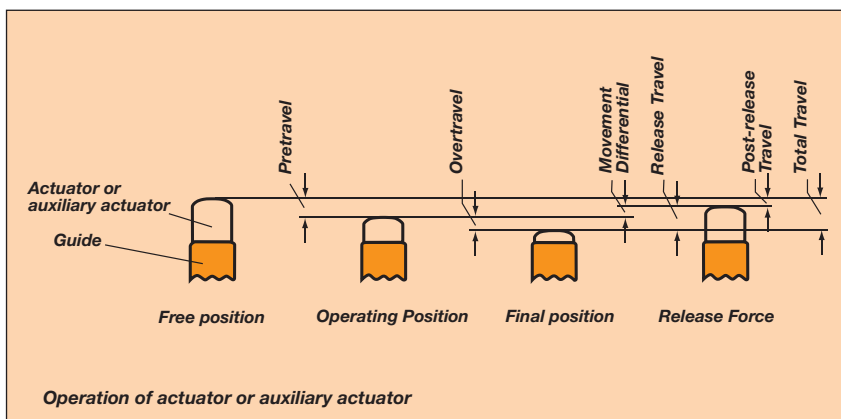

Actuating force – movement – diagram

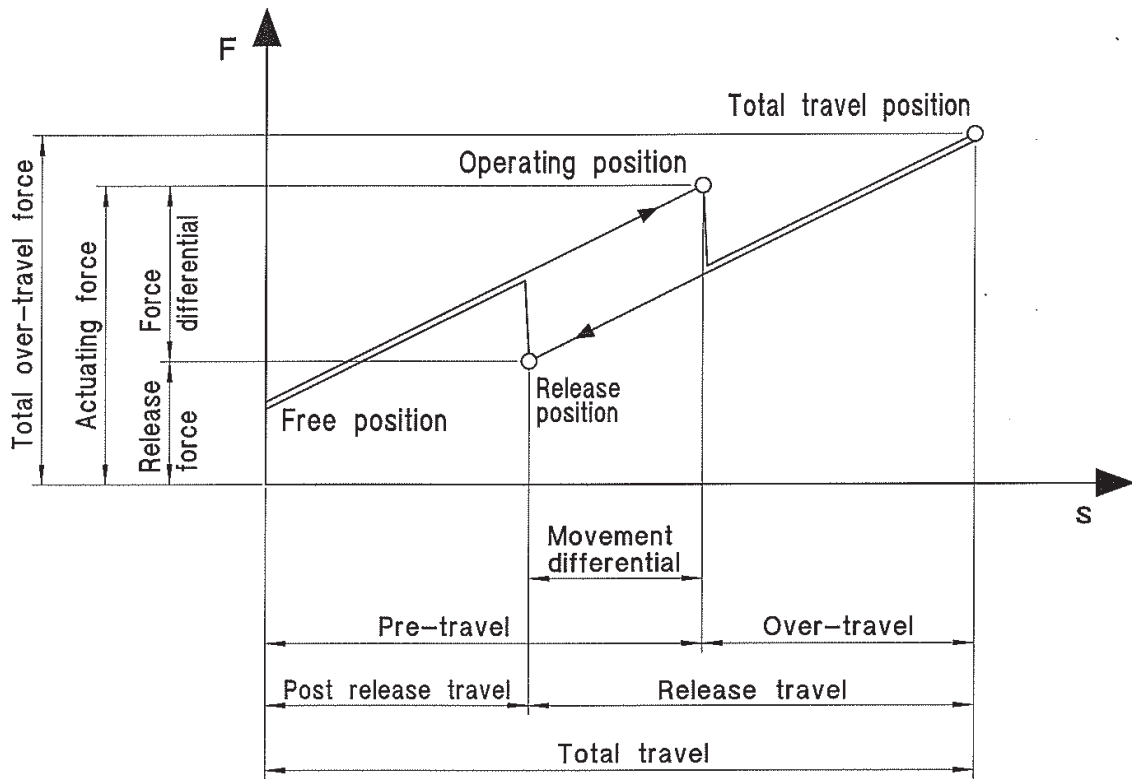

Contact force – movement – diagram

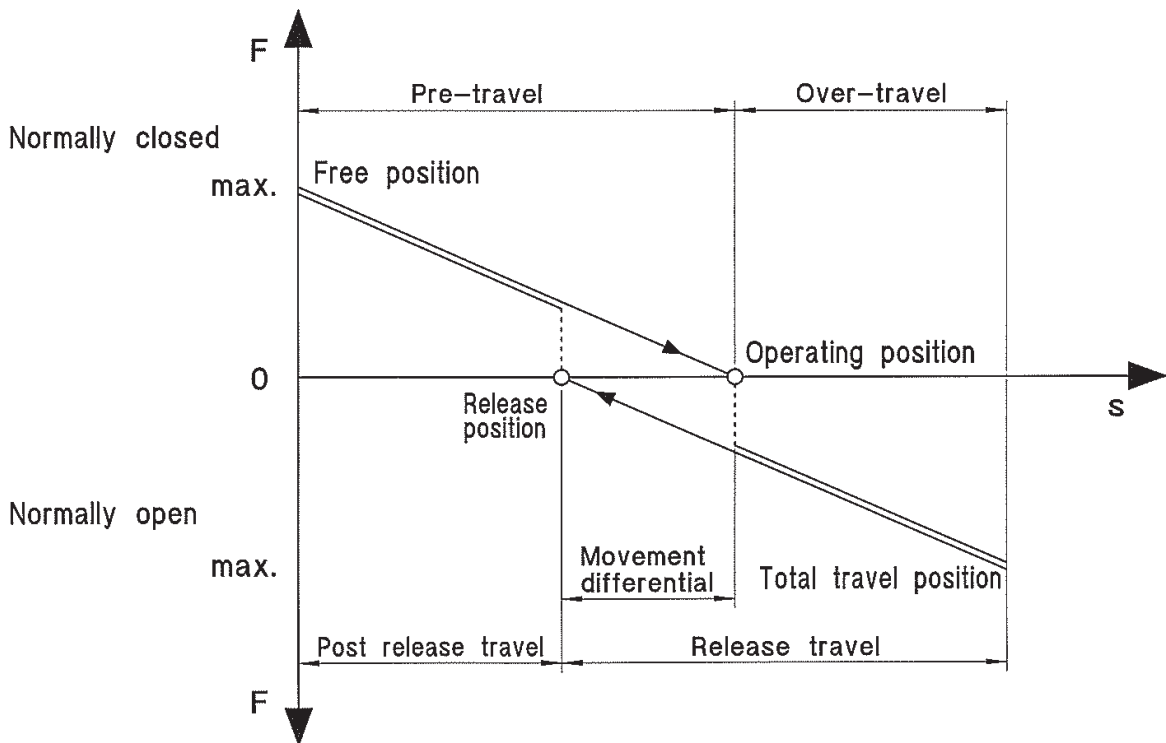

Switch Technology

Clearance Distance – the distance in air between current carrying parts of opposite polarity or between any current carrying part and an earthed-(grounded) metal plate to which the switch is attached.

Creepage Distance – the path along the surface of insulating material between current carrying parts of opposite polarity or between any current carrying part and an earthed (grounded) metal plate to which the switch is attached.

Insulation Resistance – resistance as measured between the normally closed terminals, or between all terminals connected together and a metal plate to which the switch is mounted. In dry conditions the value would be expected to be greater than 5MΩ.

Single Throw – a switch which provided an ON-OFF or OFF-ON function but does not change over from one conductor to another. Such switches are usually referred to as being «normally-closed only» or «normally-open only».

Switching Cycle – one complete switching operating from free position into overtravel and back through release position to free position.

Switch Resistance – a total resistance offered by a switch in a circuit, as measured from terminal through mating contacts, to terminal.

Transit Time – the time taken by the moving contact in a snap-action mechanism to move from one stable position to another.

Electrical Ratings

Electrical ratings given in the catalog are ratings according to UL1054, CSA22,55 or IEC61058-1.

Where these are not available, a general rating is given based upon in-house laboratory testing.

The ratings tables should be considered as safe working maximums for most applications. However, switch performance is influenced by a variety of factors, including:

- Frequency of operation
- Type of load
- Amount of travel used
- Temperature
- Humidity

Please do not hesitate to contact Saia about your specific application.

Approvals



CSA mark. Switch meets CSA's safety standards



UL Recognized Component Mark for Canada and the United States



ENEC Mark. Switch fulfills European EN standards. The two digit number indicates which certification body has issued the ENEC Certificate



CQC Approval (China) is available for certain switches

Switch Life

a. Electrical Life – the electrical life data contained in this catalog is based on laboratory controlled tests. In practice, frequency and speed of operation, type of load, suppression, actuator travel used, ambient humidity and temperature and other environmental conditions can have a major effect on switch life.

Individual assessments for specific applications are possible and can be undertaken by Saia on request. Please ask Saia if you would like an assessment for your specific application.

b. Mechanical Life – the figures quoted relate to the number of switching cycles made without an electrical load.

Switch Drawings

All drawings in this catalogue are third angle projection. All dimensions in this catalogue are nominal, except where specifically shown.

Application Technology

Shock and Vibration

If switches are likely to be subjected to shock or vibration, select models with the highest available actuating force. Saia-switches feature low mass mechanisms which are inherently resistant to shock and vibration. If possible, the switches should be mounted so that the line of acceleration is at right angles to the travel of the plunger. The maximum available overtravel should be used.

Direct Current

Direct current (DC) ratings where shown should not be exceeded if destructive arcing and contact welding are to be avoided. Some form of arc suppression is recommended when switches are used in DC circuits containing inductive devices wired in series with the switch and the supply.

Lamp Loads

Because of the very high inrush currents associated with incandescent lamps, applications should be subject to individual assessment.

Capacitive Loads (including fluorescent lamps)

These can generate very high peak currents which can cause contact welding. Applications should be subject to individual assessment.

Inductive Loads

The general ratings tables included in this catalog provide data for switches used to control inductive circuits at a power factor of 0,5 (EN 0,6; UL 0,7 means HP-Rating 0,5).

Contact Materials

Silver and silver alloys are the primary contact materials used in Saia-switches.

The ratings tables shown refer to switches with silver/silver alloy contacts.

Gold contacts should be specified when switches are to be used in low voltage control or logic circuits, especially when long periods of inactivity are expected or when atmospheres with a high sulphur content may be encountered. Gold contacts are generally available in two forms; gold plated silver alloy contacts, which can also be used at higher currents or gold alloy cross-point contacts, which are only suitable for switching low currents.

Please ask Saia if you would like an assessment for your specific application.

Contact Resistance

The contact resistance is the electrical resistance measured at the terminals of the switch when the contacts are closed.

Switch Actuation

Direct Operation

Actuating plungers should be operated in the direction of their axis. Where this is not possible the use of actuating levers is recommended. For direct actuation the attack angle should not exceed 30°.

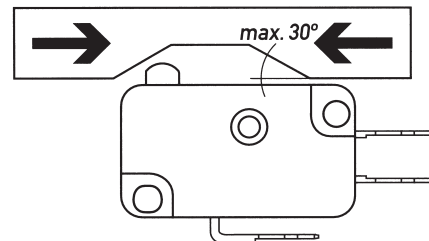

Actuation by sliding cams.

Actuating Levers

Various lever types are available for use with Saia-switches. They are generally stainless steel.

If roller or cam-follower levers are approached in the reverse direction, care must be taken to ensure that the angle of approach is small enough not to jam the lever.

Actuation by Cams

Cam-follower levers are particularly well suited for use with plastic actuating cams.

Abrupt actuation or release of switch actuators shortens the life of the switches.

For this reason cam should preferably provide a continuous movement. Ideally they should be of cycloidal form.

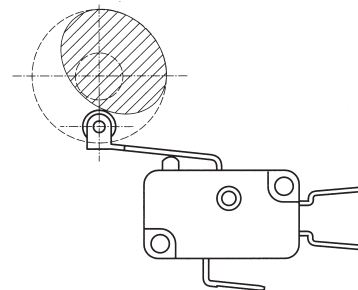

Long roller lever with continuous actuation

Environmental Protection

Protection Classifications

The protection classes of Saia switches are in accordance with IEC 529 and are covered by just four codes.

IP40

Adequate protection against solids such as probing fingers and small wires >1mm. Liquids however can gain access and, unless externally protected, the switches should be mounted in dry or well-sheltered positions.

IP54

Good protection against solid foreign bodies, including dust and water splashing against the enclosure from any direction.

Switches may be used out of doors if sheltered from the worst of the elements or on factory machines subjected to normal washing down procedures.

IP65

Complete protection against solids, including dust, and against low pressure jets of water from all directions.

IP67

Complete protection against solids including dust and against immersion in water at a specific pressure for a specified time.

We reserve this code for switches which are factory sealed and tested.

Switches should not be immersed in any liquid.

Working Temperatures

For details of the working temperatures applicable to individual types, refer to the appropriate specification sheet. Special versions suitable for temperatures outside these ranges may be possible. Please contact us for information.

All quoted temperatures assume stable operation. They do not imply an ability to withstand excessive cycling within the range.

Health & Safety

Saia has ensured, so far as it is reasonably practicable, that their products are as described in this catalog or in other current company publications, or as specified on Saia installation drawings. They have been so designed and constructed as to be safe and without risk to health when installed by suitably qualified personnel in accordance with relevant legislation, codes of practice, regulations (including IEE Wiring Regulations), the installation recommendations offered by the company and the accepted rules of the art. Their usage should be confined within the ratings limitations and parameters of-application indicated in this catalog and elsewhere.

Please contact us should you need additional information or guidance.

Service Recommendations

Maintenance

Saia switches are not user-maintainable but they should be kept in a reasonably clean, paint-free condition, especially in the actuator area. Regular checks should be made on mounting security and on the actuating medium to switch actuator relationship.

Lubrication or the use of aqueous or chemical cleaning fluids is not recommended.

Installation Recommendations

The following notes are intended merely to stress the most important and general aspects of good switch installation procedure and to provide some helpful additional information. **Safety Consideration**
Installation should only be carried out by competent personnel.

Switch Positioning and Operation

Pre-loading of the switch actuator must be avoided. The actuating medium must be able to operate the switch through the operating position into overtravel and then to retract far enough to allow the switch to regain its free position.

Saia recommends that the actuating medium should drive the switch into at least 50% of the available overtravel.

All ratings tables shown in this catalog are based on the use of all the available overtravel.

Mounting

Side mounting switches should be mounted on smooth, firm, flat surfaces using the recommended screw size.

Avoid over tightening the screws. For added security, they should be locked using epoxy resin. Do not attempt to enlarge switch mounting holes and avoid over stressing the switch. Use insulating material between the switch and metallic plates to increase clearance on switches with open terminals.

Connections

When soldering, overheating of the switch insulation must be avoided. In certain circumstances, it may be advisable to use a heat shunt. For optimum mechanical strength, the conductor should be wrapped round the tip of the terminal taking care to avoid loose strands of wire.

The soldering iron tip should be applied to the end of the terminal while simultaneously applying solder. Remove the iron as soon as the solder has wetted the conductor and terminal end. A soldering iron tip temperature of 350°C (260°C/5 seconds for PCB Terminals) applied for a maximum of 2-3 seconds should be adequate.

For lead-free solder, is usually needed an iron tip temperature 15% higher.**Health & Safety**

Installation Recommendations (EN 61058-1)

Mounting Holes and Screw sizes			Mounting Screw Torque		
Normal hole Diameter (mm)(in)	Screw	Metric Thread Screw	Unified mild steel screws:	For guidance when using	
2,2/2,3	0,067/0,091	M2	#2	M2 or #2 screws	0,15Nm
3,1/3,2	0,122/0,126	M3	#4	M3 or #4 screws	0,5Nm
3,6/3,7	0,142/0,146	M3,5	#6	M3,5 or #6 screws	0,8Nm
5,1/5,2	0,201/0,205	M5	#10	M5 or #10 screws	3,0Nm

Snap-action Microswitches

Subminiature

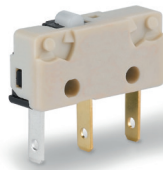
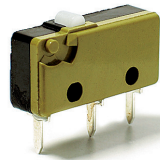

Type	XC	X4	V4NS	V4NCS
Characteristics	<ul style="list-style-type: none"> wide range of forces and variants long mechanical and electrical life solder, PCB and faston terminals compliant to glow wire test IEC 60335-1, 4. ed. 	<ul style="list-style-type: none"> thermoplastic housing long mechanical and electrical life solder, PCB and faston terminals compliant to glow wire test IEC 60335-1, 4. ed. 	<ul style="list-style-type: none"> sealed (IP67) solder 2,8 mm faston and PCB terminals pre-wired option compliant to glow wire test IEC 60335-1, 4. ed. 	<ul style="list-style-type: none"> wide variety of levers peg mounting option pre-wired option sealed (IP6K7) solder and faston terminals PCB terminals
Rating	250 VAC, 10 A max.	250 VAC, 12 A max.	250 VAC, 5 A max.	250 VAC, 5 A max.
Dimensions (mm)	19,9 × 9,5 × 6,4	19,9 × 9,7 × 6,4	20 × 10,3 × 6,4	20 × 10,3 × 6,4
Actuator	<ul style="list-style-type: none"> plunger mushroom plunger plain levers simulated roller lever/cam follower roller levers 	<ul style="list-style-type: none"> plunger plain levers cam follower lever roller levers 	<ul style="list-style-type: none"> plunger plain levers roller levers simulated roller lever/cam follower 	<ul style="list-style-type: none"> plunger plain levers roller levers simulated roller lever/cam follower
Approvals	ENEC, UL, cUL, CSA	UL, cUL, CSA, ENEC, CQC	UL, CSA, ENEC	Automotive standard
Page	17	22	27	31

Miniature

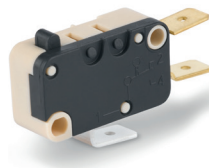
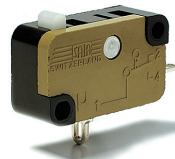

Type	XG	X3	340
Characteristics	<ul style="list-style-type: none"> wide range of forces and ratings long mechanical and electrical life solder, faston and PCB terminals compliant to glow wire requirements IEC 60335-1, 4. ed. 	<ul style="list-style-type: none"> 8 mm creepage and clearance distance to the actuator long mechanical and electrical life solder, faston and PCB terminals compliant to glow wire requirements IEC 60335-1, 4. ed. 	<ul style="list-style-type: none"> wipping contacts, leaf spring mechanism 3 mm contact gap, compliant to glow wire requirements IEC 60335-1, 4. ed. as optional item
Rating	250 VAC, 26 A max.	250 VAC, 21 A max.	250 VAC, 16 A max.
Dimensions (mm)	27,8 × 15,9 × 10,3	27,8 × 15,9 × 10,3	28,8 × 20,4 × 10,1
Actuator	<ul style="list-style-type: none"> plunger plain levers roller levers simulated roller levers 	<ul style="list-style-type: none"> plunger straight lever simulated roller levers roller levers 	<ul style="list-style-type: none"> plunger roller lever plain levers simulated roller lever moulded lever
Approvals	ENEC, UL, cUL, CSA	UL, cUL, CSA, ENEC, CQC	ENEC, UL
Page	36	41	46

Snap-action Microswitches

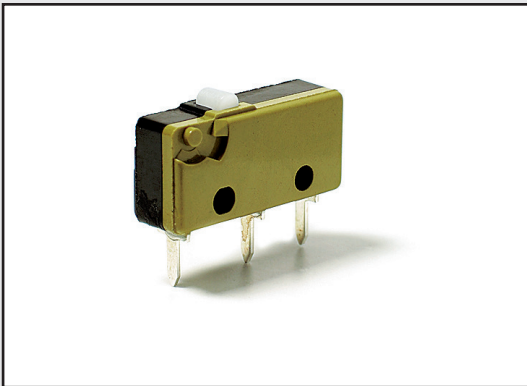

Circuit diagram

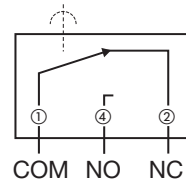

Dimension

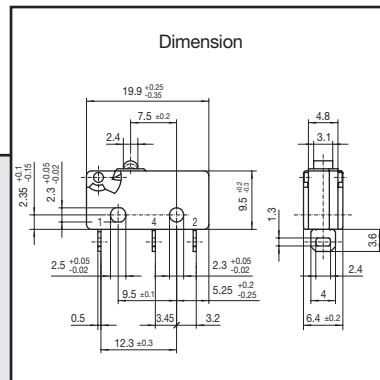

XC

- Characteristics
- wide range of forces and variants
 - long mechanical and electrical life
 - solder, PCB and faston terminals
 - compliant to glow wire test IEC 60335-1, 4. ed.

Rating 250 VAC, 10 A max.

Dimensions (mm) 19,9 × 9,5 × 6,4

- Actuator
- Plunger
 - mushroom plunger
 - plain levers
 - simulated roller lever/cam follower
 - roller levers

Approvals ENEC, UL, cUL, CSA

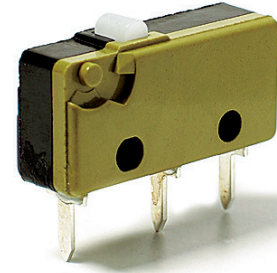

Preferred Range

Ordering Reference	Actuating Force		Operating pos.		Terminal	Circuit	Actuator	Contacts	Electrical rating	
	(N)	(ozf)	(mm)	(in)					ENEC	UL/CSA
XCG3Z1	1,7	6,07	8,4	0,33	Solder	CO	Plunger	Ag	6(2) A	5 A
XCG3-J1Z1	0,6	2,14	10,2	0,40	Solder	CO	Plain lever	Ag	6(2) A	5 A
XCG3-S1Z1	0,7	2,49	15,6	0,61	Solder	CO	Roller lever	Ag	6(2) A	5 A
XCG5Z1	1,7	6,07	8,4	0,33	Faston 2,8 × 0,5 mm	CO	Plunger	Ag	6(2) A	5 A
XCG5-J1Z1	0,6	2,14	10,2	0,40	Faston 2,8 × 0,5 mm	CO	Plain lever	Ag	6(2) A	5 A
XCG5-S1Z1	0,7	2,49	15,6	0,61	Faston 2,8 × 0,5 mm	CO	Roller lever	Ag	6(2) A	5 A
XCG8-81Z1	1,7	6,07	8,4	0,33	PCB	CO	Plunger	Au	none	0,1 A/125 VAC
XCG8-81-J1Z1	0,6	2,14	10,2	0,40	PCB	CO	Plain lever	Au	none	0,1 A/125 VAC
XCG8-81-S1Z1	0,7	2,49	15,6	0,61	PCB	CO	Roller lever	Au	none	0,1 A/125 VAC
XCF3Z1	3,0	10,70	8,4	0,33	Solder	CO	Plunger	Ag	10(3) A	10,1 A
XCF3-J1Z1	1,05	3,74	10,2	0,40	Solder	CO	Plain lever	Ag	10(3) A	10,1 A
XCF3-S1Z1	1,1	3,92	15,6	0,61	Solder	CO	Roller lever	Ag	10(3) A	10,1 A
XCG3-U1Z1	1,7	6,07	9,9	0,39	Solder	CO	Mushroom plunger	Ag	6(2) A	5 A
XCG4-U1Z1	1,7	6,07	9,9	0,39	Faston 2,8 × 0,5 mm	CO	Mushroom plunger	Ag	6(2) A	5 A
XCG8-U1Z1	1,7	6,07	9,9	0,39	PCB	CO	Mushroom plunger	Ag	6(2) A	5 A

Specifications

Housing	Melamine-Formaldehyd, Thermosetting
Plunger	POM for T85, PPS for T125 and T150
Mechanism	Snap-action system with stainless steel tension spring
Functions	Change-over, NO, NC
Contacts	Fine silver (Ag) or 10 µm Gold (Au), microprofile
Terminals	Solder, faston and various PCB terminals (side of housing or side of lid, as well as 1/10" o lin pitch)
Temperature range °C	Between -40°C and +85°C (special version up to 140°C)
Mechanical life	up to 5×10^7 cycles (Actuation: sinusoidal and up to 80% of overtravel)
Protection	Enclosure IP40
Mounting	Side mounting through mounting holes
Actuators	Stainless steel, PA66-GF35
Contact Carrier	CuZn or CuSn

Circuit diagram

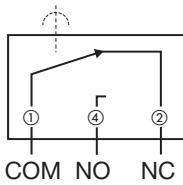

Actuating force/travel

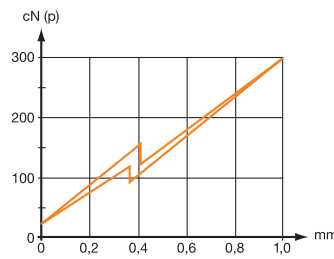

Contact force/travel

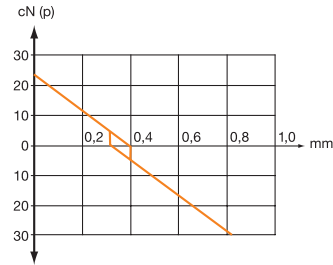

Dimensions

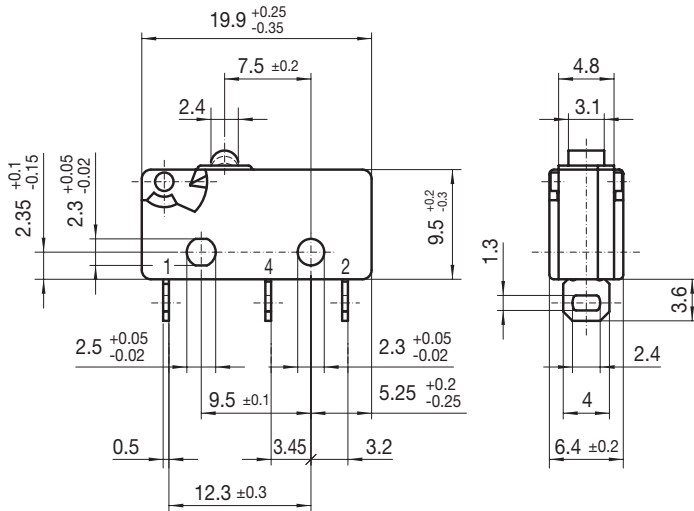

FP = Free Position
OP = Operating Position

Maximum DC rating

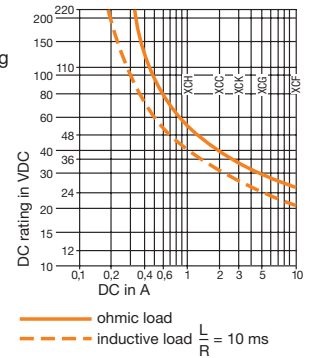

Recommended maximum electrical ratings

Voltage	Resistive load		Motor load (A)	Approvals ENEC		Approvals UL		Motor load	
	(VAC)	(A)		(A)	(VAC)	(A)	(VAC)		
XCF	250	10	3	10 (3)	1E4	250	10,1	125/250	¼ HP
XCG	250	6	2	6 (2)	5E4	250	5	250	—
XCK	250	5	3	5 (3)	1E4	250	5	250	—
XCC	250	3	1	3 (1)	5E4	250	2	250	—
XCH	250	1,5	0,3	1,5 (0,3)	5E4	250	1	250	—

Breaking capacities in the tables refer to Ag contacts.

Operating Characteristics

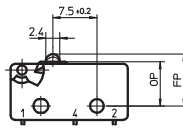
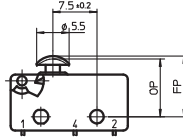
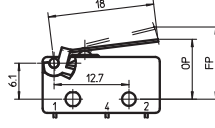
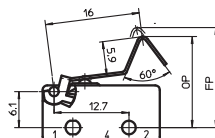
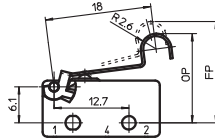
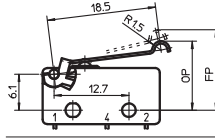
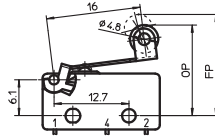
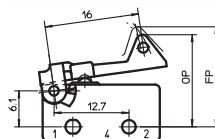
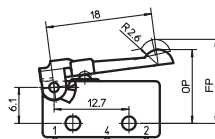
Actuator	Reference	Actuating Force		Release Force		Free Position		Operating Position		Movement Differential		Total travelled position		
		Maximum (N)	(ozf)	Minimum (N)	(ozf)	Maximum (mm)	(in)	(mm)	(in)	Maximum (mm)	(in)	Maximum (mm)	(in)	
	XCF..	3	10,70	0,5	1,78	8,8	0,34	8,4	$\left. \begin{matrix} 0,33 \\ 0,33 \\ 0,33 \\ 0,33 \end{matrix} \right\} \begin{matrix} +0,1 \\ -0,3 \end{matrix}$	$\left. \begin{matrix} 0,33 \\ 0,33 \\ 0,33 \\ 0,33 \end{matrix} \right\} \begin{matrix} +0,003 \\ -0,011 \end{matrix}$	0,1	0,003	7,7	0,303
	XCG..	1,7	6,07	0,3	1,07	8,8	0,34	8,4			0,1	0,003	7,7	0,303
	XCK..	1,2	4,28	0,2	0,71	8,8	0,34	8,4			0,1	0,003	7,7	0,303
	XCC..	0,6	2,14	0,1	0,36	8,8	0,34	8,4			0,1	0,003	7,7	0,303
	XCH..	0,35	1,24	0,07	0,24	8,8	0,34	8,4			0,1	0,003	7,7	0,303
	XCF..-U1	3	10,70	0,5	1,78	10,3	0,41	9,9	$\left. \begin{matrix} 0,39 \\ 0,39 \\ 0,39 \\ 0,39 \end{matrix} \right\} \begin{matrix} +0,1 \\ -0,3 \end{matrix}$	$\left. \begin{matrix} 0,39 \\ 0,39 \\ 0,39 \\ 0,39 \end{matrix} \right\} \begin{matrix} +0,003 \\ -0,011 \end{matrix}$	0,1	0,003	9,2	0,36
	XCG..-U1	1,7	6,07	0,3	1,07	10,3	0,41	9,9			0,1	0,003	9,2	0,36
	XCK..-U1	1,2	4,28	0,2	0,71	10,3	0,41	9,9			0,1	0,003	9,2	0,36
	XCC..-U1	0,6	2,14	0,1	0,36	10,3	0,41	9,9			0,1	0,003	9,2	0,36
	XCH..-U1	0,35	1,24	0,07	0,24	10,3	0,41	9,9			0,1	0,003	9,2	0,36
	XCF..	1,05	3,74	0,16	0,57	12,2	0,48	10,2 ± 1,0	0,401 ± 0,039	0,6	0,023	8,4	0,33	
	XCG..	0,6	2,14	0,08	0,28	12,2	0,48	10,2 ± 0,9	0,401 ± 0,035	0,5	0,019	8,5	0,337	
	XCK..	0,42	1,49	0,056	0,19	12,2	0,48	10,3 ± 0,9	0,405 ± 0,035	0,5	0,019	8,7	0,342	
	XCC..	0,22	0,78	0,025	0,08	12,2	0,48	10,3 ± 0,9	0,404 ± 0,035	0,4	0,015	8,7	0,342	
	XCH..	0,13	0,46	0,02	0,07	12,2	0,48	10,4 ± 0,9	0,409 ± 0,035	0,4	0,015	8,8	0,346	
Width of lever 4,0 mm/0,16 in														
	XCF..	1,1	3,92	0,17	0,6	17,6	0,69	15,6 ± 1,1	0,614 ± 0,043	0,6	0,023	14	0,551	
	XCG..	0,7	2,49	0,09	0,32	17,6	0,69	15,6 ± 1,0	0,614 ± 0,039	0,5	0,019	14,1	0,555	
	XCK..	0,43	1,53	0,058	0,2	17,6	0,69	15,7 ± 1,0	0,618 ± 0,039	0,4	0,015	14,3	0,562	
	XCC..	0,23	0,82	0,026	0,09	17,6	0,69	15,7 ± 1,0	0,618 ± 0,039	0,4	0,015	14,3	0,562	
	XCH..	0,14	0,49	0,021	0,07	17,6	0,69	15,8 ± 1,0	0,622 ± 0,039	0,4	0,015	14,4	0,566	
Width of lever 4,0 mm/0,16 in														
	XCF..	1,05	3,74	0,16	0,57	12,2	0,48	10,2 ± 1,0	0,401 ± 0,039	0,6	0,023	8,4	0,33	
	XCG..	0,6	2,14	0,08	0,28	12,2	0,48	10,2 ± 0,9	0,401 ± 0,035	0,5	0,019	8,5	0,337	
	XCK..	0,42	1,49	0,056	0,19	12,2	0,48	10,3 ± 0,9	0,405 ± 0,035	0,5	0,019	8,7	0,342	
	XCC..	0,22	0,78	0,025	0,08	12,2	0,48	10,3 ± 0,9	0,404 ± 0,035	0,4	0,015	8,7	0,342	
	XCH..	0,13	0,46	0,02	0,07	12,2	0,48	10,4 ± 0,9	0,409 ± 0,035	0,4	0,015	8,8	0,346	
	XCF..	1,05	3,74	0,16	0,57	12,2	0,48	10,2 ± 1,0	0,401 ± 0,039	0,6	0,023	8,4	0,33	
	XCG..	0,6	2,14	0,08	0,28	12,2	0,48	10,2 ± 0,9	0,401 ± 0,035	0,5	0,019	8,5	0,337	
	XCK..	0,42	1,49	0,056	0,19	12,2	0,48	10,3 ± 0,9	0,405 ± 0,035	0,5	0,019	8,7	0,342	
	XCC..	0,22	0,78	0,025	0,08	12,2	0,48	10,3 ± 0,9	0,404 ± 0,035	0,4	0,015	8,7	0,342	
	XCH..	0,13	0,46	0,02	0,07	12,2	0,48	10,4 ± 0,9	0,409 ± 0,035	0,4	0,015	8,8	0,346	
	XCF..	1,1	3,92	0,17	0,6	17,6	0,69	15,6 ± 1,2	0,614 ± 0,047	0,6	0,023	14,1	0,555	
	XCG..	0,7	2,49	0,09	0,32	17,6	0,69	15,6 ± 1,1	0,614 ± 0,043	0,5	0,019	14,2	0,559	
	XCK..	0,43	1,53	0,058	0,2	17,6	0,69	15,7 ± 1,1	0,618 ± 0,043	0,4	0,015	14,4	0,566	
	XCC..	0,23	0,82	0,026	0,09	17,6	0,69	15,7 ± 1,1	0,618 ± 0,043	0,4	0,015	14,4	0,566	
	XCH..	0,14	0,49	0,021	0,07	17,6	0,69	15,8 ± 1,1	0,622 ± 0,043	0,4	0,015	14,5	0,57	
Width of roller 4,0 mm/0,16 in, for high temperature use -T1 lever														
	XCF..	1,3	4,62	0,17	0,6	17,6	0,69	15,6 ± 1,1	0,614 ± 0,043	0,6	0,023	14	0,551	
	XCG..	0,75	2,67	0,09	0,32	17,6	0,69	15,6 ± 1,0	0,614 ± 0,039	0,5	0,019	14,1	0,555	
	XCK..	0,6	2,13	0,058	0,2	17,6	0,69	15,7 ± 1,0	0,618 ± 0,039	0,4	0,015	14,3	0,562	
	XCC..	0,31	1,10	0,026	0,09	17,6	0,69	15,7 ± 1,1	0,618 ± 0,043	0,4	0,015	14,3	0,562	
	XCH..	0,22	0,78	0,021	0,07	17,6	0,69	15,8 ± 1,0	0,622 ± 0,039	0,4	0,015	14,4	0,566	
	XCF..	1,05	3,74	0,16	0,57	14,3	0,56	12,5 ± 1,1	0,49 ± 0,043	0,6	0,023	10,6	0,417	
	XCG..	0,6	2,13	0,08	0,28	14,3	0,56	12,5 ± 1,0	0,49 ± 0,039	0,5	0,019	10,7	0,421	
	XCK..	0,42	1,49	0,056	0,21	14,3	0,56	12,6 ± 1,0	0,5 ± 0,039	0,5	0,015	10,8	0,425	
	XCC..	0,22	0,78	0,025	0,11	14,3	0,56	12,6 ± 1,0	0,5 ± 0,039	0,4	0,015	10,8	0,425	
	XCH..	0,13	0,46	0,02	0,07	14,3	0,56	12,7 ± 1,0	0,5 ± 0,039	0,4	0,015	10,9	0,429	

Ordering Reference

Basic type	XCF	3	N	10,70 ozf	Example: XCF	4	3	V	-81	-J1	Z1
	XCG	1,7	N	6,07 ozf							
	XCK	1,2	N	4,28 ozf							
	XCC	0,6	N	2,14 ozf							
	XCH	0,35	N	1,24 ozf							
Circuits	No symbol, change-over (CO)										
	4	Normally closed (NC)									
	5	Normally open (NO)									
Terminals	3	Solder									
	4	Faston									
	5	Faston									
	8	PCB									
	9	PCB									
	10	PCB									
	11	PCB									
	12	PCB									
	13	PCB									
	14	PCB									
	15	PCB									
Version	No symbol, Housing material MF, Europe up to 85°C, UL up to 90°C										
	V	(High temperature 125°C), Housing material MF / Plunger PBT, Europe up to 125°C, UL up to 130°C									
	W	(High temperature 140°C), Housing material MF / Plunger PPS, Europe up to 140°C, UL up to 150°C									
Contacts	No symbol, Ag (Ag)										
	-81	μ profile Au 10 μm									
	-83	Ag + 0,2 μ Au (gold plated)									
Actuators	No symbol, plunger										
	-J1	Plain lever									
	-J2	Plain lever									
	-J5	Plain lever									
	-S1	Roller lever									
	-L1	Cam follower									
	-L6	Cam follower									
	-L9	Cam follower									
	-P5	Plastic lever									
	-P6	Plastic lever									
	-U1	Mushroom plunger									
	Other actuators on special request.										
Approvals	No symbol, ENEC										
	Z1	UL, CSA									

Thermoplastic Microswitches

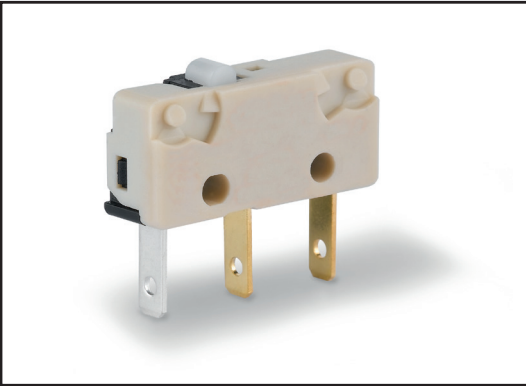

Circuit diagram

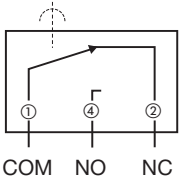

Dimension

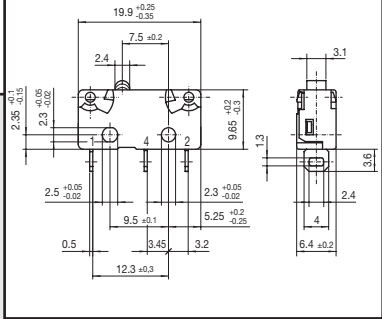

X4

Characteristics

- thermoplastic housing
- long mechanical and electrical life
- solder, PCB and faston terminals
- compliant to glow wire test IEC 60335-1, 4. ed.

Rating 250 VAC, 12 A max.

Dimensions (mm) 19,9 × 9,7 × 6,4

Actuator

- plunger
- plain levers
- cam follower lever
- roller levers

Approvals UL, cUL, CSA, ENEC, CQC

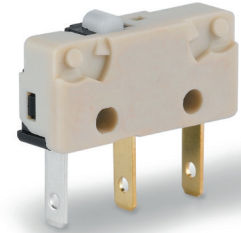

Preferred Range

Ordering Reference	Actuating Force		Operating pos.		Terminal	Circuit	Actuator	Contacts ENEC	Electrical rating	
	(N)	(ozf)	(mm)	(inch)					UL/CSA	
X4F303N1AA	3,30	11,87	8,4	0,3	Solder	CO	Plunger	Ag	12 (6) A	12 A
X4F305N1AA	3,30	11,87	8,4	0,3	Faston	CO	Plunger	Ag	12 (6) A	12 A
X4G303N1BB	2,00	7,19	8,4	0,3	Solder	CO	Plunger	Ag	6 (3) A	6 A
X4G305N1BB	2,00	7,19	8,4	0,3	Faston	CO	Plunger	Ag	6 (3) A	6 A
X4C303N1CC	0,75	2,70	8,4	0,3	Solder	CO	Plunger	Ag	3 (2) A	3 A
X4C305N1CC	0,75	2,70	8,4	0,3	Faston	CO	Plunger	Ag	3 (2) A	3 A

Specifications

Housing	Thermoplastic
Plunger	Thermoplastic
Mechanism	Snap-action system with stainless steel tension spring
Functions	CO (Change-over), NO (Normally Open), NC (Normally Closed)
Contacts	Fine silver (Ag), or 10 μm Gold (Au), microprofile
Terminals	Solder, faston, PCB, side-facing PCB and 'PCB terminals with 0,1" pitch
Temperature range °C	Between -40°C and +85°C
Mechanical life	10 ⁶ cycles minimum
Protection	Enclosure IP 40
Mounting	Side mounting or PCB
Actuators	Stainless steel
Contact carrier	CuZn or CuSn

Circuit diagram

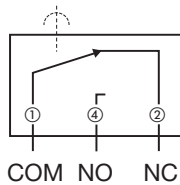

Actuating force/travel

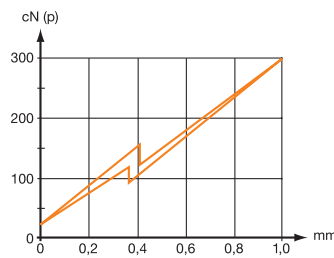

Contact force/travel

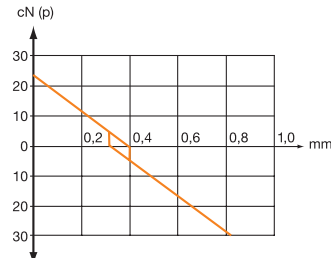

Dimensions

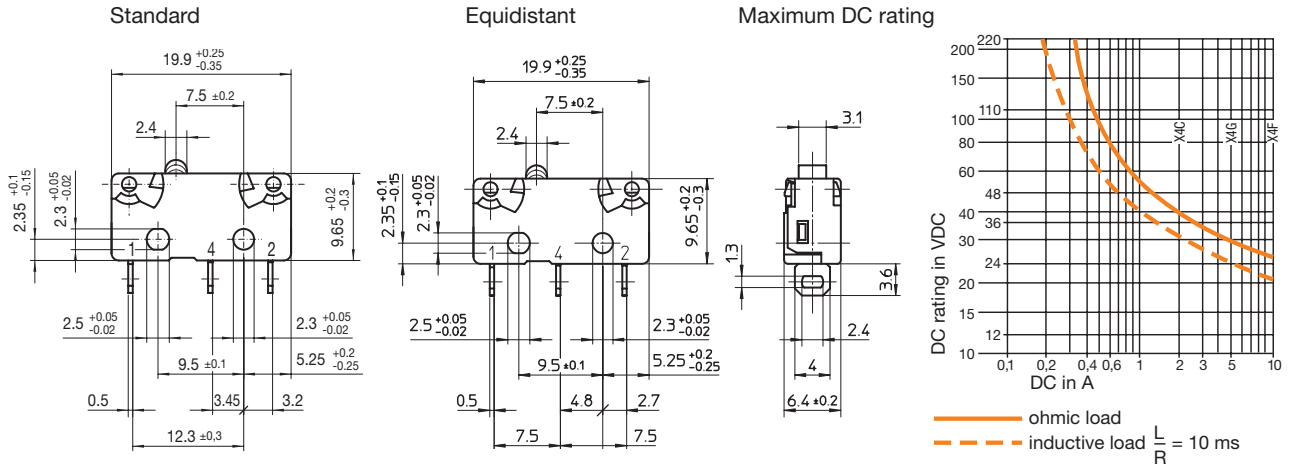

Recommended maximum electrical ratings

	Voltage (VAC)	Resistive load (A)		Motor load (A)		Approvals ENEC (A)		(VAC)	Approvals UL (VAC)	
		(A)	(A)	(A)	(A)	(A)	(VAC)			
X4F	250	12	6	12 (6)	1E4	250	12	125/250		
X4G	250	6	3	6 (3)	5E4	250	6	125/250		
X4C	250	3	2	3 (2)	5E4	250	3	125/250		

Breaking capacities in the tables refer to silver contacts

Operating Characteristics

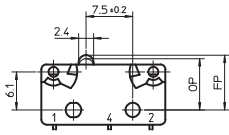
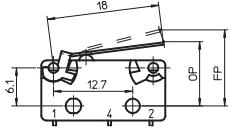
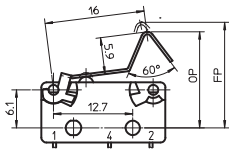
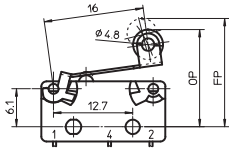
Actuator	Reference	Actuating Force		Release Force		Free Position		Operating Position		Movement Differential		Full Overtravel		
		Maximum (N)	(ozf)	Minimum (N)	(ozf)	Maximum (mm)	(in)	Maximum (mm)	(in)	Maximum (mm)	(in)	Maximum (mm)	(in)	
	X4F	3,30	11,87	0,550	1,978	8,8	0,35	8,4	$\left. \begin{array}{l} +0,1 \\ -0,3 \end{array} \right\} 0,33$	$\left. \begin{array}{l} +0,004 \\ -0,01 \end{array} \right\}$	0,2	0,008	7,7	0,303
	X4G	2,00	7,19	0,350	1,259	8,8	0,35	8,4			0,2	0,008	7,7	0,303
	X4C	0,75	2,70	0,130	0,468	8,8	0,35	8,4			0,2	0,008	7,7	0,303
	X4F	1,16	4,17	0,180	0,647	12,2	0,48	10,2 ±1,0	0,40 ±0,035	0,6	0,024	8,4	0,331	
	X4G	0,70	2,52	0,094	0,338	12,2	0,48	10,2 ±0,9	0,40 ±0,039	0,5	0,020	8,5	0,33	
	X4C	0,28	1,00	0,031	0,112	12,2	0,48	10,3 ±0,9	0,40 ±0,039	0,4	0,016	8,7	0,343	
Width of lever 4,0 mm/0,16 in														
	X4F	1,21	4,35	0,190	0,683	17,6	0,69	15,6 ±1,1	0,61 ±0,043	0,6	0,024	14,0	0,551	
	X4G	0,82	2,95	0,110	0,396	17,6	0,69	15,6 ±1,0	0,61 ±0,039	0,5	0,020	14,1	0,555	
	X4C	0,29	1,04	0,033	0,119	17,6	0,69	15,7 ±1,0	0,61 ±0,039	0,4	0,016	14,3	0,563	
Width of lever 4,0 mm/0,16 in														
	X4F	1,21	4,35	0,190	0,683	17,6	0,69	15,6 ±1,2	0,61 ±0,047	0,6	0,024	14,1	0,555	
	X4G	0,82	2,95	0,110	0,396	17,6	0,69	15,6 ±1,1	0,61 ±0,043	0,5	0,020	14,2	0,559	
	X4C	0,29	1,04	0,036	0,129	17,6	0,69	15,7 ±1,1	0,62 ±0,043	0,4	0,016	14,4	0,567	
Width of roller 4,0 mm/0,16 in														

Ordering Reference

Basic type	X4	Example: X4	F	3	03	K	1	A	A	J1	1																					
Operating force	F	extra high force	G	high force	C	low force																										
Circuits diagram	3	Change-over (CO)	4	Normally closed (NC)	5	Normally open (NO)																										
Terminals	03	Solder terminal	04	Faston terminal 2,8 × 0,5 mm DIN	05	Faston terminal 2,8 × 0,5 mm	08	PCB-terminal, length 4,5 mm	09	PCB-terminal, length 4,5 mm, (pitch 7,6)	10	PCB-terminal, formed to base	11	PCB-terminal, formed to lid	12	PCB-terminal, formed to base, (pitch 07,6)	13	PCB-terminal, formed to lid, (pitch 7,6)	14	PCB-terminal, length 3,5 mm	15	PCB-terminal, length 3,5 mm, (pitch 7,6)	21	Equidistant PCB-terminals, length 8,15 mm (pitch 7,5)	22	Equidistant PCB-terminals formed to base (pitch 7,5)	23	Equidistant PCB-terminals formed to lid (pitch 7,5)	24	Equidistant faston terminals 2,8 × 0,5 mm DIN (pitch 7,5)	25	Equidistant solder terminals (pitch 7,5)
Body	N	PA66GF25 for terminal types 03 to 15 only	P	PA66GF25 (pitch 7,5) for equidistant terminal types 21 to 25 only	R	PA66GF25 (pitch 7,5 with moulded pegs) for equidistant terminal types 22 and 23 only																										
Contacts material	1	Silver/Silver	8	Gold microprofile (Crosspoint) contacts	9	Gold-plated																										
UL/C-UL ratings	A	12 A, 125/250 VAC	B	6 A, 125/250 VAC	C	3 A, 125/250 VAC	D	0,1 A, 125 VAC	N	no approvals																						
EN/IEC ratings	A	12 (6) A, 250 V~ 1E4 T85 μ approved	B	6 (3) A, 250 V~ 5E4 T85 μ approved	C	3 (2) A, 250 V~ 5E4 T85 μ approved	F	10 (4) A, 250 V~ 1E4 T125 μ approved	L	1 A, 30 V = not approved	M	0,3 A, 30 V~ 1E4 not approved	N	no approvals																		
Type of actuators		No symbol, without lever	J1	Plain lever 18,0 mm (0,71 in)	L1	Cam follower 16,0 mm (0,63 in)	S1	Roller lever 16,0 mm (0,63 in)																								
		Other actuators and lengths available																														
Actuator position		No symbol, without lever	1	Lever above terminal 1	2	Lever above terminal 2																										

Sealed Microswitches



Circuit diagram

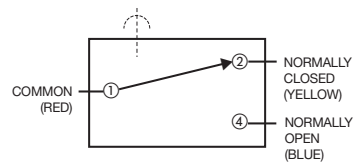

Dimension

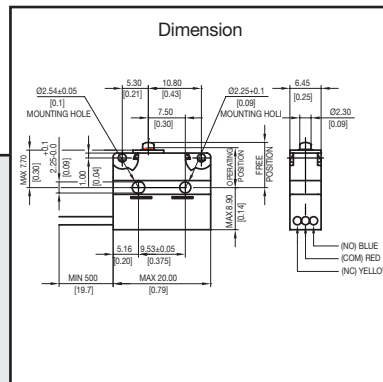

V4NS

- Characteristics
- sealed (IP67)
 - solder, 2,8 mm faston and PCB terminals
 - pre-wired option
 - compliant to glow wire test IEC 60335-1, 4. ed.

Rating 250 VAC, 5 A (3 A prewired UL)

Dimensions (mm) 20 × 10,3 × 6,4

- Actuator
- plunger
 - plain levers
 - roller levers
 - simulated roller lever/cam follower

Approvals UL, CSA, ENEC

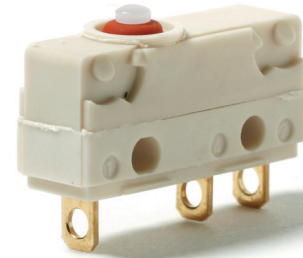

Preferred Range

Ordering Reference	Actuating Force (N)	Actuating Force (ozf)	Sealing	Operating pos. (mm)	Operating pos. (in)	Terminal	Circuit	Actuator	Contacts	Electrical rating
V4NST7UL	2,50	9,0	IP67	8,40	0,33	Solder	CO	Plain plunger	Ag	250 VAC, 5 A
V4NSUL	2,50	9,0	IP67	8,40	0,33	Pre-wired	CO	Plain plunger	Ag	250 VAC, 5 A
V4NST7Y1UL	0,90	3,2	IP67	10,6	0,42	Solder	CO	Straight lever	Ag	250 VAC, 5 A
V4NSY1UL	0,90	3,2	IP67	10,6	0,42	Pre-wired	CO	Straight lever	Ag	250 VAC, 5 A
V4NST7YRUL	0,90	3,2	IP67	15,6	0,62	Solder	CO	Roller lever	Ag	250 VAC, 5 A
V4NSYRUL	0,90	3,2	IP67	15,6	0,62	Pre-wired	CO	Roller lever	Ag	250 VAC, 5 A

Specifications

Housing	Flame-retardant glass-fibre reinforced nylon
Plunger	Polyacetal (POM)
Mechanism	Snap-action coil spring mechanism with stainless steel spring
Functions	Change-over, normally closed or normally open
Contacts	Silver
Terminals	Gold flashed
Temperature range °C	-40°C to +85°C
Mechanical life	3 × 10 ⁶ cycles minimum (impact free actuation)
Protection	IP67 enclosure, IP40 Flux proof terminal entries
Actuators	Plain lever, cam follower, Roller lever
Accessories	Insulating sheet - N04619, Clip-on terminal cover - TC102, Long overtravel actuator - QA4

Circuit diagram

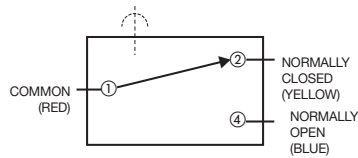

Dimension

V4NS

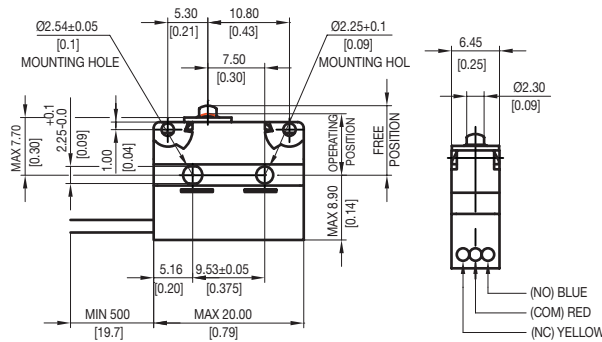

V4NST7

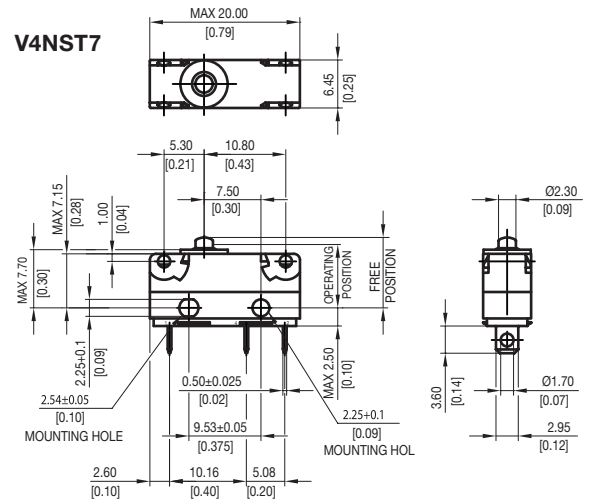

Recommended maximum electrical ratings

	Voltage (max)	Resistive load (A)	Motor load (A)	Approval
V4NST7UL	250 VAC	5 (0,75 pf)		UL 1054/CSA 22,2 No. 55 - 6,000 operations - 65°C EN61058-1, T85, 10,000 operations
	250 VAC	5	2	
	0 - 15 VDC	5	3	General rating - 50,000 operations (85°C)
	15 - 30 VDC	5	3	General rating - 50,000 operations (85°C)
V4NSUL	250 VAC	3 (0,75 pf)		UL 1054/CSA 22,2 No. 55 - 6,000 operations - 65°C EN61058-1, T85, 10,000 operations
	250 VAC	5	2	
	0 - 15 VDC	3	3	General rating - 50,000 operations (85°C)
	15 - 30 VDC	3	3	General rating - 50,000 operations (85°C)

Operating Characteristics

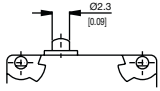
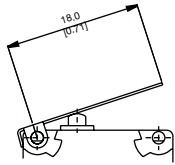
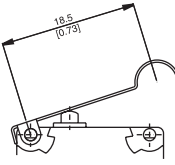
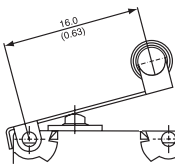
Actuator	Reference	Actuating Force Maximum		Release Force Minimum		Free Position Maximum		Operating Position		Movement Differential Maximum	
		(N)	(ozf)	(N)	(ozf)	(mm)	(in)	(mm)	(in)	(mm)	(in)
Plunger 	V4NST7UL	2,5	9,00	0,30	1,00	9,2	0,36	8,4 ± 0,3	0,33 ± 0,012	0,1	0,004
	V4NSUL	2,5	9,00	0,30	1,00	9,2	0,36	8,4 ± 0,3	0,33 ± 0,012	0,1	0,004
Y1 lever 	V4NST7Y1UL	0,9	3,20	0,07	0,25	13,2	0,52	10,6 ± 1,2	0,42 ± 0,05	0,4	0,016
	V4NSY1UL	0,9	3,20	0,07	0,25	13,2	0,52	10,6 ± 1,2	0,42 ± 0,05	0,4	0,016
Width of lever 4,0 mm/0,16 in											
YC lever 	V4NST7YCUL	0,9	3,20	0,07	0,25	16,1	0,70	13,3 ± 1,2	0,61 ± 0,05	0,4	0,016
	V4NSYCUL	0,9	3,20	0,07	0,25	16,1	0,70	13,3 ± 1,2	0,61 ± 0,05	0,4	0,016
Width of lever 4,0 mm/0,16 in											
YR lever 	V4NST7YRUL	0,9	3,20	0,07	0,25	17,8	0,70	15,6 ± 1,2	0,61 ± 0,05	0,4	0,016
	V4NSYRUL	0,9	3,20	0,07	0,25	17,8	0,70	15,6 ± 1,2	0,61 ± 0,05	0,4	0,016
Width of lever 4,0 mm/0,16 in											

Over travel: Plunger can be depressed flush with housing. The housing should not be used as an end stop.

Ordering Reference

Basic type	V4N	Example: V4N S T7 C2 Y1 0 X UL					
Type of sealing/ Overtravel	S B	Sealed IP67 Sealed IP67	standard travel with extended overtravel (0,5 mm)				
Terminals	No symbol, pre-wired 500 mm with cable box (V4NS/B only)						
	T7	Solder	2,95 × 0,5 × 3,6 long				
	T8	PCB	0,8 × 0,5 × 4,0 long				
	T9	Faston	2,8 × 0,5 × 8,1 long				
	T81	Formed PCB	0,8 × 0,5 × 3,8 long				
	T82	Formed PCB	0,8 × 0,5 × 3,8 long				
Circuit	No symbol, change-over						
	C2	Normally closed					
	C4	Normally open					
Actuators	No symbol, without lever						
	Y1	Plain lever	18,0 mm				
	Y2	Plain lever	25,0 mm				
	Y3	Plain lever	32,0 mm				
	YC	Cam follower lever	18,5 mm				
	YR	Roller lever	16,0 mm				
	QA	Long overtravel actuator available on request					
	Other actuators on special request						
Actuator Position	No symbol, without lever, or lever fitted at the end nearest to the Plunger						
	0	With lever fitted at end opposite to plunger					
Contact Material	No symbol, Fine silver						
	X	Gold alloy on silver palladium crosspoint					
Approvals	UL	UL, CSA and ENEC approval					
Special Features	<input type="checkbox"/> <input type="checkbox"/> <input type="checkbox"/> <input type="checkbox"/> Saia specialise in customer specific solutions. Additional product variants are available or can be provided. If your requirements cannot be satisfied from the options listed, please contact www.saia-burgess.com or your local SB outlet.						

V4NCS

V4NCS

- Characteristics
- wide variety of levers
 - peg mounting option
 - pre-wired option
 - sealed (IP6K7)
 - solder and faston terminals
 - PCB terminals

Rating 250 VAC, 5 A

Dimensions (mm) 20 × 10,3 × 6,4

- Actuator
- plunger
 - plain levers
 - roller levers
 - simulated roller levers

Approvals Automotive standard



Subminiature

Preferred Range

Ordering Reference	Actuating Force (N)	Actuating Force (ozf)	Sealing	Operating pos. (mm)	Operating pos. (in)	Terminal	Circuit	Actuator	Contacts	Electrical rating
V4NCS	2,5	8,992	Sealed IP6K7	8,40	0,331	Cable 500 mm	CO	Plunger	Ag	250 VAC, 5 A
V4NCSA1	0,9	3,237	Sealed IP6K7	10,80	0,425	Cable 500 mm	CO	Plain lever	Ag	250 VAC, 5 A
V4NCSAR	0,9	3,237	Sealed IP6K7	15,90	0,626	Cable 500 mm	CO	Roller lever	Ag	250 VAC, 5 A

Specifications

Housing	Glass fibre reinforced Polyamide (PA 6.6)
Plunger	Polyacetal POM/(PA 4,6)
Mechanism	Snap-action coil spring mechanism with stainless steel spring
Functions	Change-over, normally closed or normally open
Contacts	Fine Silver, Gold plate on silver, Gold alloy on silver palladium (crosspoint)
Terminals	Gold flashed
Temperature range °C	-40°C to +85°C (120°C option)
Mechanical life	3 × 10 ⁶ cycles minimum (impact free actuation)
Protection	IP67 enclosure, IP40 Flux proof terminal entries
Mounting	Side mounting (moulded mounting pegs on request)
Actuators	Plain lever, cam follower, roller lever, simulated roller (cam follower) lever
Accessories	Lug mounting frame, clip-on terminals cover, insulating sheet

Circuit diagram

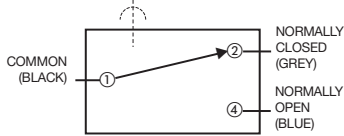

Dimensions

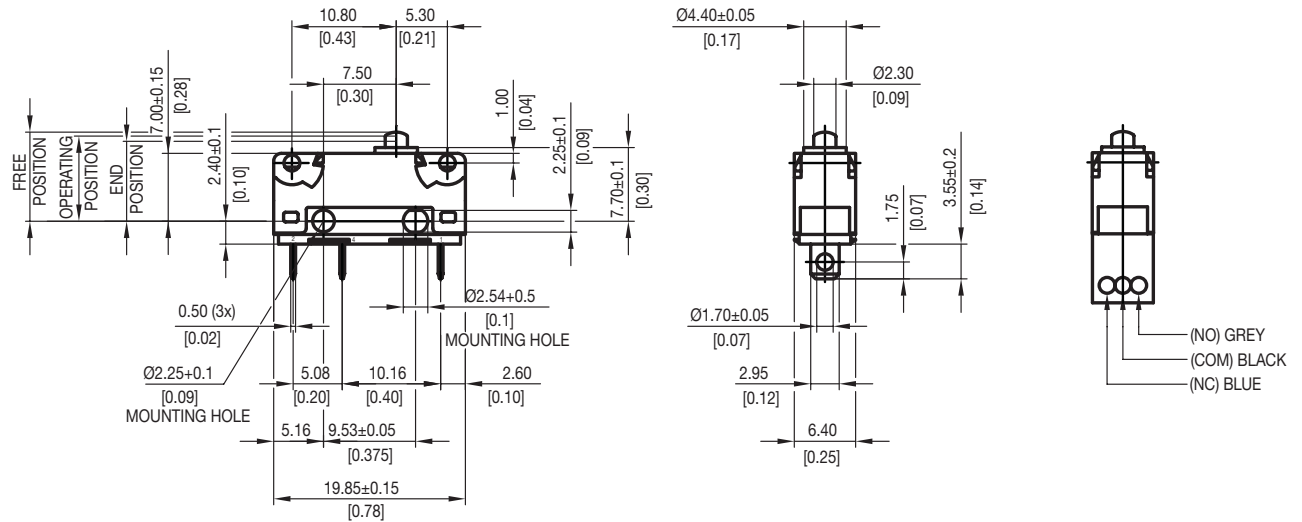

Prewired version with cable box
For type coding key please contact Saia

Standard cable FLY 0,5 mm² with max. outside diameter 1.8 mm
Standard cable box is K2

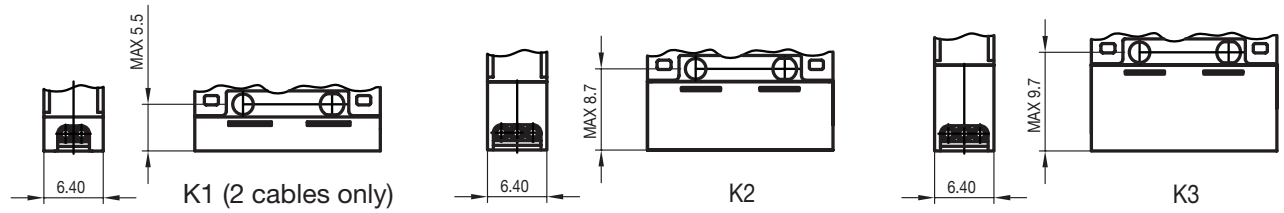

Recommended maximum electrical ratings

	Voltage (max)	Resistive load (A)	Motor load (A)	Approval
V4NCST	250 VAC	5	2	General rating (85° C)
	0 - 15 VDC	5	3	General rating (85° C)
	15 - 30 VDC	5	3	General rating (85° C)
V4NCS	250 VAC	5	2	General rating (85° C)
	0 - 15 VDC	3	3	General rating (85° C)
	15 - 30 VDC	3	3	General rating (85° C)

Operating Characteristics

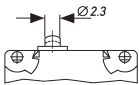
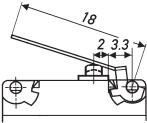
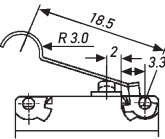
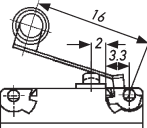
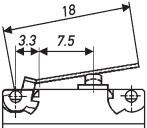
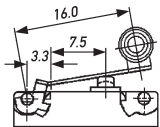
Actuator	Reference	Actuating Force		Release Force		Free Position Maximum		Operating Position		Movement Differential Maximum			
		(N)	(ozf)	(N)	(ozf)	(mm)	(in)	(mm)	(in)	(mm)	(in)		
Plunger 	V4NCS..	2,5	8,992	0,5	1,798	9,2	0,362	8,4	± 1,3	0,331	± 0,012	0,1	0,004
	V4NCSB..	2,5	8,992	0,5	1,798	9,7	0,382	8,9					
A1 Lever 	V4NCS..	0,9	3,237	0,1	0,359	13,4	0,527	10,8	± 1,3	0,425	± 0,051	0,4	0,016
	V4NCSB..	0,9	3,237	0,1	0,359	14,8	0,582	12,4					
Width of lever 4,0 (mm)/0,16 (in)													
AC Lever 	V4NCS..	0,9	3,237	0,1	0,359	16,1	0,634	13,4	± 1,3	0,527	± 0,051	0,4	0,016
	V4NCSB..	0,9	3,237	0,1	0,359	17,6	0,693	15,1					
Width of lever 4,0 (mm)/0,16 (in)													
AR Lever 	V4NCS..	0,9	3,237	0,1	0,359	18,1	0,712	15,9	± 1,2	0,626	± 0,047	0,4	0,016
	V4NCSB..	0,9	3,237	0,1	0,359	19,2	0,756	17,3					
Width of lever 4,0 (mm)/0,16 (in)													
A10 Lever 	V4NCS..	1,8	6,474	0,2	0,719	10,7	0,421	9,3	± 0,7	0,366	± 0,027	0,2	0,008
	V4NCSB..	1,8	6,474	0,2	0,719	11,5	0,453	10,1					
Width of lever 4,0 (mm)/0,16 (in)													
ARO Lever 	V4NCS..	1,8	6,474	0,2	0,719	15,8	0,622	14,7	± 0,6	0,579	± 0,023	0,2	0,008
	V4NCSB..	1,8	6,474	0,2	0,719	16,5	0,649	15,4					
Width of lever 4,0 (mm)/0,16 (in)													

Operating characteristics shown above are specified from mounting hole centres.

Over travel: Flush with case. (7,8 mm min) The case should not be used as an end stop.

Ordering Reference

Basic type	V4NC	Example: V4NC	S	T7	C4	A1	0	G
Type of sealing	S	Sealed IP6K7	standard travel					
	B	Sealed IP6K7	with extended overtravel (0,5 mm)					
Terminals	No symbol, pre-wired 500 mm with cable box (V4NCS/B only)							
	T7	Solder	2,95 × 0,5 × 3,55 long					
	T8	PCB	0,8 × 0,5 × 4,0 long					
	T9	Faston	2,8 × 0,5 × 9,5 long					
	T81	Formed PCB	0,8 × 0,5 × 3,8 long					
	T82	Formed PCB	0,8 × 0,5 × 3,8 long					
Circuit	No symbol, change-over							
	C2	Normally closed						
	C4	Normally open						
Actuators	No symbol, without lever							
	A1	Plain lever	18,0 mm					
	A2	Plain lever	25,0 mm					
	A3	Plain lever	32,0 mm					
	A7	Plain lever	60,0 mm					
	AC	Cam follower lever	18,5 mm (AC1)					
	AR	Roller lever	16,0 mm (AR1)					
	AP	Roller lever	17,9 mm (AR2)					
	Other actuators on special request							
Actuator Position	No symbol, without lever, or lever fitted at the end nearest to the Plunger							
	0	With lever fitted at end opposite to plunger						
Contact Material	No symbol, Ag							
	X	Gold alloy on silver palladium crosspoint (AUX)						
Special Features	/□□□□ Saia specialise in customer specific solutions. Additional product variants are available or can be provided. If your requirements cannot be satisfied from the options listed, please contact www.saia-burgess.com or your local SB outlet.							

Thermoset plastic Microswitches

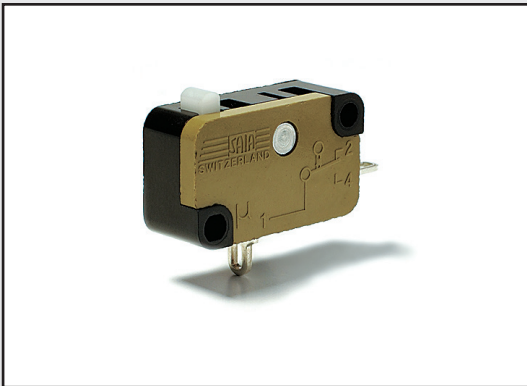

Circuit diagram

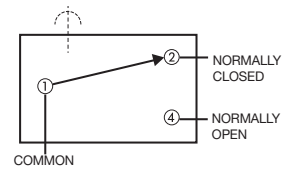

Dimension

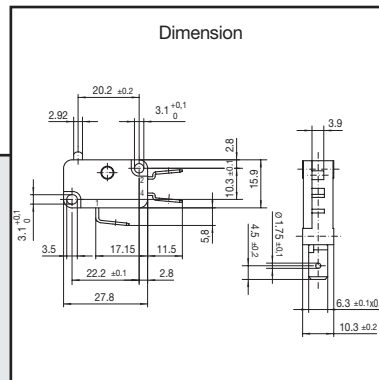

XG

- Characteristics
- wide range of forces and ratings
 - long mechanical and electrical life
 - solder, faston, PCB and screw terminals
 - compliant to IEC 60335-1, 4. ed.

Rating 250 VAC, 26 A max.

Dimensions (mm) 27,8 × 15,9 × 10,3

- Actuator
- plunger
 - plain levers
 - roller levers
 - simulated roller levers

Approvals ENEC, UL, cUL, CSA

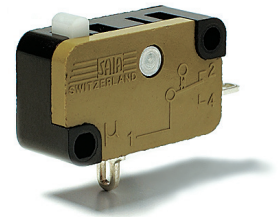

Preferred Range

Ordering Reference	Actuating Force		Operating pos.		Terminal	Circuit	Actuator	Contacts	Electrical rating	
	(N)	(ozf)	(mm)	(in)					ENEC	UL/CSA
XGG2-88Z1	3,20	11,43	14,7	0,57	Faston	CO	Plunger	Ag / AgNi10	16(6) A	15 A
XGG2-88-J23Z1	1,40	5,03	14,9	0,59	Faston	CO	Plain lever	Ag / AgNi10	16(6) A	15 A
XGG2-88-J26Z1	0,91	3,27	14,5	0,57	Faston	CO	Plain lever	Ag / AgNi10	16(6) A	15 A
XGG2-88-J27Z1	0,65	2,34	13,7	0,54	Faston	CO	Plain lever	Ag / AgNi10	16(6) A	15 A
XGG2-88-S20Z1	3,20	11,43	20,2	0,79	Faston	CO	Roller lever	Ag / AgNi10	16(6) A	15 A
XGG2-88-S21Z1	1,55	5,57	20,1	0,79	Faston	CO	Roller lever	Ag / AgNi10	16(6) A	15 A
XGG3-88Z1	3,20	11,43	14,7	0,57	Solder	CO	Plunger	Ag / AgNi10	16(6) A	15 A
XGG6-88Z1	3,20	11,43	14,7	0,57	Faston	CO	Plunger	Ag / AgNi10	16(6) A	15 A
XGC2-88Z1	0,80	2,86	14,7	0,57	Faston	CO	Plunger	Ag / AgNi10	12(6) A	10 A
XGC2-88-J23Z1	0,35	1,26	15,0	0,59	Faston	CO	Plain lever	Ag / AgNi10	12(6) A	10 A
XGC2-88-S20Z1	0,80	2,86	20,2	0,79	Faston	CO	Roller lever	Ag / AgNi10	12(6) A	10 A
XGC6-88Z1	0,80	2,86	14,7	0,57	Faston	CO	Plunger	Ag / AgNi10	12(6) A	10 A
XGK2-88Z1	1,50	5,36	14,7	0,57	Faston	CO	Plunger	Ag / AgNi10	12(6) A	12 A
XGK2-88-J26Z1	0,43	1,55	14,7	0,57	Faston	CO	Plain lever	Ag / AgNi10	12(6) A	12 A
XGK2-88-S21Z1	0,71	2,55	20,2	0,80	Faston	CO	Roller lever	Ag / AgNi10	12(6) A	12 A
XGK3-88Z1	1,50	5,36	14,7	0,57	Solder	CO	Plunger	Ag / AgNi10	12(6) A	12 A
XGK6-88Z1	1,50	5,36	14,7	0,57	Faston	CO	Plunger	Ag / AgNi10	12(6) A	12 A
XG02-88Z1	1,20	4,29	14,5	0,57	Faston	CO	Plunger	Ag / AgNi10	16(6) A	15 A
XG02-88-J27Z1	0,25	0,90	13,6	0,54	Faston	CO	Plain lever	Ag / AgNi10	16(6) A	15 A
XG02-88-S20Z1	1,20	4,29	20,1	0,79	Faston	CO	Roller lever	Ag / AgNi10	16(6) A	15 A
XG06-88Z1	1,20	4,29	14,5	0,57	Faston	CO	Plunger	Ag / AgNi10	16(6) A	15 A

Specifications

Housing	Melamine-Formaldehyd. Thermosetting
Plunger	POM, PPS, MF depending on temperature/type
Mechanism	Snap-action, single pole beryllium bronze blade mechanism with wiping contacts
Functions	Change-over, normally-closed (except XGG and XGK) or normally-open
Contacts	Fine silver (Ag), silver nickel (AgNi10), gold-plated (Au), silver cadmium oxide (AgCdO)
Terminals	Solder, faston, screw, PCB and side mounting PCB terminals. RAST 5 terminals (5,0 mm pitch)
Temperature range °C	-40°C to +150°C
Mechanical life	2 x 10 ⁵ cycles minimum, 5 x 10 ⁶ cycles maximum (Actuation: sinusoidal and maximum up to 80% of the overtravel)
Protection	Enclosure IP40
Mounting	Side mounting via mounting holes
Actuators	Stainless steel

Circuit diagram

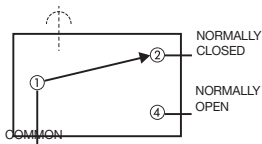

Actuating force/travel

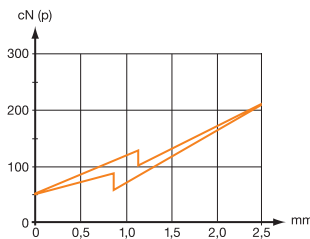

Contact force/travel

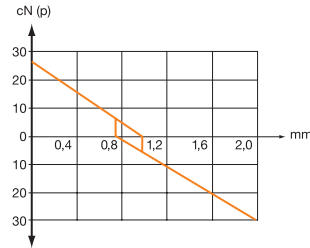

Dimensions

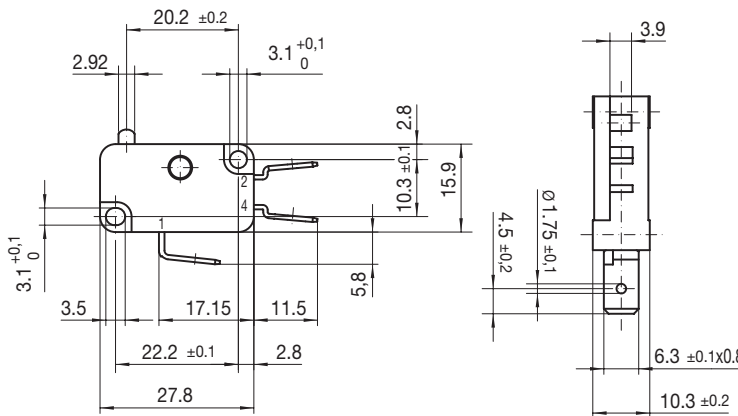

Maximum DC rating

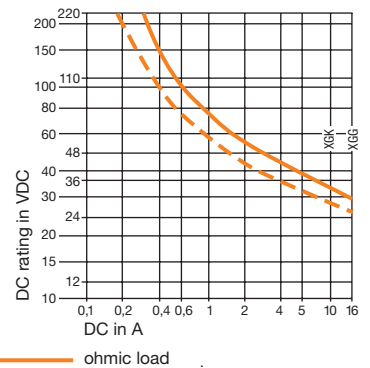

Recommended maximum electrical ratings

	Voltage (VAC)	Approvals ENEC	UL	(VAC)		Voltage (VAC)	Approvals ENEC	UL	(VAC)		
XGG...-88	250	16 (6)	5E4	15 A	125/250	XGT...-86	250	26 (10)	25E3	25A	125/250
XGA...-88	250	16 (6)	5E4	15 A	125/250	XGD...-86	250	22 (6)	5E4	21A	125/250
XGM...-88	250	16 (6)	5E4	15 A	125/250	XGA...-86	250	20 (8)	5E4	15A	125/250
XGO...-88	250	16 (6)	5E4	15 A	125/250	XGM...-86	250	20 (8)	5E4	15A	125/250
XGB...-88	250	12 (6)	5E4	12 A	125/250	XGO...-86	250	20 (8)	5E4	15A	125/250
XGC...-88	250	12 (6)	5E4	10 A	125/250	XGA...-86	400	10 (6)	5E4	-	-
XGH...-88	250	12 (6)	5E4	10 A	125/250	XGG...-86	400	10 (6)	5E4	-	-
XGK...-88	250	12 (6)	5E4	12 A	125/250	XGM...-86	400	10 (6)	5E4	-	-
XG....-88	400	3 (2)	5E4			XGO...-86	400	10 (6)	5E4	-	-

Operating Characteristics

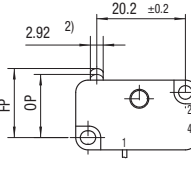
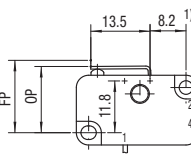
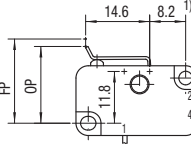
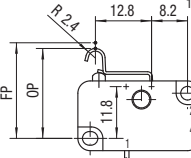
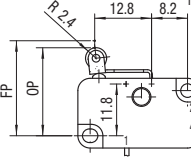
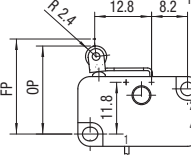
Actuator	Reference	Actuating Force		Release Force		Free Position FP		Operating Position OP		Movement Differential		Total travelled position	
		Maximum (N)	(ozf)	Minimum (N)	(ozf)	Maximum (mm)	(in)	(mm)	(in)	Maximum (mm)	(in)	(mm)	(in)
	XGG..	3,2	11,43	0,4	1,43	15,75	0,62	14,7	$\left. \begin{array}{l} 0,57 \\ 0,57 \\ 0,57 \\ 0,57 \\ 0,57 \\ 0,57 \\ 0,57 \\ 0,57 \\ 0,57 \\ 0,57 \end{array} \right\} \begin{array}{l} +0,2 \\ -0,4 \end{array} \left. \begin{array}{l} \\ \\ \\ \\ \\ \\ \\ \\ \\ \\ \end{array} \right\} \begin{array}{l} +0,007 \\ -0,015 \end{array}$	0,35	0,013	13,2	0,519
	XGA..	3,2	11,43	0,6	2,14	15,75	0,62	14,7		0,15	0,006	13,2	0,519
	XGM..	2	7,14	0,5	1,79	15,6	0,61	14,5		0,35	0,013	13,7	0,539
	XGO..	1,2	4,29	0,1	0,36	15,6	0,61	14,5		0,35	0,013	13,7	0,539
	XGK..	1,5	5,36	0,2	0,71	15,75	0,62	14,7		0,35	0,013	13,2	0,519
	XGB..	1,5	5,36	0,3	1,07	15,75	0,62	14,7		0,15	0,006	13,2	0,519
	XGC..	0,8	2,86	0,1	0,36	15,75	0,62	14,7		0,15	0,006	13,2	0,519
	XGH..	0,45	1,61	0,05	0,18	15,6	0,61	14,5		0,35	0,013	13,7	0,539
	XGT	3,2	11,43	0,6	2,14	15,75	0,62	14,7		0,15	0,006	13,2	0,519
	XGD..	1,7	6,07	0,15	0,54	15,75	0,62	14,7		0,15	0,006	13,2	0,519
	XGG..	3,2	11,43	0,36	1,29	16,5	0,64	15,1	$\left. \begin{array}{l} 0,59 \\ 0,59 \\ 0,59 \\ 0,59 \\ 0,59 \\ 0,59 \\ 0,59 \\ 0,59 \end{array} \right\} \pm 0,5 \left. \begin{array}{l} \\ \\ \\ \\ \\ \\ \\ \end{array} \right\} \pm 0,019$	0,4	0,015	14	0,551
	XGA..	3,2	11,43	0,54	1,93	16,5	0,64	15,1		0,2	0,007	14	0,551
	XGM..	2	7,14	0,45	1,61	16,5	0,64	15		0,4	0,015	14,4	0,566
	XGO..	1,2	4,29	0,09	0,34	16,5	0,64	15		0,4	0,015	14,4	0,566
	XGK..	1,5	5,36	0,18	0,64	16,5	0,64	15,1		0,4	0,015	14	0,551
	XGB..	1,5	5,36	0,27	0,96	16,5	0,64	15,1		0,2	0,007	14	0,551
	XGC..	0,8	2,86	0,09	0,32	16,5	0,64	15,1		0,2	0,007	14	0,551
	XGH..	0,45	1,61	0,04	0,14	16,5	0,64	15		0,4	0,015	14,4	0,566
Width of lever 7 mm/0,28 in – also available with width 4 mm/0,16 in													
	XGG..	2,6	9,29	0,32	1,14	19,2	0,75	17,5	$\left. \begin{array}{l} 0,68 \\ 0,68 \\ 0,68 \\ 0,68 \\ 0,68 \\ 0,68 \\ 0,68 \\ 0,68 \end{array} \right\} \pm 0,7 \left. \begin{array}{l} \\ \\ \\ \\ \\ \\ \\ \end{array} \right\} \pm 0,027$	0,45	0,017	16,4	0,645
	XGA..	2,6	9,29	0,48	1,71	19,2	0,75	17,5		0,2	0,007	16,4	0,645
	XGM..	1,65	5,89	0,4	1,43	19,2	0,75	17,3		0,45	0,017	16,9	0,665
	XGO..	1	3,57	0,08	0,29	19,2	0,75	17,3		0,45	0,017	16,9	0,665
	XGK..	1,25	4,46	0,16	0,57	19,2	0,75	17,5		0,45	0,017	16,4	0,645
	XGB..	1,25	4,46	0,24	0,86	19,2	0,75	17,5		0,2	0,007	16,4	0,645
	XGC..	0,65	2,32	0,08	1,29	19,2	0,75	17,5		0,2	0,007	16,4	0,645
	XGH..	1,37	1,32	0,04	0,14	19,2	0,75	17,3		0,45	0,017	16,9	0,665
Width of lever 7 mm/0,28 in													
	XGG..	3,2	11,43	0,38	1,36	21,8	0,85	20,5	$\left. \begin{array}{l} 0,81 \\ 0,81 \\ 0,81 \\ 0,81 \\ 0,81 \\ 0,81 \\ 0,81 \\ 0,81 \end{array} \right\} \pm 0,6 \left. \begin{array}{l} \\ \\ \\ \\ \\ \\ \\ \end{array} \right\} \pm 0,023$	0,4	0,015	19,5	0,767
	XGA..	3,2	11,43	0,85	3,04	21,8	0,85	20,5		0,2	0,007	19,5	0,767
	XGM..	2	7,14	0,48	1,71	21,8	0,85	20,3		0,4	0,015	19,8	0,779
	XGO..	1,2	4,29	0,09	0,32	21,8	0,85	20,1		0,4	0,015	19,8	0,779
	XGK..	1,5	5,36	0,19	0,68	21,8	0,85	20,5		0,4	0,015	19,5	0,767
	XGB..	1,5	5,36	0,29	1,04	21,8	0,85	20,5		0,2	0,007	19,5	0,767
	XGC..	0,8	2,86	0,09	0,32	21,8	0,85	20,5		0,2	0,007	19,5	0,767
	XGH..	0,45	1,61	0,04	0,14	21,8	0,85	20,3		0,4	0,015	19,8	0,779
Width of lever 7 mm/0,28 in													
	XGG..	3,2	11,43	0,37	1,32	21,8	0,85	20,2	$\left. \begin{array}{l} 0,79 \\ 0,79 \\ 0,79 \\ 0,79 \\ 0,79 \\ 0,79 \\ 0,79 \\ 0,79 \end{array} \right\} \pm 0,7 \left. \begin{array}{l} \\ \\ \\ \\ \\ \\ \\ \end{array} \right\} \pm 0,027$	0,4	0,015	19,3	0,759
	XGA..	3,2	11,43	0,56	2	21,8	0,85	20,2		0,2	0,007	19,3	0,759
	XGM..	2	7,14	0,47	1,68	21,8	0,85	20,1		0,4	0,015	19,7	0,775
	XGO..	1,2	4,29	0,09	0,32	21,8	0,85	20,1		0,4	0,015	19,7	0,775
	XGK..	1,5	5,36	0,18	0,64	21,8	0,85	20,2		0,4	0,015	19,3	0,759
	XGB..	1,5	5,36	0,28	1	21,8	0,85	20,2		0,2	0,007	19,3	0,759
	XGC..	0,8	2,86	0,09	0,32	21,8	0,85	20,2		0,2	0,007	19,3	0,759
	XGH..	0,45	1,61	0,04	0,14	21,8	0,85	20,1		0,4	0,015	19,7	0,775
Width of roller 6,6 mm/0,26 in													
	XGG..	3,2	11,43	0,37	1,32	21,8	0,85	20,2	$\left. \begin{array}{l} 0,79 \\ 0,79 \\ 0,79 \\ 0,79 \\ 0,79 \\ 0,79 \\ 0,79 \\ 0,79 \end{array} \right\} \pm 0,7 \left. \begin{array}{l} \\ \\ \\ \\ \\ \\ \\ \end{array} \right\} \pm 0,027$	0,4	0,015	19,3	0,759
	XGA..	3,2	11,43	0,56	2	21,8	0,85	20,2		0,2	0,007	19,3	0,759
	XGM..	2	7,14	0,05	1,68	21,8	0,85	20,1		0,4	0,015	19,7	0,775
	XGO..	1,2	4,29	0,09	0,32	21,8	0,85	20,1		0,4	0,015	19,7	0,775
	XGK..	1,5	5,36	0,18	0,64	21,8	0,85	20,2		0,4	0,015	19,3	0,759
	XGB..	1,5	5,36	0,28	1	21,8	0,85	20,2		0,2	0,007	19,3	0,759
	XGC..	0,8	2,86	0,09	0,32	21,8	0,85	20,2		0,2	0,007	19,3	0,759
	XGH..	0,45	1,61	0,04	0,14	21,8	0,85	20,1		0,4	0,015	19,7	0,775
Width of roller 6,6 mm/0,26 in													

¹⁾ Lever distance 8,2 (0,32) for lever position –.20, lever position (–J20, L20, S20, M20)
Lever distance 14,0 (0,55) for lever position –.40, lever position (–J40, L40, S40, M40)

²⁾ 2,65 mm for switch type XGH, XGO, XGM

³⁾ For high temperature T125°C/T 150°C (ENEC, UL)

Ordering Reference

Basic type	XGG..	3,2 N	11,43 ozf	Example: XGG	4	2	A	-88	J20	Z1
	XGA..	3,2 N	11,43 ozf							
	XGM..	2,0 N	7,14 ozf							
	XGO..	1,2 N	4,29 ozf							
	XGK..	1,5 N	5,36 ozf							
	XGB..	1,5 N	5,36 ozf							
	XGC..	0,8 N	2,86 ozf							
	XGH..	0,45 N	1,61 ozf							
	XGD..	1,7 N	6,07 ozf							
	XGT..	3,2 N	11,43 ozf							

Circuit	No symbol, change-over (CO)
4	Normally closed (NC)
5	Normally open (NO)

Terminals	2	Faston	6,3 × 0,8
	3	Solder	1,7 × 3,2
	4	Faston	1 × 2,8 × 0,5 DIN
	5	Faston	1 × 2,8 × 0,5
	6	Faston	4,8 × 0,5
	7	Screw	
	8	Faston	1 × 2,8 × 0,8 DIN
	9	Faston	1 × 2,8 × 0,8
	10	Faston	4,8 × 0,8
	11	Faston	2 × 2,8 × 0,8
	12	Short solder	∅ 2,3
	13	Print bent (lid)	
	14	Print bent (base)	
	15	Rast 5	6,3 × 0,8
	19	Short solder	∅ 1,7

Other types of terminals are available on request

Version	ENEC	Number of operations at rated load		
		UL	Europe	UL
	No symbol, T85	T90	50,000	6,000
A	T85	T90	50,000	100,000
W	T150	T150	50,000	6,000
AW	T150	T150	50,000	100,000
B	T85	T90	10,000	6,000
V	T125	T130	50,000	6,000
AV	T125	T130	50,000	100,000
C	T85	T90	25,000	6,000

Contacts	-88	Ag / AgNi10
	-81	Gold-plated 4 µm (Au) on Ag
	-86	Ag / Ag CdO

Actuators	No symbol, plunger		
J20 ¹⁾	J40 ²⁾	Plain lever	13,5 mm
J22 ¹⁾	J42 ²⁾	Plain lever	24,0 mm
J23 ¹⁾	J43 ²⁾	Plain lever	27,8 mm
J27 ¹⁾	J47 ²⁾	Plain lever	60,0 mm
M20 ¹⁾	M40 ²⁾	Plain lever formed	14,7 mm
L20 ¹⁾	L40 ²⁾	Cam follower	12,8 mm
L21 ¹⁾	L41 ²⁾	Cam follower	26,2 mm
S20 ¹⁾	S40 ²⁾	Roller lever	12,8 mm
T20 ¹⁾	T40 ²⁾	Roller lever, 150°C version	12,8 mm

Other actuators available on request

- ¹⁾ Lever distance 8,2 (0,32) for lever position –20, lever position (–J20, L20, S20, M20)
²⁾ Lever distance 14,0 (0,55) for lever position –40, lever position (–J40, L40, S40, M40)

Approvals	No symbol, ENEC
Z1	UL, CSA

Thermoplastic Microswitches

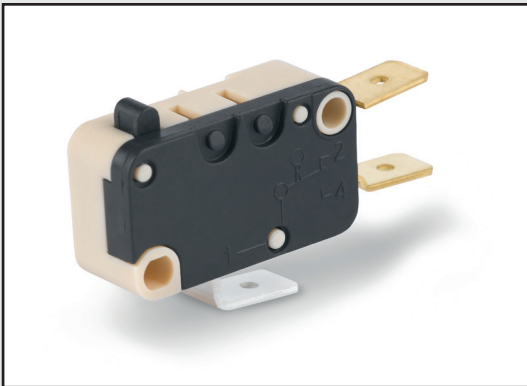

Circuit diagram

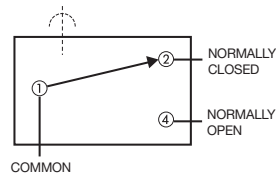

Dimension

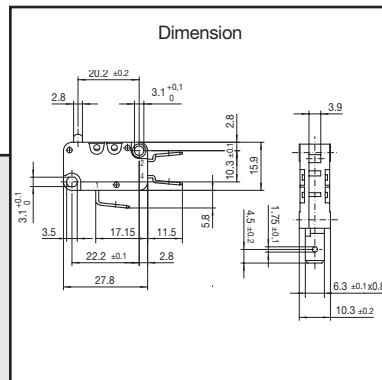

X3

- Characteristics
- 8 mm creepage and clearance distance to the actuator
 - long mechanical and electrical life
 - solder, faston and PCB terminal
 - compliant to glow wire requirements IEC 60335-1, 4. ed.

Rating 250 VAC, 21 A max.

Dimensions (mm) 27,8 × 15,9 × 10,3

- Actuator
- plunger
 - straight lever
 - simulated roller levers
 - roller levers

Approvals UL, cUL, CSA, ENEC, CQC

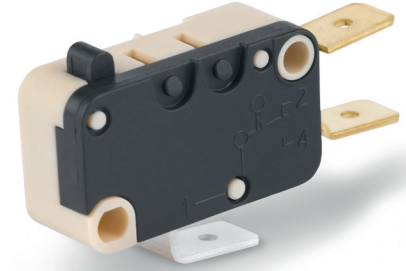

Preferred Range

Ordering Reference	Actuating Force		Operating pos.		Terminal	Circuit	Actuator	Contacts	Electrical rating	
	(N)	(ozf)	(mm)	(Inch)					ENEC	UL/CSA
X3M302N2KA	1,60	5,55	14,7	0,58	Faston	CO	Plunger	Ag/AgNi10	16 (6) A	20,5 A
X3M302N2NAJ32	0,88	3,15	15,6	0,59	Faston	CO	Plain lever	Ag/AgNi10	16 (6) A	20,5 A
X3M302N2NAJ62	0,57	2,05	14,8	0,58	Faston	CO	Plain lever	Ag/AgNi10	16 (6) A	20,5 A
X3M302N2NAT02	2,00	7,19	20,2	0,80	Faston	CO	Roller lever	Ag/AgNi10	16 (6) A	20,5 A
X3M303N2KA	1,60	5,73	14,7	0,58	Solder	CO	Plunger	Ag/AgNi10	16 (6) A	20,5 A
X3M306N2KA	1,60	5,73	14,7	0,58	Faston	CO	Plunger	Ag/AgNi10	16 (6) A	20,5 A
X3C302N2LB	0,80	2,88	14,7	0,58	Faston	CO	Plunger	Ag/AgNi10	10 (3) A	12 A
X3C302N2LBJ32	0,35	1,26	15,0	0,59	Faston	CO	Plain lever	Ag/AgNi10	10 (3) A	12 A
X3C303N2LB	0,80	2,88	14,7	0,58	Solder	CO	Plunger	Ag/AgNi10	10 (3) A	12 A
X3C306N2LB	0,80	2,88	14,7	0,58	Faston	CO	Plunger	Ag/AgNi10	10 (3) A	12 A
X3L302N6DD	1,50	5,40	14,7	0,58	Faston	CO	Plunger	Ag/AgCdO	21 (8) A	21 A
X3L303N6DD	1,50	5,40	14,7	0,58	Solder	CO	Plunger	Ag/AgCdO	21 (8) A	21 A

Specifications

Housing	Thermoplastic
Plunger	Thermoplastic
Mechanism	Snap-action, single pole beryllium bronze blade mechanism with wiping contacts
Contact carrier	Brass
Contacts	Fine silver (Ag), silver nickel (AgNi10), gold-plated (Au), silver cadmium oxide (AgCd0)
Terminals	Solder, Faston and RAST 5 terminals
Temperature range °C	Between -40°C and +125°C
Mechanical life	minimum cycles X3L: 10 ⁵ / X3M: 10 ⁶ / X3C: 2 x 10 ⁶ (Actuation: sinusoidal and maximum up to 80% of the overtravel)
Protection	Enclosure IP40
Mounting	Side mounting via mounting holes
Actuators	Stainless steel (lever)

Circuit diagram

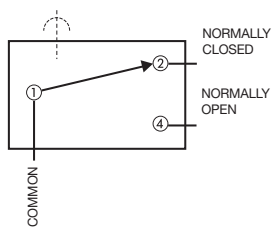

Actuating force/travel

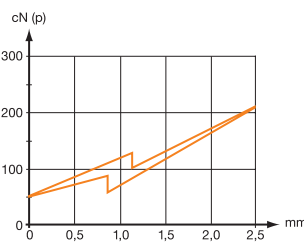

Contact force/travel

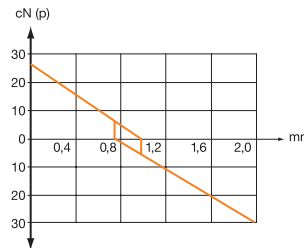

Dimensions

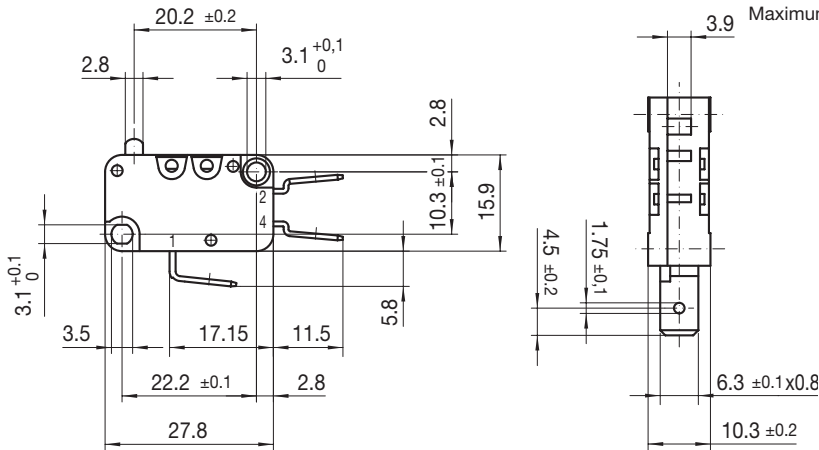

Maximum DC rating

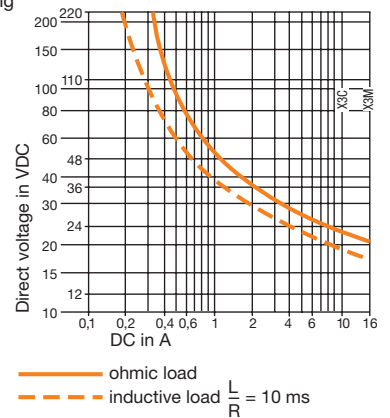

Recommended maximum electrical ratings

	Voltage (VAC)	Resistive load (A)	Motor load (A)	Approvals ENEC		Approvals UL		Motor load
				(A)	(VAC)	(A)	(VAC)	
X3M	250	16	6	16 (6)	5E4	20,5	250	1½ HP
X3C	250	10	3	10 (3)	5E4	12	250	½ HP
						12	125	¼ HP
X3L	250	21	8	21 (8)	1E4	21	250	2 HP
						21	125	1 HP

Current breaking capacities in the tables refer to Ag/AgNi10 contacts with the exception of X3L Ag/AgCd0

Operating Characteristics

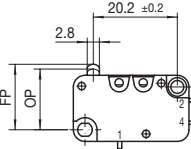
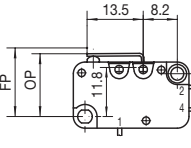
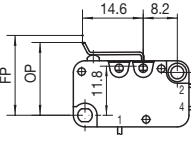
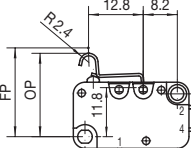
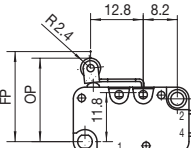
Actuator	Reference	Actuating Force		Release Force		Free FP Position		Operating OP Position		Movement Differential		Full overtravel Position		
		Maximum (N)	(ozf)	Minimum (N)	(ozf)	Maximum (mm)	(in)	(mm)	(in)	Maximum (mm)	(in)	Maximum (mm)	(in)	
	X3C	0,80	2,88	0,050	0,179	15,75	0,620	14,7	$\left. \begin{matrix} 0,58 \\ +0,2 \\ -0,4 \end{matrix} \right\} 0,58$	$\left. \begin{matrix} +0,008 \\ -0,016 \end{matrix} \right\} 0,25$	0,25	0,009	13,2	0,519
	X3M	1,60	5,76	0,200	0,719	15,75	0,620	14,7						
	X3L	1,50	5,40	0,150	0,540	15,75	0,620	14,7						
	X3C ..	0,80	2,88	0,045	0,162	16,50	0,649	15,1 ± 0,5	0,59 ± 0,019	0,35	0,014	14,0	0,550	
	X3M ..	2,00	7,19	0,180	0,647	16,50	0,649	15,1 ± 0,5	0,59 ± 0,019	0,35	0,014	14,0	0,550	
	X3L ..	1,90	6,83	0,140	0,500	16,50	0,649	15,1 ± 0,5	0,59 ± 0,019	0,35	0,014	14,0	0,550	
Width of lever 7,0 mm/0,28 in – also available with width 4 mm/0,16 in														
	X3C ..	0,65	2,34	0,045	0,162	19,20	0,755	17,5 ± 0,7	0,69 ± 0,028	0,35	0,014	16,4	0,646	
	X3M ..	1,65	5,93	0,160	0,576	19,20	0,755	17,5 ± 0,7	0,69 ± 0,028	0,35	0,014	16,4	0,646	
	X3L ..	1,55	5,58	0,140	0,500	19,20	0,755	17,5 ± 0,7	0,69 ± 0,028	0,35	0,014	16,4	0,646	
Width of lever 7,0 mm/0,28 in														
	X3C ..	0,80	2,88	0,045	0,162	21,80	0,858	20,5 ± 0,6	0,81 ± 0,024	0,35	0,014	19,5	0,768	
	X3M ..	2,00	7,19	0,190	0,683	21,80	0,858	20,5 ± 0,6	0,81 ± 0,024	0,35	0,014	19,5	0,768	
	X3L ..	1,90	6,83	0,140	0,500	21,80	0,858	20,5 ± 0,6	0,81 ± 0,024	0,35	0,014	19,5	0,768	
Width of lever 7,0 mm/0,28 in														
	X3C ..	0,80	2,88	0,045	0,162	21,80	0,858	20,2 ± 0,7	0,79 ± 0,028	0,35	0,014	19,3	0,760	
	X3M ..	2,00	7,19	0,190	0,683	21,80	0,858	20,2 ± 0,7	0,79 ± 0,028	0,35	0,014	19,3	0,760	
	X3L ..	1,90	6,83	0,140	0,500	21,80	0,858	20,2 ± 0,7	0,79 ± 0,028	0,35	0,014	19,3	0,760	
Width of roller 6,6 mm/0,26 in														

Ordering Reference

Basic type	X3	Microswitch according to DIN 41635, Design A	Example: X3	M	3	02	K	2	A	A	J0	2
Operating force	M	Standard force 1										
	L	Standard force 2										
	C	Low force										
Circuit diagram	3	Change-over (CO)										
	4	Normally closed (NC)										
	5	Normally open (NO)										
Terminals	02	Plug terminal 6,3 × 0,8 mm	13	PCB-terminal, Formed to lid								
	03	Solder terminal	14	PCB-terminal, Formed to base								
	06	Plug terminal 4,8 × 0,5 mm	15	Plug terminal RAST 5 6,3 × 0,8 mm								
	10	Plug terminal 4,8 × 0,8 mm										
	12	Solder terminal, short										
Body	N	PA66GF25										
Contacts materials	2	Silver/AgNi10										
	6	AgCdO										
	8	Gold plated										
UL/C-UL ratings	A	20,5 A, 125/250 VAC 15 A, 125/250 VAC, 100'000 cy. 1½ HP, 250 VAC, ½ HP, 125 VAC	M	6 A, 125/250 VAC ⅓ HP, 250 VAC, ⅓ HP, 125 VAC								
	D	21 A, 125/250 VAC 2 HP, 250 VAC, 1 HP, 125 VAC	N	No approvals								
	E	21 A, 125/250 VAC 15 A, 125/250 VAC, 100'000 cy. 2 HP, 250 VAC, 1 HP, 125 VAC	P	20,5 A, 125/250 VAC 1½ HP, 250 VAC, ½ HP, 125 VAC								
	K	20,5 A, 125/250 VAC 1½ HP, 250 VAC, ½ HP, 125 VAC	Q	¼ HP, 250 VDC, ½ HP, 125 VDC 12 A, 125/250 VAC ⅓ HP, 250 VAC, ⅓ HP, 125 VAC								
	L	12 A, 125/250 VAC ⅓ HP, 250 VAC, ⅓ HP, 125 VAC	R	¼ A, 250 VDC, ½ A, 125 VDC 6 A, 125/250 VAC ⅓ HP, 250 VAC, ⅓ HP, 125 VAC ¼ A, 250 VDC, ½ A, 125 VDC								
EN/IEC ratings	A	16 (6) A, 250 V~ 5E4 T125 μ approved										
	B	10 (3) A, 250 V~ 5E4 T125 μ approved										
	C	6 (3) A, 250 V~ 5E4 T125 μ approved										
	D	21 (8) A, 250 V~ 1E4 T105 μ approved										
	M	no approvals										
Type of actuator		No symbol, without lever										
	J0 to J9	Straight lever (width 7 mm)										
	L0 to L9	Simulated roller lever										
	M0 to M9	Customer specified lever (KV)										
	P0 to P9	Straight lever (width 4 mm)										
	T0 to T9	Roller lever										
		Other actuators and lengths available										
Actuator position		No symbol, without lever										
	2	Rear lever										
	4	Front lever										

340

- Characteristics
- wiping contacts, leaf spring mechanism
 - 3 mm contact gap
 - compliant to glow wire requirements IEC 60335-1, 4. ed. as optional item

Rating 250 VAC, 16 A max.

Dimensions 28,8 × 20,4 × 10,1

- Actuator
- plunger
 - roller lever
 - plain levers
 - simulated roller lever
 - moulded lever

Approvals ENEC, UL



Popular Products

Ordering Reference	Actuating Force (N)	Actuating Force (ozf)	Operating pos. (mm)	Operating pos. (in)	Terminal (mm)	Contact Gap	Actuator	Contacts	Electrical rating ENEC	UL/CSA
343B120350N0	4,9	17,50	14,7 +0,3 -0,6	0,58	+0,01 -0,02	Faston	3	Plunger	AgCd0	16 (3) A, 250 VAC 12 A, 125–250 VAC

Specifications

Housing	Glass-filled flame retardant Nylon 6,6
Plunger	Glass-filled flame retardant Nylon 6,6
Mechanism	Snap action, single pole leaf spring mechanism
Functions	Change-over, Normally open, Normally closed
Contacts	Silver
Terminals	Solder, Faston and Rast 5 terminals
Temperature range	-10°C to +85°C
Mechanical life	10 ⁷ cycles minimum (3 mm gap 10 ⁶) (impact-free actuation)
Protection	IP40 (enclosure)
Mounting	Side mounting
Actuators	Plunger, plain lever, roller lever

Circuit diagram

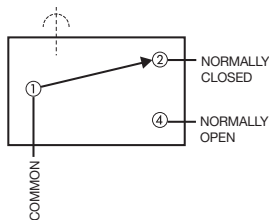

Dimensions

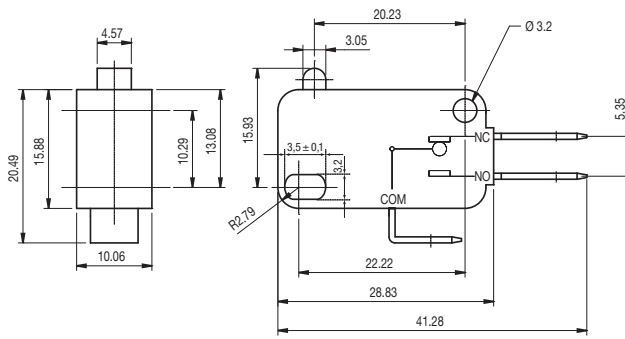

342
Solder

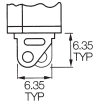

345
4,75 × 0,5
Faston

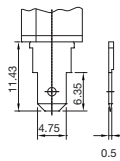

348
Rast 5
Faston

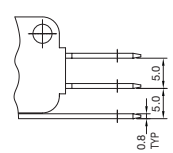
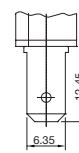

343
6,35 × 0,8
Faston

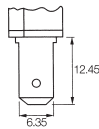

346
4,75 × 0,8
Faston

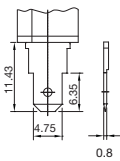

Recommended maximum electrical ratings

Versions	ENEC	UL/CSA	Motor load
3 mm Wide gap	16(3) A, 250 VAC, 50 E3, T85	12 A, 125-250 VAC, T85	½ HP

Operating Characteristics 34_120350

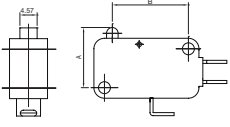
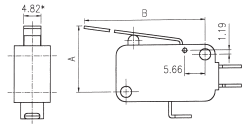
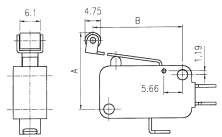
Actuator	Reference	Actuating Force		Release Force		Free Position		Operating Position		Movement Differential		Full Overtravel Position	
		Maximum (N)	(ozf)	Minimum (N)	(ozf)	Maximum (mm)	(in)	(mm)	(in)	Maximum (mm)	(in)	Position (mm)	(in)
Plunger 	34_120350	4,90	17,50	1,20	4,32	15,93	0,63	14,70 +0,3/-0,6	0,58 +0,01/-0,02	0,76	0,03	13,0	0,51
Plain lever (Back position) 	ZD0	4,90	17,50	1,20	4,32	17,00	0,67	15,20 +/-0,5	0,60 +/-0,02	0,80	0,03	14,1	0,56
	ZD1	3,60	12,95	0,63	2,27	18,80	0,74	15,70 +/-0,8	0,62 +/-0,03	1,20	0,05	13,7	0,54
	ZD2	1,40	5,04	0,18	0,65	26,70	1,05	14,60 +/-3,0	0,57 +/-0,12	4,60	0,18	11,1	0,44
Roller lever 	ZDS0	4,90	17,50	1,20	4,32	22,20	0,87	20,60 +/-0,7	0,81 +/-0,03	0,80	0,03	19,5	0,77
	ZDS1	3,60	12,95	0,52	1,87	24,20	0,95	21,20 +/-0,9	0,83 +/-0,04	1,10	0,04	19,5	0,77

Ordering Reference

Basic type	34	Example: 34 2 B 40 75 NO ZD0											
Terminal type	2 solder 3 6,35 × 0,8 fast-on 5 4,75 × 0,5 fast-on 6 4,75 × 0,8 fast-on 8 6,35 × 0,8 Rast 5												
	B	No symbol, standard material compliant to glow wire requirements IEC 60335-1, 4. ed.											
Contact gap	120 3 mm												
Operating force	350 490 g (3 mm gap)												
Circuit	No symbol, change-over NO Normally open NC Normally closed												
Actuator	No symbol, plunger ZD0 Plain lever 22,56 mm ZD1 Plain lever 33,90 mm ZD2 Plain lever 84,43 mm ZDS0 Roller lever 19,67 mm ZDS1 Roller lever 31,70 mm												

Table of preferred products

Snap-action Microswitches	Type	Preferred Products	Preferred Products	Page
Subminiature	XC	XCG3Z1	XCG8-81-J1Z1	17
		XCG3-J1Z1	XCG8-81-S1Z1	
		XCG3-S1Z1	XCF3Z1	
		XCG5Z1	XCF3-J1Z1	
		XCG5-J1Z1	XCF3-S1Z1	
		XCG5-S1Z1	XCG3-U1Z1	
		XCG8Z1	XCG4-U1Z1	
		XCG8-81Z1	XCG8-U1Z1	
Miniature	X4	X4F303N1AA	X4G305N1BB	22
		X4F305N1AA	X4C303N1CC	
		X4G303N1BB	X4C305N1CC	
Miniature	V4NS	V4NST7UL	V4NSUL	27
		V4NST7Y1UL	V4NSY1UL	
		V4NST7YRUL	V4NSYRUL	
Miniature	V4NCS	V4NCS		31
		V4NCSA1		
		V4NCSAR		
Miniature	XG	XGG2-88Z1	XGK2-88Z1	36
		XGG2-88-J23Z1	XGK2-88-J26Z1	
		XGG2-88-J26Z1	XGK2-88-S21Z1	
		XGG2-88-J27Z1	XGK3-88Z1	
		XGG2-88-S20Z1	XGK6-88Z1	
		XGG2-88-S21Z1	XGO2-88Z1	
		XGG3-88Z1	XGO2-88-J27Z1	
		XGG6-88Z1	XGO2-88-S20Z1	
		XGC2-88Z1	XGO6-88Z1	
		XGC2-88-J23Z1		
		XGC2-88-S20Z1		
		XGC6-88Z1		
		Miniature	X3	
X3M302N2KAJ32	X3C302N2LBJ32			
X3M302N2KAJ62	X3C303N2LB			
X3M302N2KAT02	X3C306N2LB			
X3M303N2KA	X3L302N6DD			
X3M306N2KA	X3L303N6DD			
340	343B120350NO		46	

Headquarters

6/F, 12 Science Park East Avenue,
Hong Kong Science Park
Shatin, NT, **Hong Kong**
Phone: +852 2663 6688
e-mail: sales@johnsonelectric.com

Sales Offices

Asia

China

No. 1, Lane 10800, Songze
Avenue, Qingpu Industrial Zone
Shanghai 201700
Phone: +86 21 5882 2880

Sin Er Industrial Zone
Shajing Town, Baoan District
Shenzhen 518125
Phone: +86 755 2990 0001

Japan

TFT Build West 5F, 3-4-10 Ariake
Kouto-Ku, **Tokyo** 135-8072
Phone: +81 355 20 0070

Singapore

1 Maritime Square #09-01,
Harbour Front Centre
Singapore 099253
Phone: +65 6224 7570

South Korea

Fine Building, 4th Floor, 701-6, Banpo-
Dong, Seocho-Ku
Seoul 137-808
Phone: 82 2 518 8341

Europe

France

10 Bld. Louise Michel
92230 **Gennevilliers**
Phone: +33 1 46 88 07 70
ipg-sfr@johnsonelectric.com

Germany

Weissenpferd 9
58553 **Halver**
Phone: +49 2353 911 0
ipg-sde@johnsonelectric.com

Italy

Via Cadamosto 3
20094 **Corsico**, Milano
Phone: +39 02 4869 21
ipg-sit@johnsonelectric.com

Switzerland

Bahnhofstrasse 18
3280 **Murten**
Phone: +41 26 672 71 11
ipg-sch@johnsonelectric.com

The Netherlands

Hanzeweg 12c
2803 MC **Gouda**
Phone: +31 1825 43 174
ipg-sbn@johnsonelectric.com

United Kingdom

Unit 5, Woodstock Way,
Baldon Business Park, **Baldon**
Tyne & Wear, NE35 9PF
Phone: +44 844 811 2130
ipg-suk@johnsonelectric.com

Americas

USA

10 Progress Drive
Shelton, CT 06484
Phone: +1 203 447 5362

801 Scholz Drive
P.O. Box 427
Vandalia, OH 45377
Phone: +1 937 454 2363

Brazil

Av. Papa Joao Paulo I - 1174
Guarulhos, CEP 07170-350
Sao Paulo
Phone: +55 11 2431 5600

Johnson Electric Group

6/F, 12 Science Park East Avenue,
Hong Kong Science Park, Shatin, NT
Hong Kong

Tel: +852 2663 6688

e-mail: sales@johnsonelectric.com

Website: www.johnsonelectric.com