

A New Series of Easy-to-use and Tough E2EG Models with a Yellow Indicator

- New series of TL-X2C1-GE models with improved performance over the previous TL-X-E models. Also, in addition to the E2EG, the new series of E2E/E2E2 models are available.
- Ideal for a variety of applications.
- With a metal connector that can be tightened securely and a cord protector.
- With an easy-to-see yellow indicator, deeper mounting holes, and tightening flats for wrenches.
- The new series of E2EG models includes M8 plug-in connector models.

Note: Detailed information is available for the replacement of conventional models. Ask your OMRON representative for a copy of OMRON's E2EG/E2E/E2E2 Conversion Guide.



Ordering Information

E2EG

DC 3-wire/Pre-wired

Shield	Size	Sensing distance	Output configuration	Part number	
				NPN	PNP
Shielded	M8	1.5 mm	NO	E2EG-X1R5C1	E2EG-X1R5B1
			NC	E2EG-X1R5C2	E2EG-X1R5B2
	M12	2 mm	NO	E2EG-X2C1	E2EG-X2B1
			NC	E2EG-X2C2	E2EG-X2B2
	M18	5 mm	NO	E2EG-X5C1	E2EG-X5B1
			NC	E2EG-X5C2	E2EG-X5B2
	M30	10 mm	NO	E2EG-X10C1	E2EG-X10B1
			NC	E2EG-X10C2	E2EG-X10B2
Unshielded	M8	2 mm	NO	E2EG-X2MC1	E2EG-X2MB1
			NC	E2EG-X2MC2	E2EG-X2MB2
	M12	5 mm	NO	E2EG-X5MC1	E2EG-X5MB1
			NC	E2EG-X5MC2	E2EG-X5MB2
	M18	10 mm	NO	E2EG-X10MC1	E2EG-X10MB1
			NC	E2EG-X10MC2	E2EG-X10MB2
	M30	18 mm	NO	E2EG-X18MC1	E2EG-X18MB1
			NC	E2EG-X18MC2	E2EG-X18MB2

DC 3-wire/M12 Plug-in

Shield	Size	Sensing distance	Output configuration	Part number	
				NPN	PNP
Shielded	M8	1.5 mm	NO	E2EG-X1R5C1-M1	E2EG-X1R5B1-M1
			NC	E2EG-X1R5C2-M1	E2EG-X1R5B2-M1
	M12	2 mm	NO	E2EG-X2C1-M1	E2EG-X2B1-M1
			NC	E2EG-X2C2-M1	E2EG-X2B2-M1
	M18	5 mm	NO	E2EG-X5C1-M1	E2EG-X5B1-M1
			NC	E2EG-X5C2-M1	E2EG-X5B2-M1
	M30	10 mm	NO	E2EG-X10C1-M1	E2EG-X10B1-M1
			NC	E2EG-X10C2-M1	E2EG-X10B2-M1
Unshielded	M8	2 mm	NO	E2EG-X2MC1-M1	E2EG-X2MB1-M1
			NC	E2EG-X2MC2-M1	E2EG-X2MB2-M1
	M12	5 mm	NO	E2EG-X5MC1-M1	E2EG-X5MB1-M1
			NC	E2EG-X5MC2-M1	E2EG-X5MB2-M1
	M18	10 mm	NO	E2EG-X10MC1-M1	E2EG-X10MB1-M1
			NC	E2EG-X10MC2-M1	E2EG-X10MB2-M1
	M30	18 mm	NO	E2EG-X18MC1-M1	E2EG-X18MB1-M1
			NC	E2EG-X18MC2-M1	E2EG-X18MB2-M1

DC 3-wire/M8 Plug-in

Shield	Size	Sensing distance	Output configuration	Part number	
				NPN	PNP
Shielded	M8	1.5 mm	NO	E2EG-X1R5C1-M3	E2EG-X1R5B1-M3
Unshielded	M8	2 mm	NO	E2EG-X2MC1-M3	E2EG-X2MB1-M3

Specifications

■ Ratings/Characteristics

E2EG-Xj Cj /Bj DC 3-wire Models

Item	E2EG-X1R5 Cj /Bj	E2EG-X2M Cj /Bj	E2EG-X2 Cj /Bj	E2EG-X5M Cj /Bj	E2EG-X5 Cj /Bj	E2EG-X10M Cj /Bj	E2EG-X10 Cj /Bj	E2EG-X18M Cj /Bj	
Size	M8		M12		M18		M30		
Type	Shielded	Unshielded	Shielded	Unshielded	Shielded	Unshielded	Shielded	Unshielded	
Sensing distance	1.5 mm ±10%	2 mm ±10%	2 mm ±10%	5 mm ±10%	5 mm ±10%	10 mm ±10%	10 mm ±10%	18 mm ±10%	
Supply voltage (operating voltage range) (see note)	12 to 24 VDC, ripple (p-p): 10% max., (10 to 40 VDC)								
Current consumption	13 mA max.								
Sensing object	Magnetic metals (refer to "Engineering Data" for non-magnetic metals)								
Setting distance	0 to 1.2 mm	0 to 1.6 mm	0 to 1.6 mm	0 to 4.0 mm	0 to 4.0 mm	0 to 8.0 mm	0 to 8.0 mm	0 to 14.0 mm	
Standard object (mild steel)	8 x 8 x 1 mm	12 x 12 x 1 mm	12 x 12 x 1 mm	15 x 15 x 1 mm	18 x 18 x 1 mm	30 x 30 x 1 mm	30 x 30 x 1 mm	54 x 54 x 1 mm	
Differential travel	10% max. of sensing distance								
Response frequency	2.0 kHz	0.8 kHz	1.5 kHz	0.4 kHz	0.6 kHz	0.2 kHz	0.4 kHz	0.1 kHz	
Operation (with sensing object approaching)	C1/B1 models: Load ON C2/B2 models: Load OFF								
Control output (switching capacity)	200 mA max.		200 mA max. (300 mA max. at 55°C or less) NPN or PNP open collector						
Circuit protection	Reverse connection protection, surge absorber, load short-circuit protection								
Indicator	Operation indicator (yellow LED)								
Ambient temperature	Operating: -40°C to 70°C (with no icing)								
Ambient humidity	Operating: 35% to 95%								
Temperature influence	±15% max. of sensing distance at 23°C in temperature range of -40°C to 70°C ±10% max. of sensing distance at 23°C in temperature range of -25°C to 70°C								
Voltage influence	±1% max. of sensing distance in rated voltage range ±15%								
Residual voltage	M8: 2.0 V max. (under load current of 200 mA with cable length of 2 m) M12 to M30: 2.0 V max. (under load current of 300 mA with cable length of 2 m)								
Insulation resistance	50 MΩ min. (at 500 VDC) between current carry parts and case								
Dielectric strength	1,000 VAC for 1 min between current carry parts and case								
Vibration resistance	Destruction: 10 to 55 Hz, 1.5-mm double amplitude for 2 hrs each in X, Y, and Z directions								
Shock resistance	Destruction: 500 m/s ² (approx. 50G) for 10 times each in X, Y, and Z directions		Destruction: 1,000 m/s ² (approx. 50G) for 10 times each in X, Y, and Z directions 500 m/s ² (approx. 50G) for E2E-X5M						
Enclosure rating	IEC IP67								
Weight	Pre-wired	Approx. 45 g		Approx. 120 g		Approx. 160 g		Approx. 270 g	
	Connector	---	Approx. 25 g			Approx. 45 g		Approx. 125 g	Approx. 124 g
Material	Case	Stainless steel		Brass					
	Sensing surface	PBT							

Note: E2EG models with an M18 or M30 connector operate at a non-smoothed, all-wave rectified, mean voltage range of 24 VDC ±20%.

Engineering Data

E2EG

Operating Range (Typical)

Shielded Models

E2EG-Xj Cj /Bj

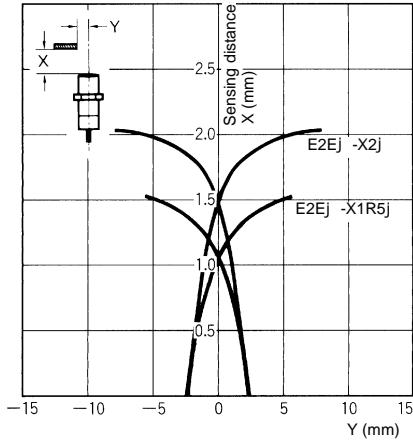

E2EG-Xj Cj /Bj

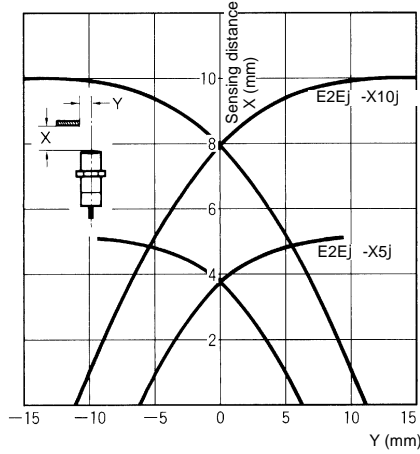

Unshielded Models

E2EG-Xj MCj /Bj

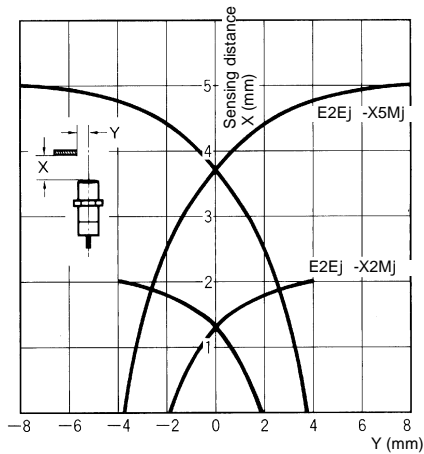

E2EG-Xj MCj /Bj

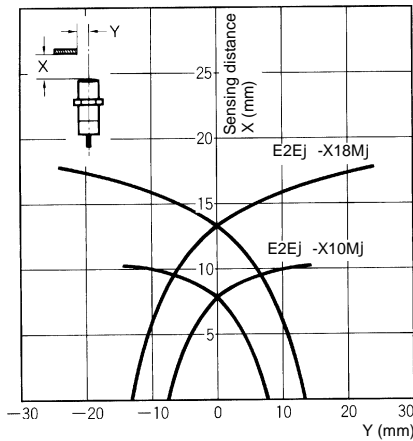

Sensing Distance vs. Sensing Object (Typical)

E2EG-X1R5Cj /Bj

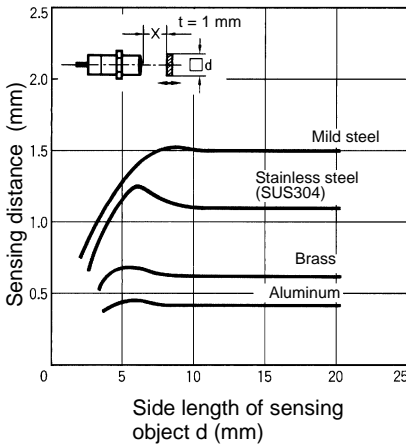

E2EG-X2Cj /Bj

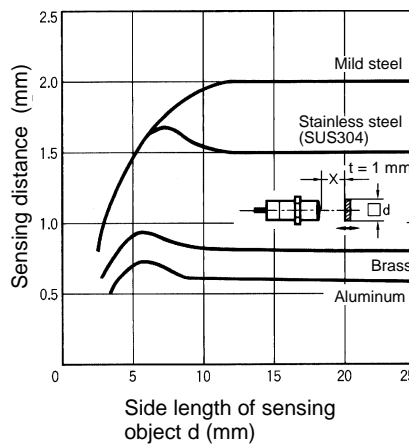

E2EG-X5Cj /Bj

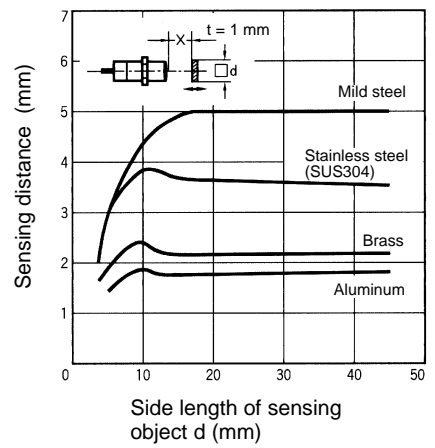

E2EG-X10Cj /Bj

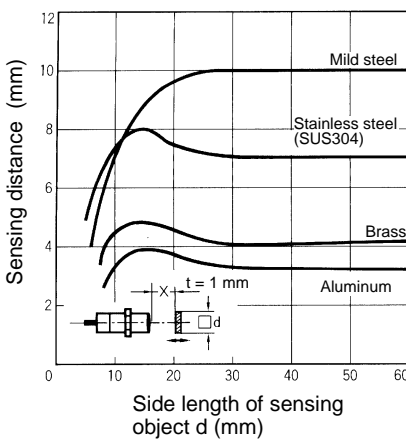

E2EG-X2MCj /Bj

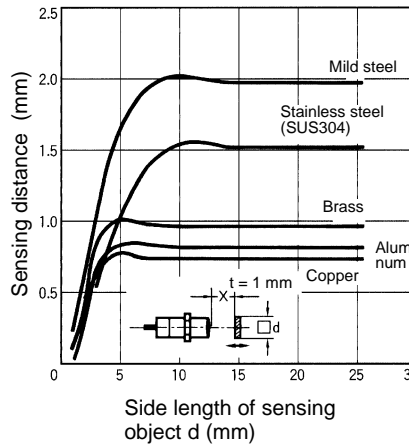

E2EG-X5MCj /Bj

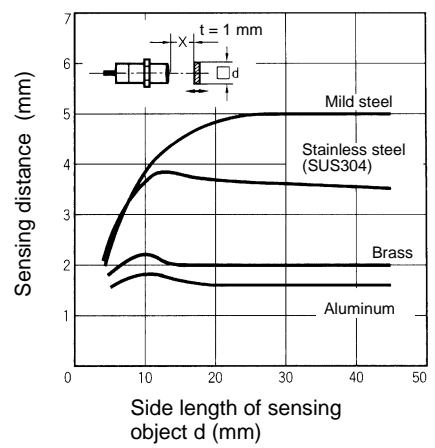

E2EG-X10MCj /Bj

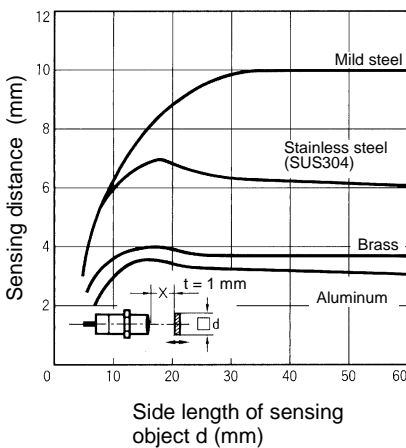

E2EG-X18MCj /Bj

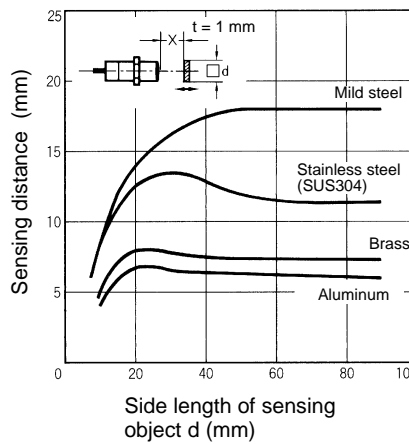

Operation

Output Circuits

E2EG

E2EG-Xj Cj

NPN Open Collector Output

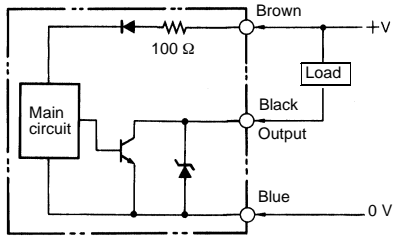

E2EG-Xj Bj

PNP Open Collector Output

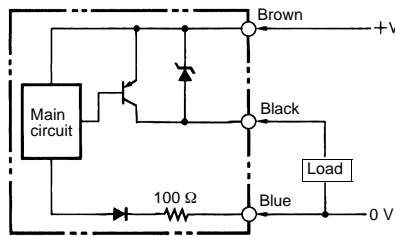

Operating Chart

E2EG

E2EG-Xj Cj /Bj

NPN/PNP Open Collector Output

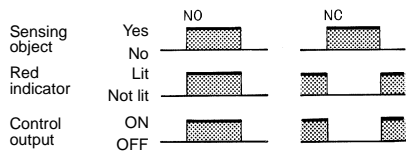

Dimensions

Note: All units are in millimeters unless otherwise indicated.

E2EG

Type			DC 3-wire	
			Part number	Figure no.
Pre-wired	Shielded	M8	E2EG-X1R5Cj /Bj	1
		M12	E2EG-X2Cj /Bj	3
		M18	E2EG-X5Cj /Bj	5
		M30	E2EG-X10Cj /Bj	7
	Unshielded	M8	E2EG-X2MCj /Bj	2
		M12	E2EG-X5MCj /Bj	4
		M18	E2EG-X10MCj /Bj	6
		M30	E2EG-X18MCj /Bj	8
Connector (M12)	Shielded	M8	E2EG-X1R5Cj -M1/Bj -M1	9
		M12	E2EG-X2Cj -M1/Bj -M1	11
		M18	E2EG-X5Cj -M1/Bj -M1	13
		M30	E2EG-X10Cj -M1/Bj -M1	15
	Unshielded	M8	E2EG-X2MCj -M1/Bj -M1	10
		M12	E2EG-X5MCj -M1/Bj -M1	12
		M18	E2EG-X10MCj -M1/Bj -M1	14
		M30	E2EG-X18MC1-M1/B1-M1	16
Connector (M8)	Shielded	M8	E2EG-X1R5C1-M3/B1-M3	17
	Unshielded		E2EG-X2MC1-M3/B1-M3	18

**Pre-wired Models
(Shielded)**

Fig. 1 : E2EG-X1R5Cj /Bj

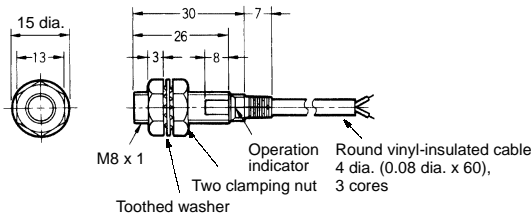

**Pre-wired Models
(Unshielded)**

Fig. 2 : E2EG-X2MCj /Bj

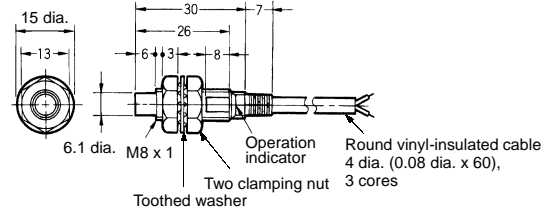

Fig. 3 : E2EG-X2Cj /Bj

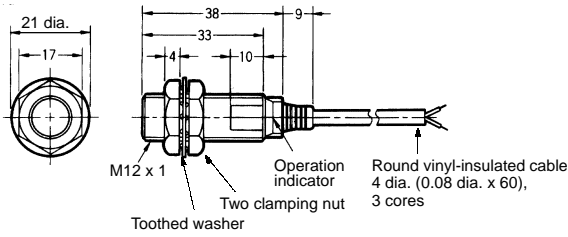

Fig. 4 : E2EG-X5MCj /Bj

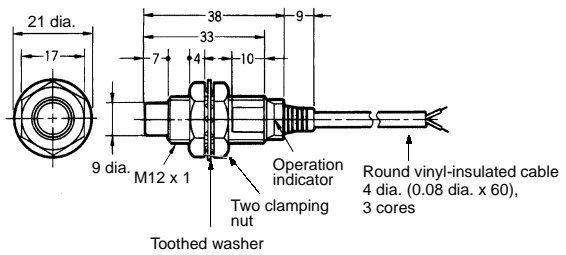

Fig. 5 : E2EG-X5Cj /Bj

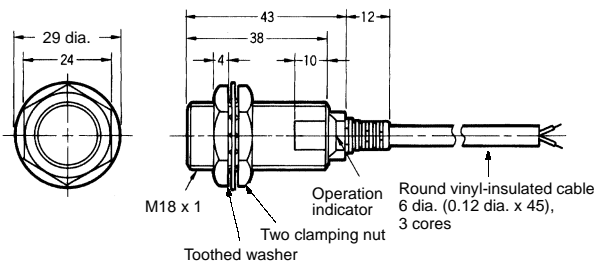

Fig. 6 : E2EG-X10MCj /Bj

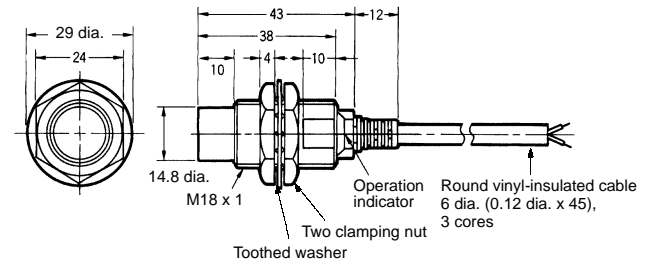

Fig. 7 : E2EG-X10Cj /Bj

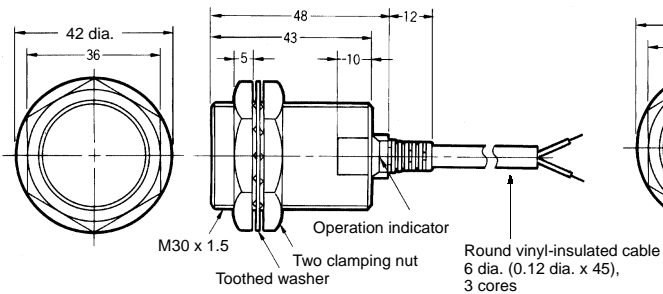
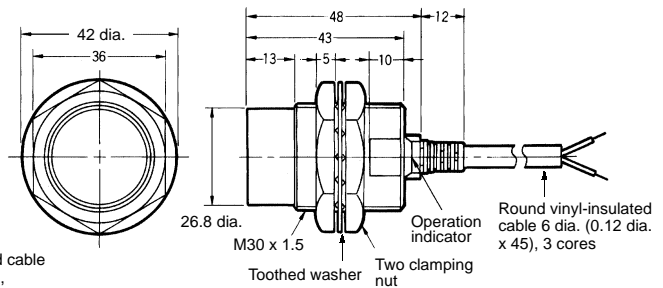

Fig. 8 : E2EG-X18MCj /Bj



**Connector Models
(Shielded)**

Fig. 9 : E2EG-X1R5Cj -M1/Bj -M1

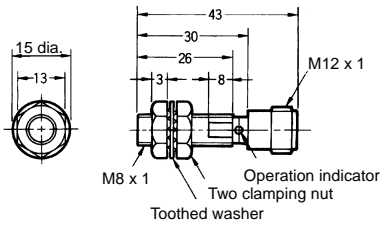

Fig. 11 : E2EG-X2Cj -M1/Bj -M1

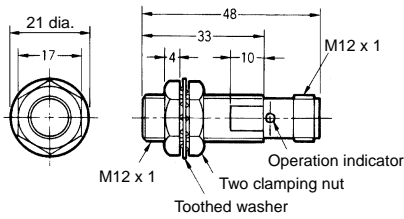

Fig. 13 : E2EG-X5Cj -M1/Bj -M1

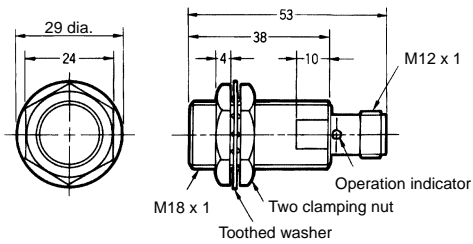
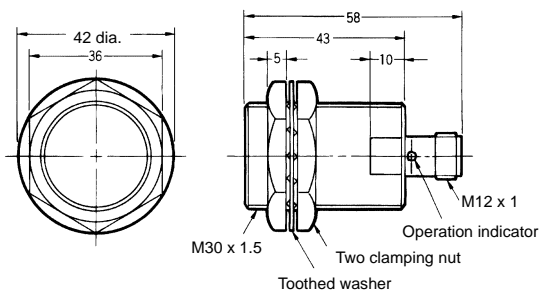

Fig. 15 : E2EG-X10Cj -M1/Bj -M1



**Connector Models
(Unshielded)**

Fig. 10 : E2EG-X2MCj -M1/Bj -M1

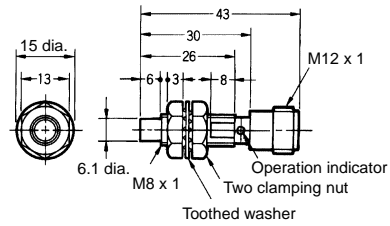

Fig. 12 : E2EG-X5MCj -M1/Bj -M1

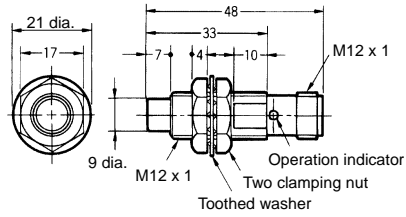

Fig. 14 : E2EG-X10MCj -M1/Bj -M1

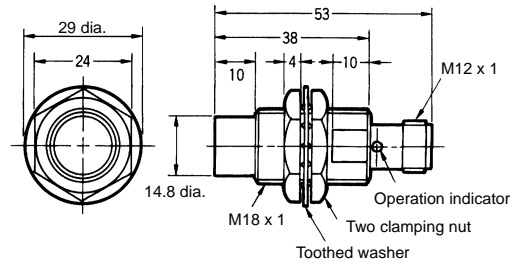
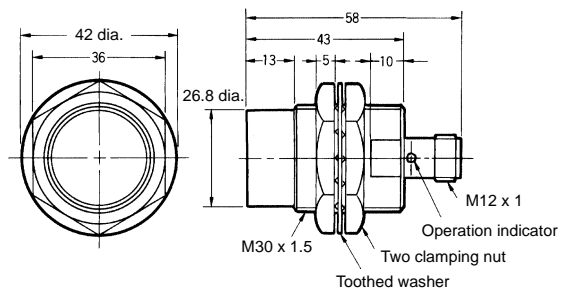
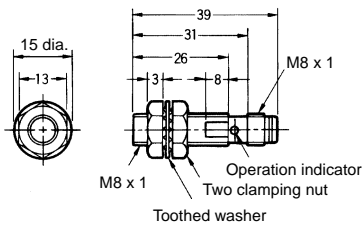

Fig. 16 : E2EG-X18MCj -M1/Bj -M1



**M8 Connector Models
(Shielded)**

Fig. 17 : E2EG-X1R5C1-M3/B1-M3



**M8 Connector Models
(Unshielded)**

Fig. 18 : E2EG-X2MC1-M3/B1-M3

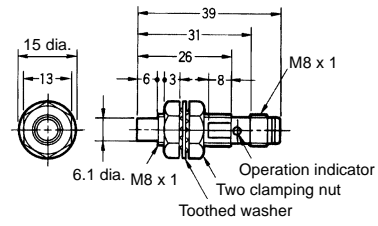

Mounting Holes

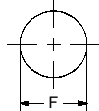

Dimensions	4 dia.	M5	5.4 dia.	M8	M12	M18	M30
F (mm)	4.2 ^{+0.5/0} dia.	5.5 ^{+0.5/0} dia.	5.7 ^{+0.5/0} dia.	8.5 ^{+0.5/0} dia.	12.5 ^{+0.5/0} dia.	18.5 ^{+0.5/0} dia.	30.5 ^{+0.5/0} dia.

Installation

■ Connection

E2EG-Xj Cj
DC 3-wire Models

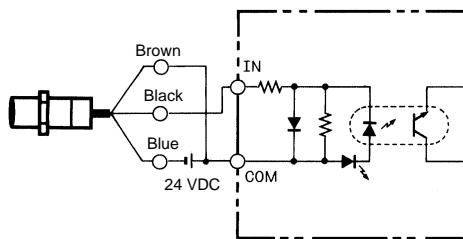

■ Pin Arrangement

E2EG-Xj Cj /Bj -M1/M3

Connector	Output configuration	Applicable models	Pin arrangement
M12	NO	E2EG-Xj C1-M1	<p>Note: Terminal 2 is not used.</p>
		E2EG-Xj B1-M1	<p>Note: Terminal 2 is not used.</p>
	NC	E2EG-Xj C2-M1	<p>Note: Terminal 4 is not used.</p>
		E2EG-Xj B2-M1	<p>Note: Terminal 4 is not used.</p>
M8	NO	E2EG-Xj C1-M3	<p>Note: Terminal 2 is not used.</p>
		E2EG-Xj B1-M3	<p>Note: Terminal 2 is not used.</p>

Precautions

Mounting

Do not tighten the nut with excessive force. A washer must be used with the nut.

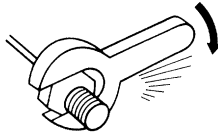

Note: The table below shows the tightening torques for part A and part B nuts. In the previous examples, the nut is on the sensor head side (part B) and hence the tightening torque for part B applies. If this nut is in part A, the tightening torque for part A applies instead.

Type		Part A		Part B
		Length	Torque	Torque
M8	Shielded	9 mm	9 N S m (91 kgf S cm)	12 N S m (120 kgf S cm)
	Unshielded	3 mm		
M12		30 N S m (310 kgf S cm)		
M18		70 N S m (710 kgf S cm)		
M30		180 N S m (1,800 kgf S cm)		

E2EG

Shielded Model

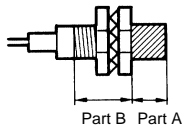

Unshielded Model

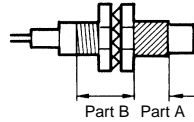

Effects of Surrounding Metal

When mounting the E2EG within a metal panel, ensure that the clearances given in the following table are maintained. Failure to maintain these distances may cause deterioration in the performance of the sensor.

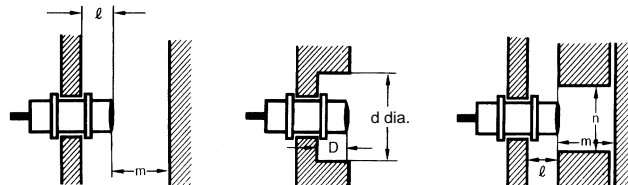

E2EG

Type		Item	M8	M12	M18	M30
E2EG-Xj Cj E2EG-Xj Bj DC 3-wire	Shielded	ℓ	0 mm	0 mm	0 mm	0 mm
		d	8 mm	12 mm	18 mm	30 mm
		D	0 mm	0 mm	0 mm	0 mm
		m	4.5 mm	8 mm	20 mm	40 mm
		n	12 mm	18 mm	27 mm	45 mm
	Unshielded	ℓ	6 mm	15 mm	22 mm	30 mm
		d	24 mm	40 mm	55 mm	90 mm
		D	6 mm	15 mm	22 mm	30 mm
		m	8 mm	20 mm	40 mm	70 mm
		n	24 mm	36 mm	54 mm	90 mm

Relationship between Screw Sizes and Models

E2EG

Type		Part number
M8	Shielded	E2EG-X1R5Cj /Bj
	Unshielded	E2EG-X2MCj /Bj
M12	Shielded	E2EG-X2Cj /Bj
	Unshielded	E2EG-X5MCj /Bj
M18	Shielded	E2EG-X5Cj /Bj
	Unshielded	E2EG-X10MCj /Bj
M30	Shielded	E2EG-X10Cj /Bj
	Unshielded	E2EG-X18MCj /Bj

Mutual Interference

When installing two or more Sensors face to face or side by side, ensure that the minimum distances given in the following table are maintained.

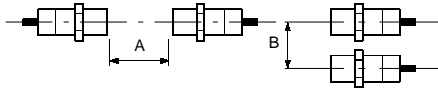

E2EG

Type		Item	M8	M12	M18	M30
E2EG-Xj Cj E2EG-Xj Bj DC 3-wire	Shielded	A	20 mm	30 mm	50 mm	100 mm
		B	15 mm	20 mm	35 mm	70 mm
	Unshielded	A	80 mm	120 mm	200 mm	300 mm
		B	60 mm	100 mm	110 mm	200 mm

Caution

Item	Examples
<p>Power supply</p> <p>Do not impose an excessive voltage on the E2EG, otherwise it may explode or burn. Do not impose 100 VAC on any E2EG DC model, otherwise it may explode or burn.</p>	
<p>Load short-circuit</p> <p>Do not short-circuit the load, or the E2EG may explode or burn. The E2EG's short-circuit protection function is valid if the polarity of the supply voltage imposed is correct and within the rated voltage range.</p>	
<p>Wiring</p> <p>Be sure to wire the E2EG and load correctly, otherwise it may explode or burn.</p>	
<p>Connection with no load</p> <p>Make sure to connect a proper load to the E2EG in operation, otherwise it may explode or burn.</p>	

Correct Use

Installation

Power Reset Time

The Proximity Sensor is ready to operate within 100 ms after power is supplied. If power supplies are connected to the Proximity Sensor and load respectively, be sure to supply power to the Proximity Sensor before supplying power to the load.

Power OFF

The Proximity Sensor may output a pulse signal when it is turned off. Therefore, it is recommended to turn off the load before turning off the Proximity Sensor.

Power Supply Transformer

When using a DC power supply, make sure that the DC power supply has an insulated transformer. Do not use a DC power supply with an auto-transformer.

Sensing Object

Metal Coating:
The sensing distances of the Proximity Sensor vary with the metal coating on sensing objects.

Wiring

High-tension Lines

Wiring through Metal Conduit

If there is a power or high-tension line near the cord of the Proximity

Sensor, wire the cord through an independent metal conduit to prevent against Proximity Sensor damage or malfunctioning.

Cord Tractive Force

Do not pull cords with the tractive forces exceeding the following.

Diameter	Tractive force
4 dia. max.	30 N max.
4 dia. min.	50 N max.

Mounting

The Proximity Sensor must not be subjected to excessive shock with a hammer when it is installed, otherwise the Proximity Sensor may be damaged or lose its water-resistivity.

Environment

Water Resistivity

Do not use the Proximity Sensor underwater, outdoors, or in the rain.

Operating Environment

Be sure to use the Proximity Sensor within its operating ambient temperature range and do not use the Proximity Sensor outdoors so that its reliability and life expectancy can be maintained. Although the Proximity Sensor is water resistive, a cover to protect the Proximity Sensor from water or water soluble machining oil is recommended so that its reliability and life expectancy can be maintained. Do not use the Proximity Sensor in an environment with chemical gas (e.g., strong alkaline or acid gasses including nitric, chromic, and concentrated sulfuric acid gases).

Connection type	Method	Description
AND (serial connection)	<p style="text-align: center;">Correct</p>	<p>The Sensors connected together must satisfy the following conditions.</p> <p>$i_L + (N - 1) \times i \leq$ Upper-limit of control output of each Sensor</p> <p>$V_S - N \times V_R \geq$ Load operating voltage</p> <p>N: No. of Sensors</p> <p>V_R: Residual voltage of each Sensor</p> <p>V_S: Supply voltage</p> <p>i: Current consumption of the Sensor</p> <p>i_L: Load current</p> <p>If the MY Relay, which operates at 24 VDC, is used as a load for example, a maximum of two Proximity Sensors can be connected to the load.</p>
OR (parallel connection)	<p style="text-align: center;">Correct</p>	<p>A minimum of three Sensors with current outputs can be connected in parallel. The number of Sensors connected in parallel varies with the Proximity Sensor model.</p>

ALL DIMENSIONS SHOWN ARE IN MILLIMETERS.

To convert millimeters into inches, multiply by 0.03937. To convert grams into ounces, multiply by 0.03527.

Cat. No. D060-E1-1 **In the interest of product improvement, specifications are subject to change without notice.**

OMRON Corporation

Systems Components Division H.Q.
28th Fl., Crystal Tower Bldg.
1-2-27, Shiromi, Chuo-ku,
Osaka 540 Japan
Phone: 06-949-6012 Fax: 06-949-6021

Printed in Japan
0796-2M (0796) a