

T-74-05-01

# ECG<sup>®</sup> Semiconductors

## ECG1211 POWER AMPLIFIER

**FEATURES:**

- High Gain
- High Output Power
- Built-in Short Circuit Protection
- Low Noise
- Low Distortion

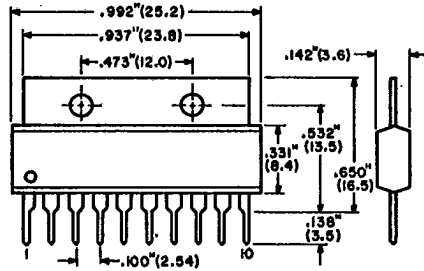

The ECG1211 is a monolithic integrated circuit for use as a 5.5 W AF power amplifier. It is designed for application in automotive sound systems and CB transceivers. It is typically operated at a supply voltage of 13.2 V with a 4 ohm load.

**MAXIMUM RATINGS ( $T_a = 25^\circ\text{C}$ )**

Characteristic	Symbol	Rating	Unit
Supply Voltage	$V_{CC}$ Max	18	V
Power Dissipation	$P_d$ Max	7*	W
Operating Temperature	$T_{opg}$	-20 to +75	$^\circ\text{C}$
Storage Temperature	$T_{stg}$	-40 to +150	$^\circ\text{C}$

\* 100 x 100 x 1.5 mm<sup>3</sup> Aluminum Heat Sink

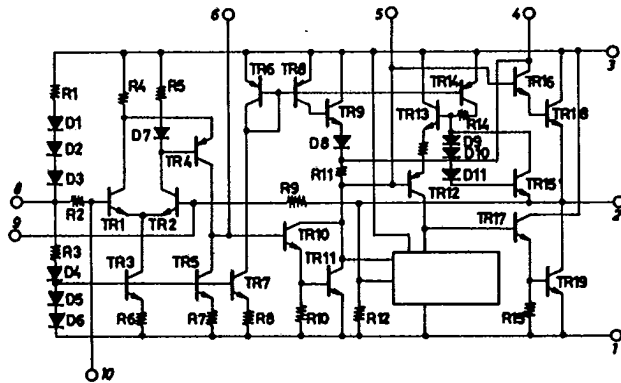
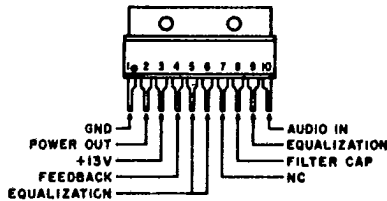

ELECTRICAL CHARACTERISTICS ( $T_a = 25^\circ\text{C}$ ,  $V_{cc} = 13.2\text{ V}$ ,  $R_L = 4\ \Omega$ )

T-74-05-01

Characteristic	Symbol	Conditions	Min.	Typ.	Max.	Unit
Operating Circuit Current	$I_{cc}$		--	50	100	mA
Voltage Gain	$V_G$	$R_{NF} = 62\ \Omega$	47	50	53	dB
Output Power	$P_o$	THD = 10%	4.5	5.5	--	W
Total Harmonic Distortion	THD	$P_o = 1\text{ W}$	--	0.3	1.0	%
Input Impedance	$r_i$		--	20	--	$\text{k}\Omega$
Noise Output Voltage	$V_{NO}$	$R_g = 10\ \text{k}\Omega$	--	0.6	3.0	mV

PIN NUMBERS

- 1 0 V
- 2 6.8 V
- 3 13.2 V
- 4 11.7 V
- 5 8.2 V
- 6 1.5 V
- 7 NC
- 8 6.8 V
- 9 6.8 V
- 10 6.8 V

TEST CIRCUIT

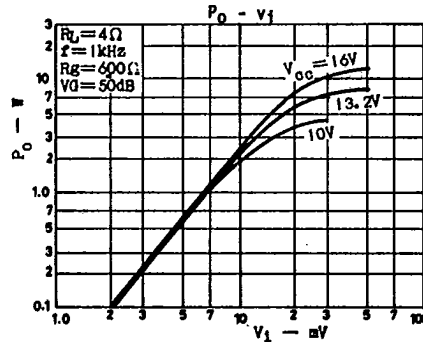
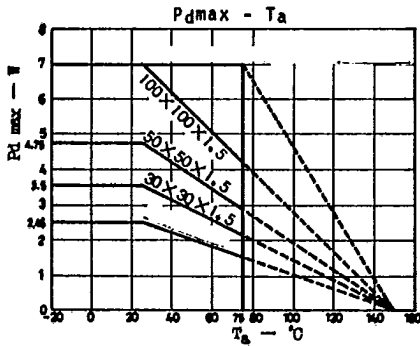
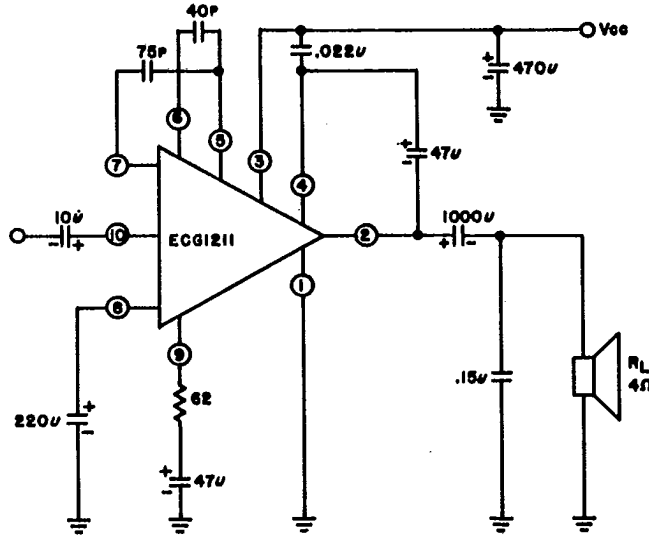

T-74-05-01

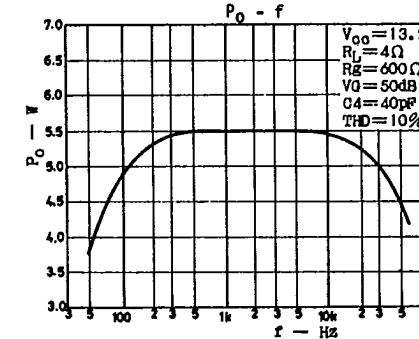
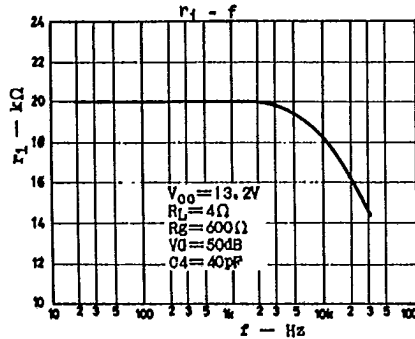
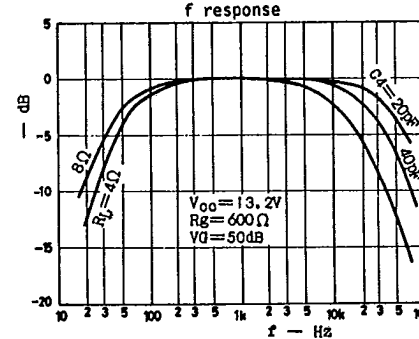
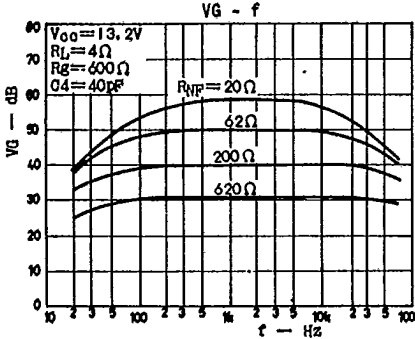
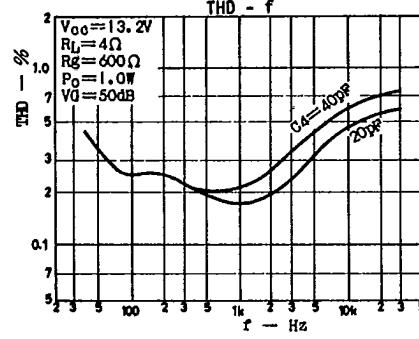
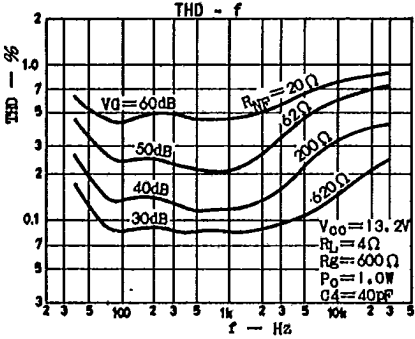
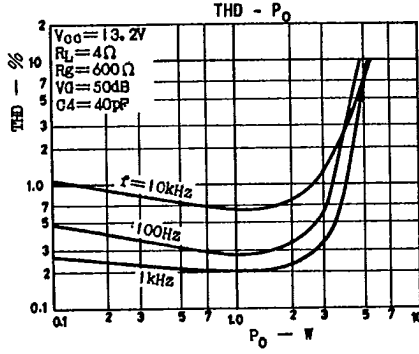
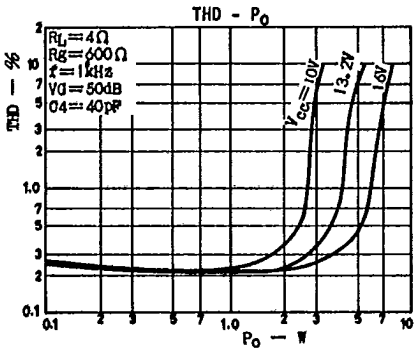

T-74-05-01

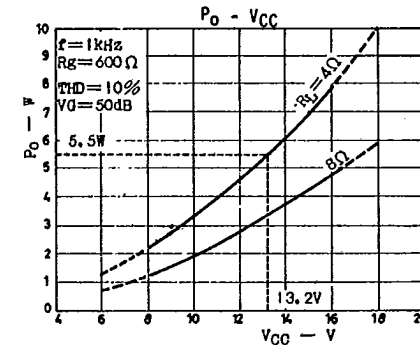
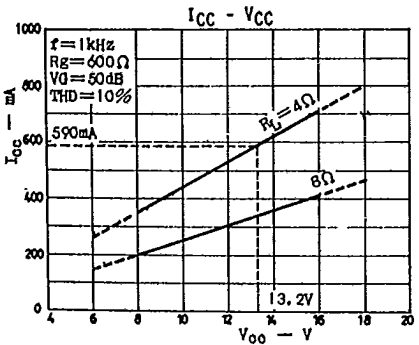
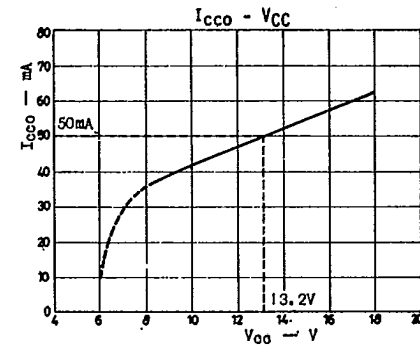
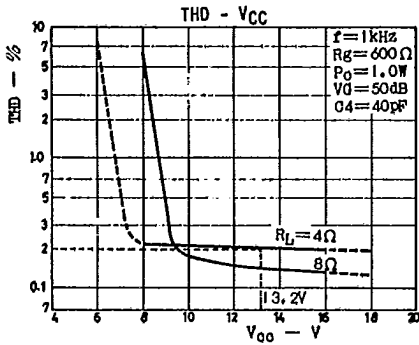
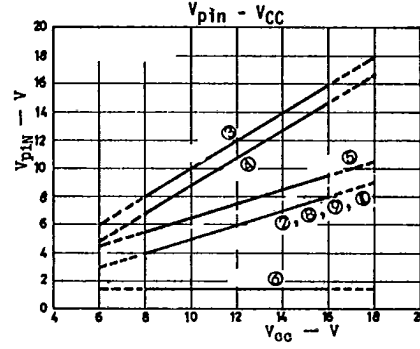
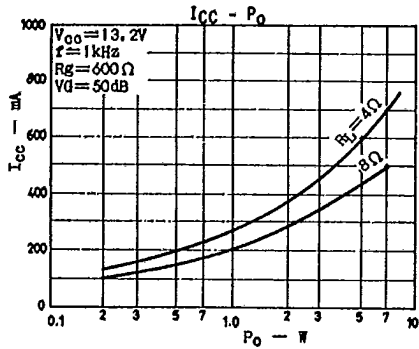
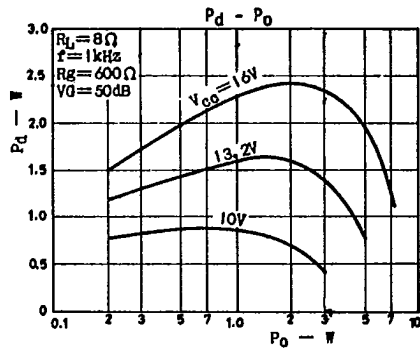
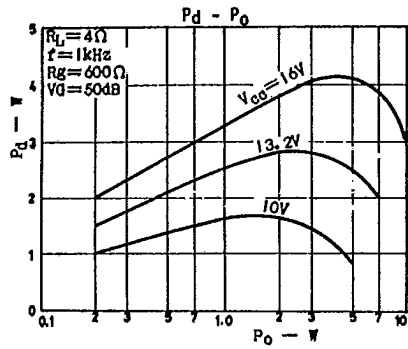

T-74-05-01

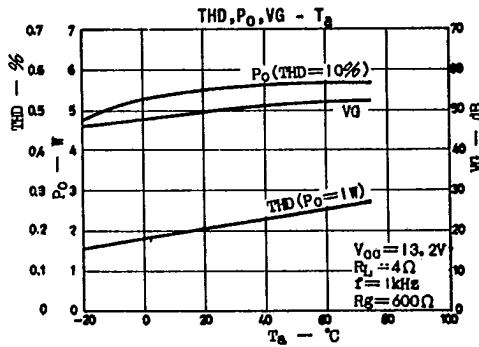
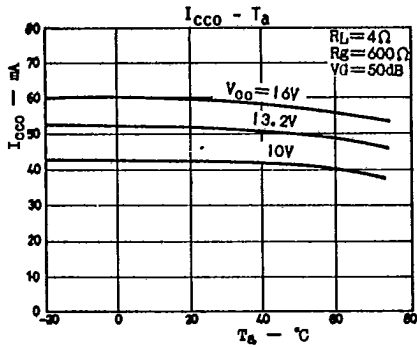
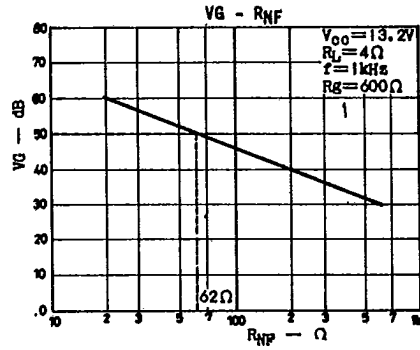
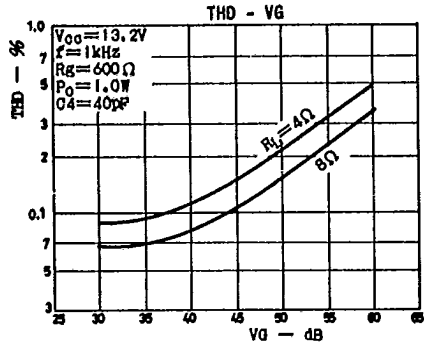
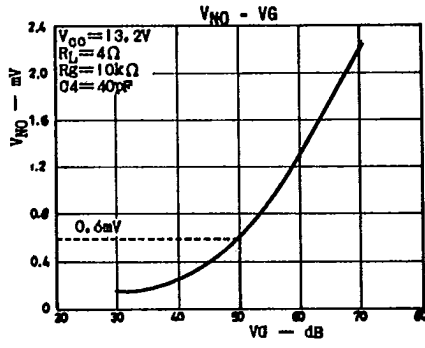
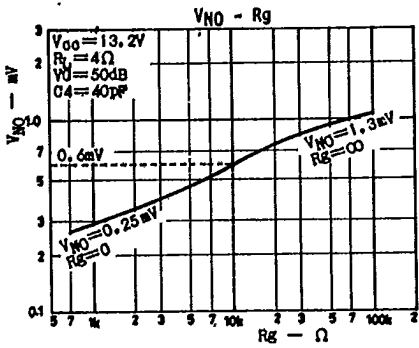

APPLICATIONS

T-74-05-01

