

## Optocoupler with Phototransistor Output

### Description

The CNY75(G) series consists of a phototransistor optically coupled to a gallium arsenide infrared-emitting diode in a 6-lead plastic dual inline package. The elements are mounted on one leadframe using a **coplanar technique**, providing a fixed distance between input and output for highest safety requirements.

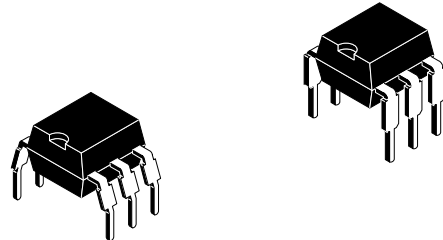

14827

### Applications

Circuits for safe protective separation against electrical shock according to safety class II (reinforced isolation):

- For appl. class I – IV at mains voltage  $\leq 300$  V
- For appl. class I – III at mains voltage  $\leq 600$  V according to VDE 0884, table 2, suitable for:

**Switch-mode power supplies, line receiver, computer peripheral interface, microprocessor system interface.**

### VDE Standards

These couplers perform safety functions according to the following equipment standards:

- **VDE 0884**  
Optocoupler for electrical safety requirements
- **IEC 950/EN 60950**  
Office machines (applied for reinforced isolation for mains voltage  $\leq 400$  V<sub>RMS</sub>)
- **VDE 0804**  
Telecommunication apparatus and data processing
- **IEC 65**  
Safety for mains-operated electronic and related household apparatus

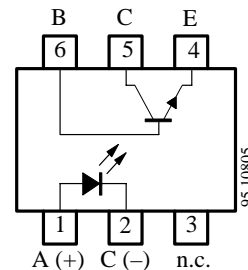

### Order Instruction

Ordering Code	CTR Ranking	Remarks
CNY75A/ CNY75GA <sup>1)</sup>	63 to 125%	
CNY75B/ CNY75GB <sup>1)</sup>	100 to 200%	
CNY75C/ CNY75GC <sup>1)</sup>	160 to 320%	
<sup>1)</sup> G = Leadform 10.16 mm; G is not market on the body		



### Features

#### Approvals:

- **BSI:** BS EN 41003, BS EN 60095 (BS 415), BS EN 60950 (BS 7002), Certificate number 7081 and 7402
- **FIMKO (SETI):** EN 60950, Certificate number 12399
- **Underwriters Laboratory (UL)** 1577 recognized, file number E-76222
- **VDE 0884**, Certificate number 94778

#### VDE 0884 related features:

- Rated impulse voltage (transient overvoltage)  $V_{IOTM} = 6$  kV peak
- Isolation test voltage (partial discharge test voltage)  $V_{pd} = 1.6$  kV
- Rated isolation voltage (RMS includes DC)  $V_{IOWM} = 600$   $V_{RMS}$  (848 V peak)

- Rated recurring peak voltage (repetitive)  $V_{IORM} = 600$   $V_{RMS}$
- Creepage current resistance according to VDE 0303/IEC 112  
**Comparative Tracking Index: CTI = 275**
- Thickness through insulation  $\geq 0.75$  mm

#### General features:

- Isolation materials according to UL94-VO
- Pollution degree 2 (DIN/VDE 0110 part 1 resp. IEC 664)
- Climatic classification 55/100/21 (IEC 68 part 1)
- Special construction: Therefore, extra low coupling capacity of typical 0.3 pF, high **Common Mode Rejection**
- Low temperature coefficient of CTR
- CTR offered in 3 groups
- Coupling System A

### Absolute Maximum Ratings

#### Input (Emitter)

Parameter	Test Conditions	Symbol	Value	Unit
Reverse voltage		$V_R$	5	V
Forward current		$I_F$	60	mA
Forward surge current	$t_p \leq 10 \mu s$	$I_{FSM}$	3	A
Power dissipation	$T_{amb} \leq 25^\circ C$	$P_V$	100	mW
Junction temperature		$T_j$	125	$^\circ C$

#### Output (Detector)

Parameter	Test Conditions	Symbol	Value	Unit
Collector base voltage		$V_{CBO}$	90	V
Collector emitter voltage		$V_{CEO}$	90	V
Emitter collector voltage		$V_{ECO}$	7	V
Collector current		$I_C$	50	mA
Collector peak current	$t_p/T = 0.5, t_p \leq 10$ ms	$I_{CM}$	100	mA
Power dissipation	$T_{amb} \leq 25^\circ C$	$P_V$	150	mW
Junction temperature		$T_j$	125	$^\circ C$

#### Coupler

Parameter	Test Conditions	Symbol	Value	Unit
AC isolation test voltage (RMS)	$t = 1$ min	$V_{IO}$	3.75	kV
Total power dissipation	$T_{amb} \leq 25^\circ C$	$P_{tot}$	250	mW
Ambient temperature range		$T_{amb}$	-55 to +100	$^\circ C$
Storage temperature range		$T_{stg}$	-55 to +125	$^\circ C$
Soldering temperature	2 mm from case, $t \leq 10$ s	$T_{sd}$	260	$^\circ C$



## Electrical Characteristics ( $T_{amb} = 25^{\circ}\text{C}$ )

### Input (Emitter)

Parameter	Test Conditions	Symbol	Min.	Typ.	Max.	Unit
Forward voltage	$I_F = 50 \text{ mA}$	$V_F$		1.25	1.6	V
Reverse current	$V_R = 6 \text{ V}$	$I_R$			10	$\mu\text{A}$
Junction capacitance	$V_R = 0, f = 1 \text{ MHz}$	$C_j$		50		pF

### Output (Detector)

Parameter	Test Conditions	Symbol	Min.	Typ.	Max.	Unit
Collector base voltage	$I_C = 100 \mu\text{A}$	$V_{CB0}$	90			V
Collector emitter voltage	$I_C = 1 \text{ mA}$	$V_{CEO}$	90			V
Emitter collector voltage	$I_E = 100 \mu\text{A}$	$V_{ECO}$	7			V
Collector emitter cut-off current	$V_{CE} = 20 \text{ V}, I_F = 0$	$I_{CEO}$			150	nA

### Coupler

Parameter	Test Conditions	Symbol	Min.	Typ.	Max.	Unit
Collector emitter saturation voltage	$I_F = 10 \text{ mA}, I_C = 1 \text{ mA}$	$V_{CEsat}$			0.3	V
Cut-off frequency	$V_{CE} = 5 \text{ V}, I_F = 10 \text{ mA}, R_L = 100 \Omega$	$f_c$		110		kHz
Coupling capacitance	$f = 1 \text{ MHz}$	$C_k$		0.3		pF

### Current Transfer Ratio (CTR)

Parameter	Test Conditions	Type	Symbol	Min.	Typ.	Max.	Unit
$I_C/I_F$	$V_{CE} = 5 \text{ V}, I_F = 1 \text{ mA}$	CNY75(G)A	CTR	0.15			
		CNY75(G)B	CTR	0.3			
		CNY75(G)C	CTR	0.6			
	$V_{CE} = 5 \text{ V}, I_F = 10 \text{ mA}$	CNY75(G)A	CTR	0.63		1.25	
		CNY75(G)B	CTR	1		2	
		CNY75(G)C	CTR	1.6		3.2	



### Maximum Safety Ratings (according to VDE 0884) see figure 1

This device is used for protective separation against electrical shock only within the maximum safety ratings. This must be ensured by using protective circuits in the applications.

#### Input (Emitter)

Parameters	Test Conditions	Symbol	Value	Unit
Forward current		$I_{si}$	130	mA

#### Output (Detector)

Parameters	Test Conditions	Symbol	Value	Unit
Power dissipation	$T_{amb} \leq 25^\circ\text{C}$	$P_{si}$	265	mW

#### Coupler

Parameters	Test Conditions	Symbol	Value	Unit
Rated impulse voltage		$V_{IOTM}$	6	kV
Safety temperature		$T_{si}$	150	$^\circ\text{C}$

### Insulation Rated Parameters (according to VDE 0884)

Parameter	Test Conditions	Symbol	Min.	Typ.	Max.	Unit
Partial discharge test voltage – Routine test	100%, $t_{test} = 1\text{ s}$	$V_{pd}$	1.6			kV
Partial discharge test voltage – Lot test (sample test)	$t_{Tr} = 60\text{ s}$ , $t_{test} = 10\text{ s}$ , (see figure 2)	$V_{IOTM}$	6			kV
		$V_{pd}$	1.3			kV
Insulation resistance	$V_{IO} = 500\text{ V}$	$R_{IO}$	$10^{12}$			$\Omega$
	$V_{IO} = 500\text{ V}$ , $T_{amb} \leq 100^\circ\text{C}$	$R_{IO}$	$10^{11}$			$\Omega$
	$V_{IO} = 500\text{ V}$ , $T_{amb} \leq 150^\circ\text{C}$ (construction test only)	$R_{IO}$	$10^9$			$\Omega$

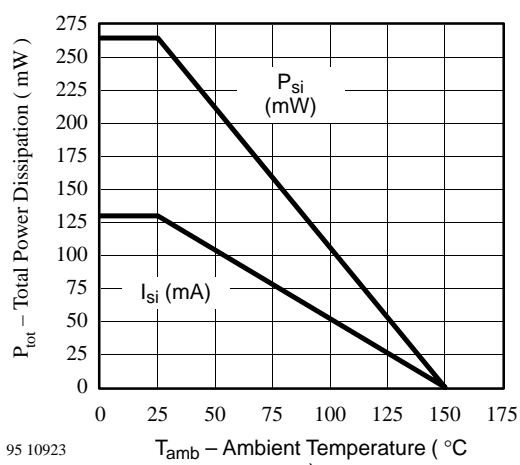

Figure 1. Derating diagram

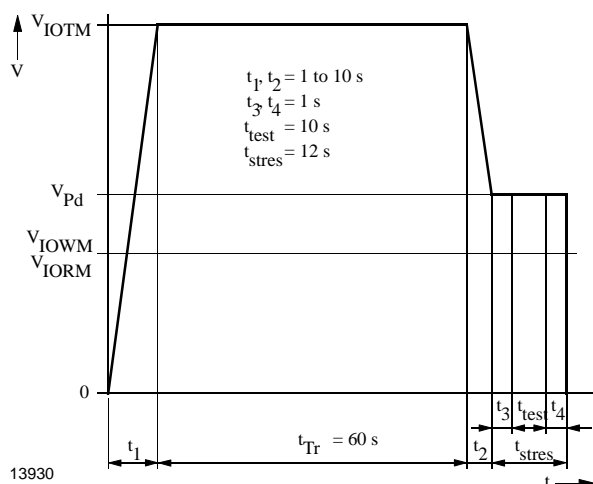

Figure 2. Test pulse diagram for sample test according to DIN VDE 0884

**Switching Characteristics of CNY75(G)A**

Parameter	Test Conditions	Symbol	Typ.	Unit
Delay time	$V_S = 5\text{ V}$ , $I_C = 10\text{ mA}$ , $R_L = 100\ \Omega$ (see figure 3)	$t_d$	2.0	$\mu\text{s}$
Rise time		$t_r$	2.5	$\mu\text{s}$
Fall time		$t_f$	2.7	$\mu\text{s}$
Storage time		$t_s$	0.3	$\mu\text{s}$
Turn-on time		$t_{on}$	4.5	$\mu\text{s}$
Turn-off time		$t_{off}$	3.0	$\mu\text{s}$
Turn-on time	$V_S = 5\text{ V}$ , $I_F = 10\text{ mA}$ , $R_L = 1\text{ k}\Omega$ (see figure 4)	$t_{on}$	10.0	$\mu\text{s}$
Turn-off time		$t_{off}$	25.0	$\mu\text{s}$

**Switching Characteristics of CNY75(G)B**

Parameter	Test Conditions	Symbol	Typ.	Unit
Delay time	$V_S = 5\text{ V}$ , $I_C = 10\text{ mA}$ , $R_L = 100\ \Omega$ (see figure 3)	$t_d$	2.5	$\mu\text{s}$
Rise time		$t_r$	3.0	$\mu\text{s}$
Fall time		$t_f$	3.7	$\mu\text{s}$
Storage time		$t_s$	0.3	$\mu\text{s}$
Turn-on time		$t_{on}$	5.5	$\mu\text{s}$
Turn-off time		$t_{off}$	4.0	$\mu\text{s}$
Turn-on time	$V_S = 5\text{ V}$ , $I_F = 10\text{ mA}$ , $R_L = 1\text{ k}\Omega$ (see figure 4)	$t_{on}$	16.5	$\mu\text{s}$
Turn-off time		$t_{off}$	20	$\mu\text{s}$

**Switching Characteristics of CNY75(G)C**

Parameter	Test Conditions	Symbol	Typ.	Unit
Delay time	$V_S = 5\text{ V}$ , $I_C = 10\text{ mA}$ , $R_L = 100\ \Omega$ (see figure 3)	$t_d$	2.8	$\mu\text{s}$
Rise time		$t_r$	4.2	$\mu\text{s}$
Fall time		$t_f$	4.7	$\mu\text{s}$
Storage time		$t_s$	0.3	$\mu\text{s}$
Turn-on time		$t_{on}$	7.0	$\mu\text{s}$
Turn-off time		$t_{off}$	5.0	$\mu\text{s}$
Turn-on time	$V_S = 5\text{ V}$ , $I_F = 10\text{ mA}$ , $R_L = 1\text{ k}\Omega$ (see figure 4)	$t_{on}$	11	$\mu\text{s}$
Turn-off time		$t_{off}$	37.5	$\mu\text{s}$

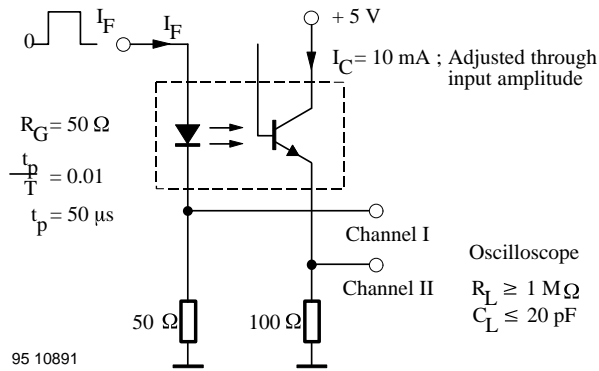

Figure 3. Test circuit, non-saturated operation

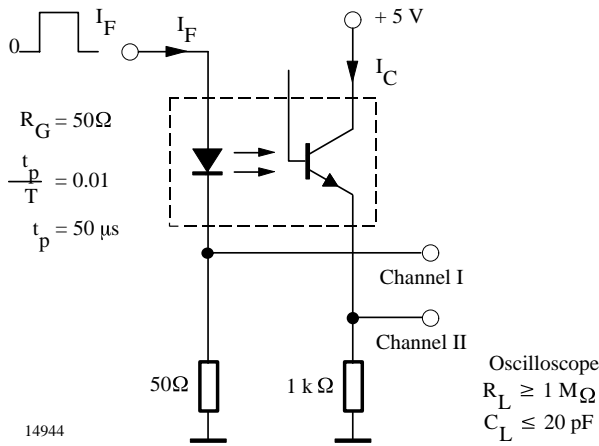

Figure 4. Test circuit, saturated operation

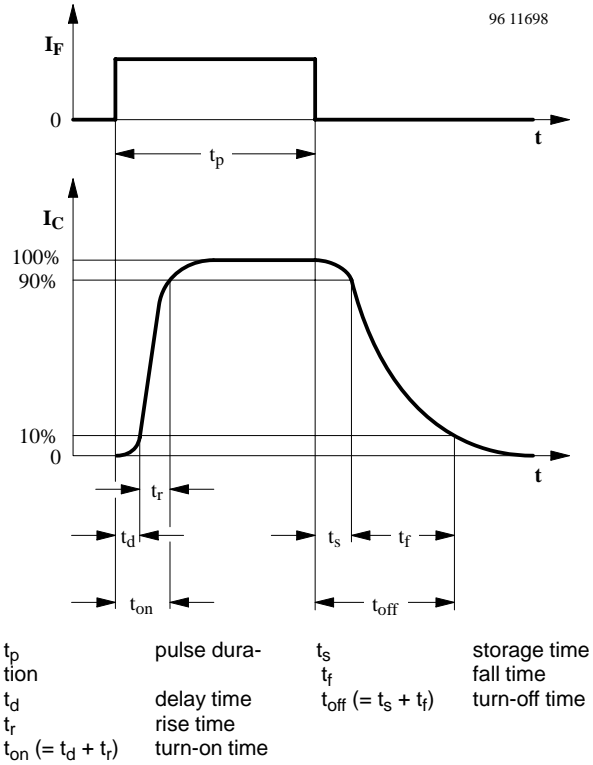

Figure 5. Switching times

### Typical Characteristics ( $T_{amb} = 25^\circ\text{C}$ , unless otherwise specified)

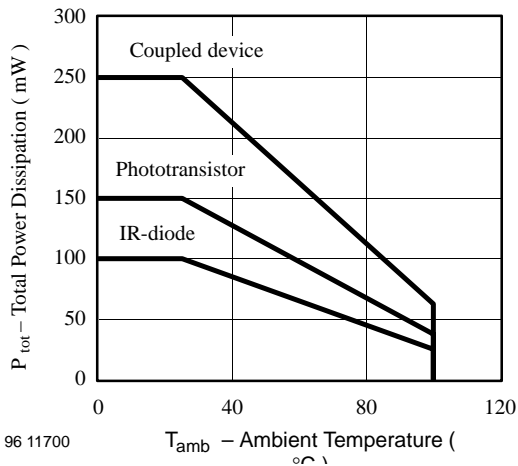

Figure 6. Total Power Dissipation vs. Ambient Temperature

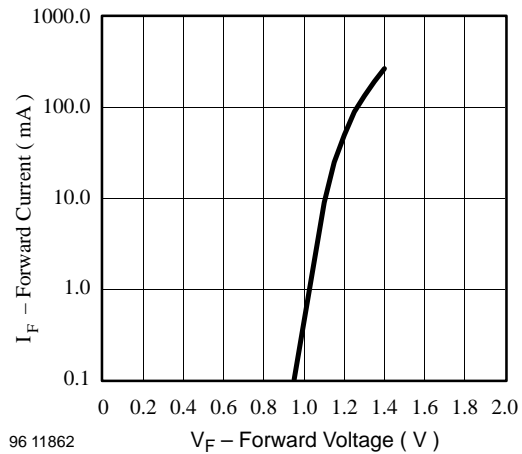
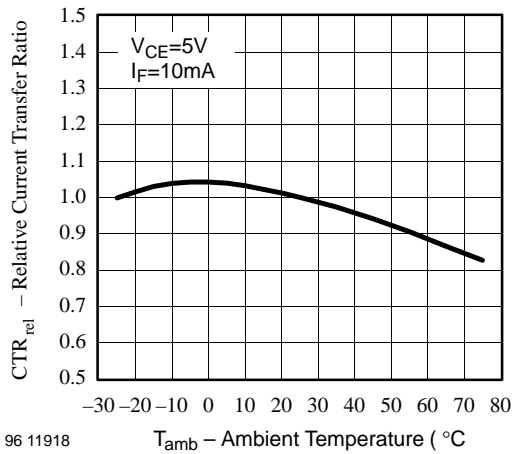
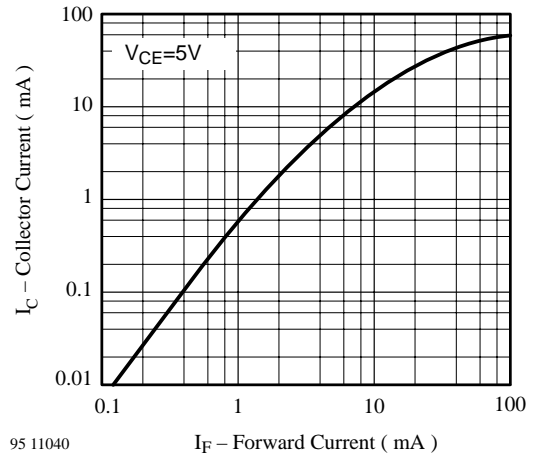

Figure 7. Forward Current vs. Forward Voltage



96 11918  
Figure 8. Relative Current Transfer Ratio vs. Ambient Temperature



95 11040  
Figure 11. Collector Current vs. Forward Current

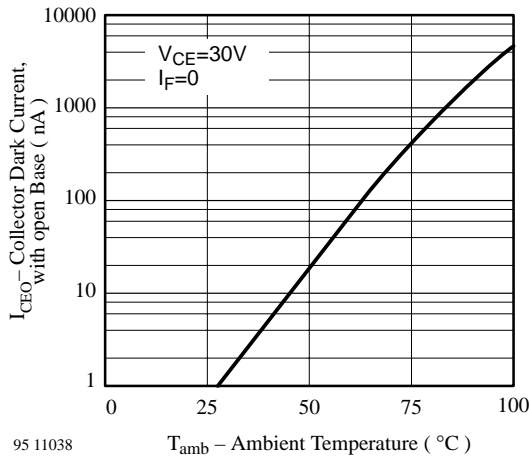

95 11038  
Figure 9. Collector Dark Current vs. Ambient Temperature

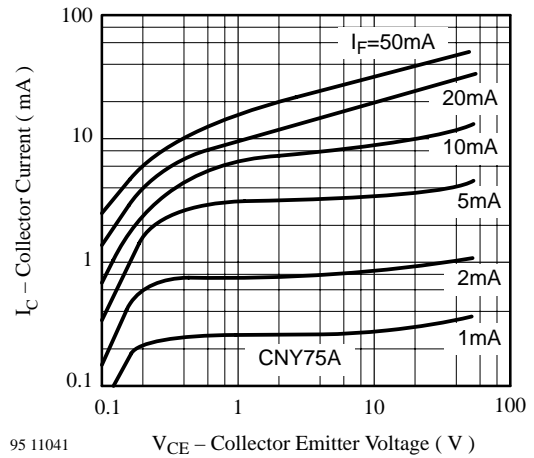

95 11041  
Figure 12. Collector Current vs. Collector Emitter Voltage

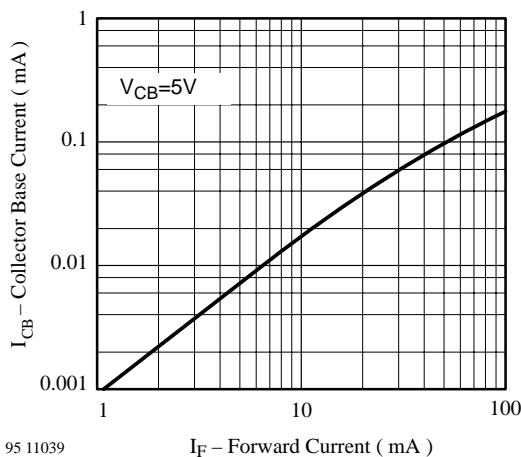

95 11039  
Figure 10. Collector Base Current vs. Forward Current

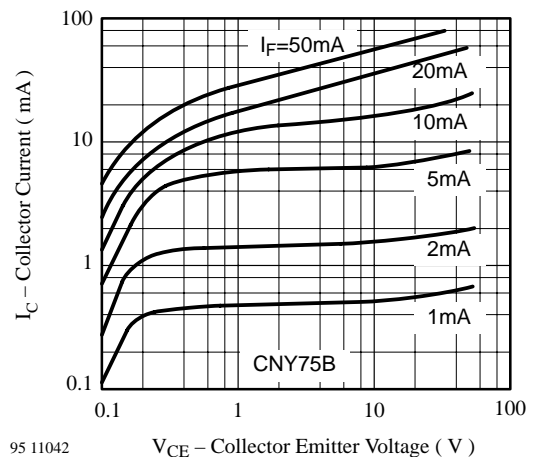

95 11042  
Figure 13. Collector Current vs. Collector Emitter Voltage

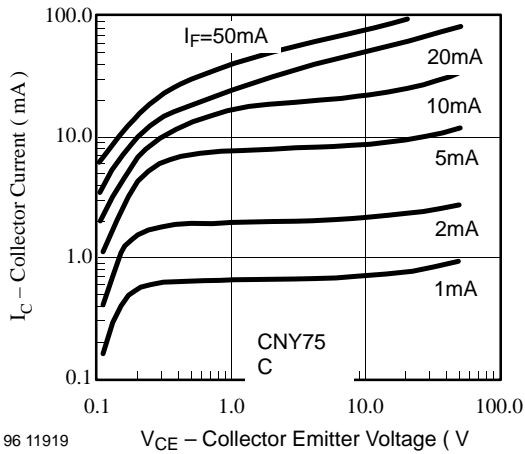

Figure 14. Collector Current vs. Collector Emitter Voltage

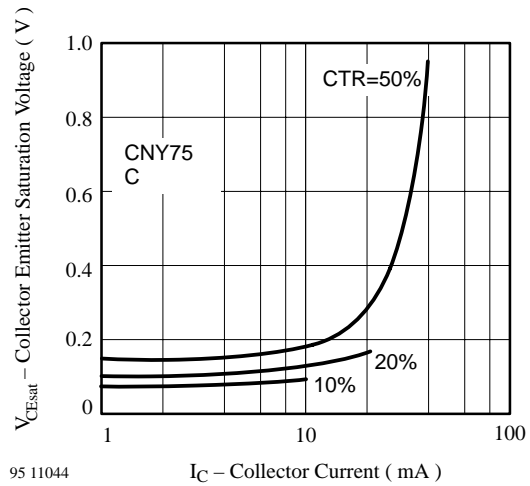

Figure 17. Coll. Emitter Sat. Voltage vs. Coll. Current

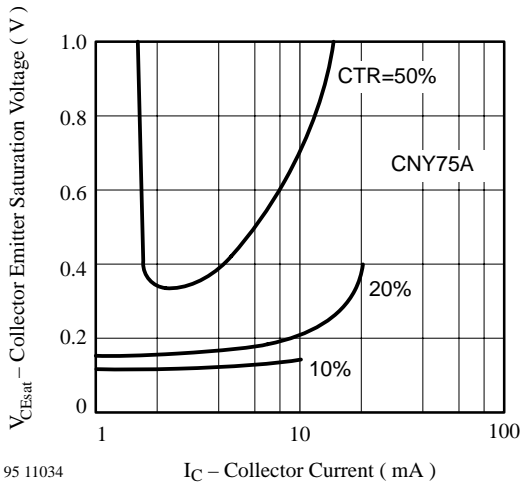

Figure 15. Coll. Emitter Sat. Voltage vs. Coll. Current

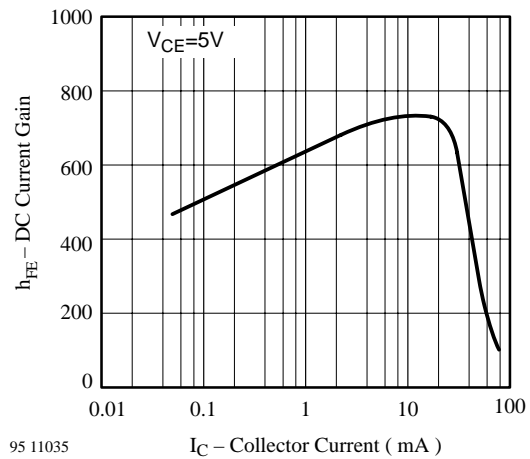

Figure 18. DC Current Gain vs. Collector Current

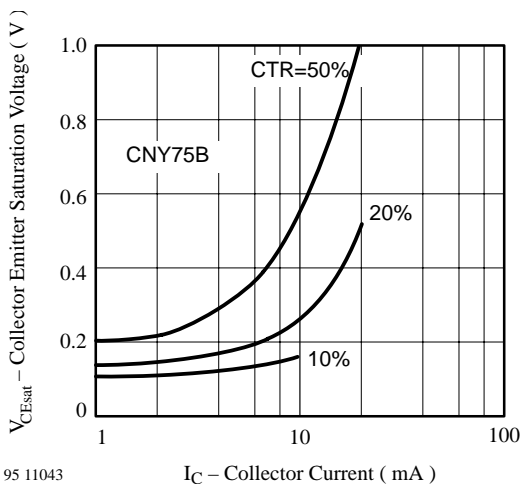

Figure 16. Coll. Emitter Sat. Voltage vs. Coll. Current

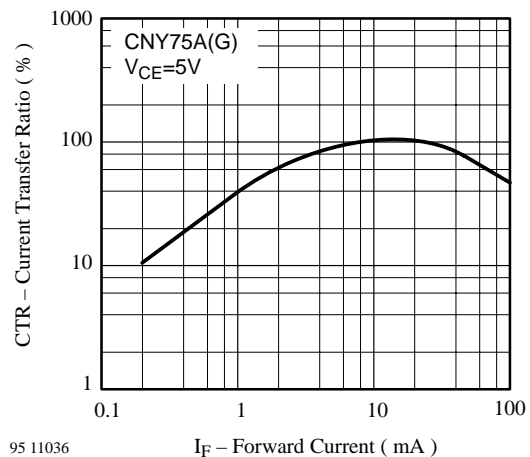

Figure 19. Current Transfer Ratio vs. Forward Current



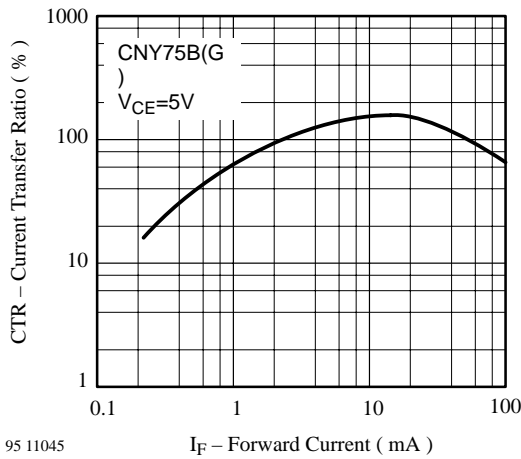

Figure 20. Current Transfer Ratio vs. Forward Current

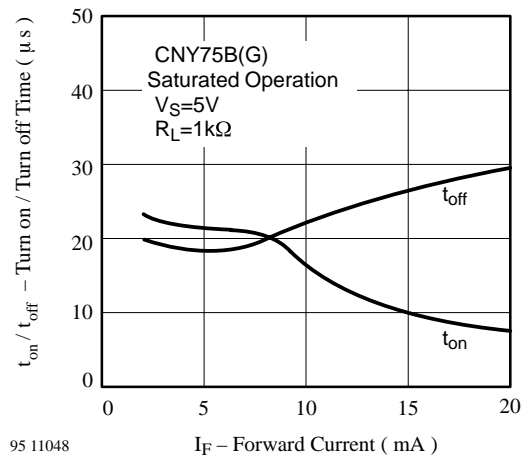

Figure 23. Turn on / off Time vs. Forward Current

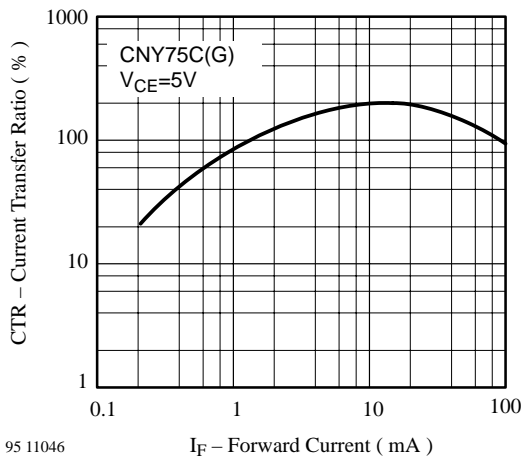

Figure 21. Current Transfer Ratio vs. Forward Current

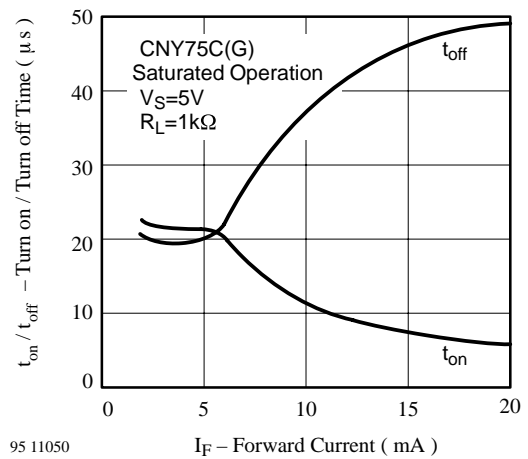

Figure 24. Turn on / off Time vs. Forward Current

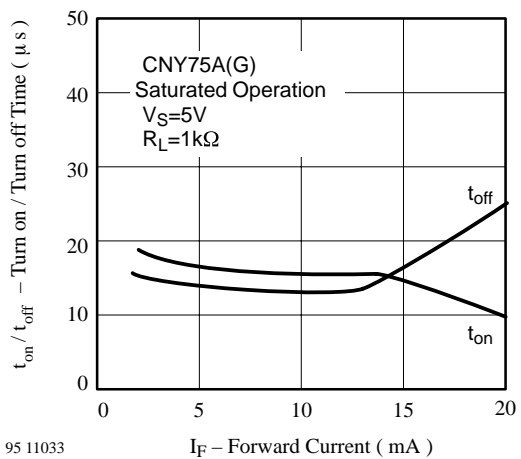

Figure 22. Turn on / off Time vs. Forward Current

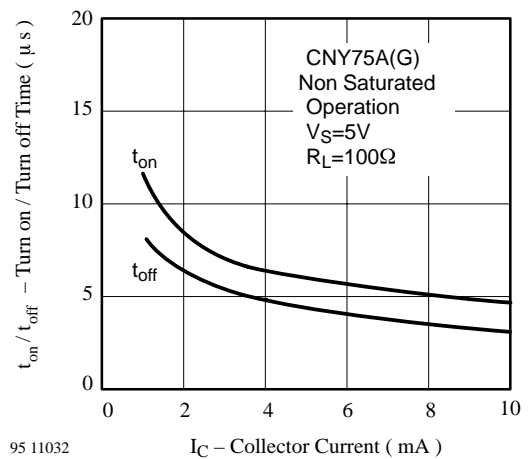
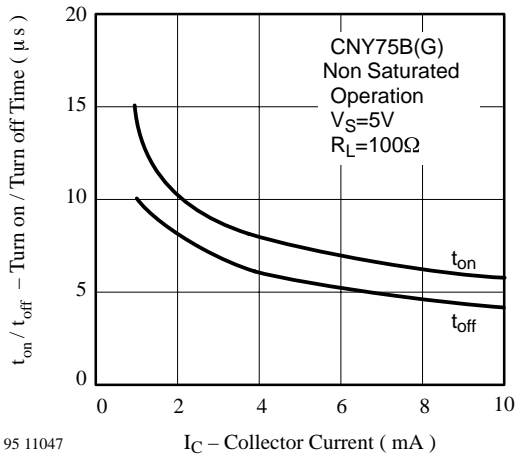
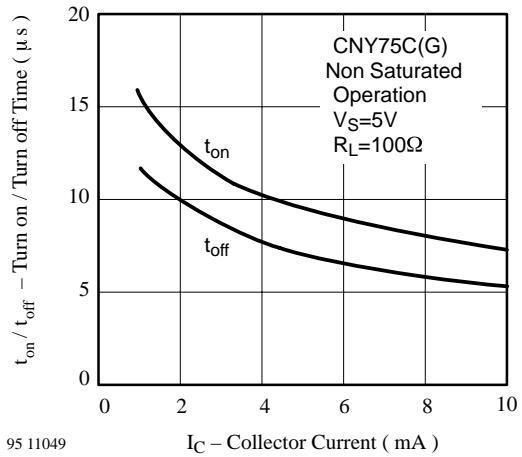

Figure 25. Turn on / off Time vs. Collector Current



95 11047

Figure 26. Turn on / off Time vs. Collector Current



95 11049

Figure 27. Turn on / off Time vs. Collector Current

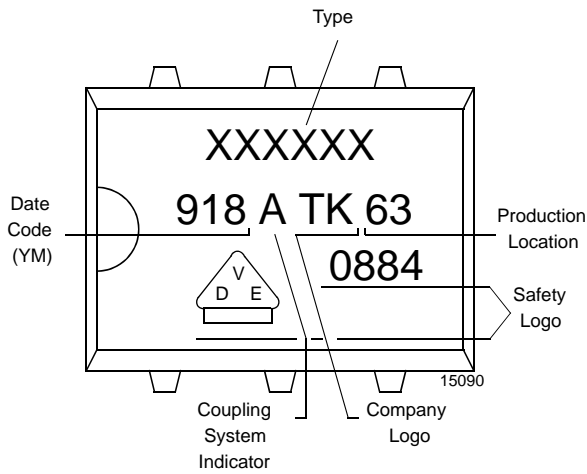
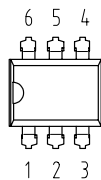
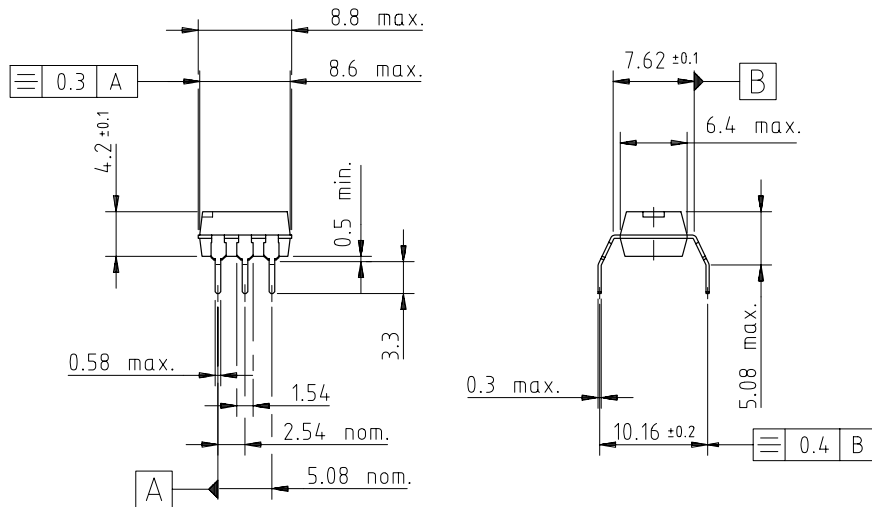

Figure 28. Marking example

## Dimensions of CNY75G in mm



weight: ca. 0.50 g  
 creepage distance:  $\cong$  8 mm  
 air path:  $\cong$  8 mm

after mounting on PC board

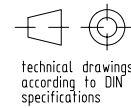

14771

## Dimensions of CNY75 in mm

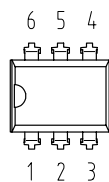
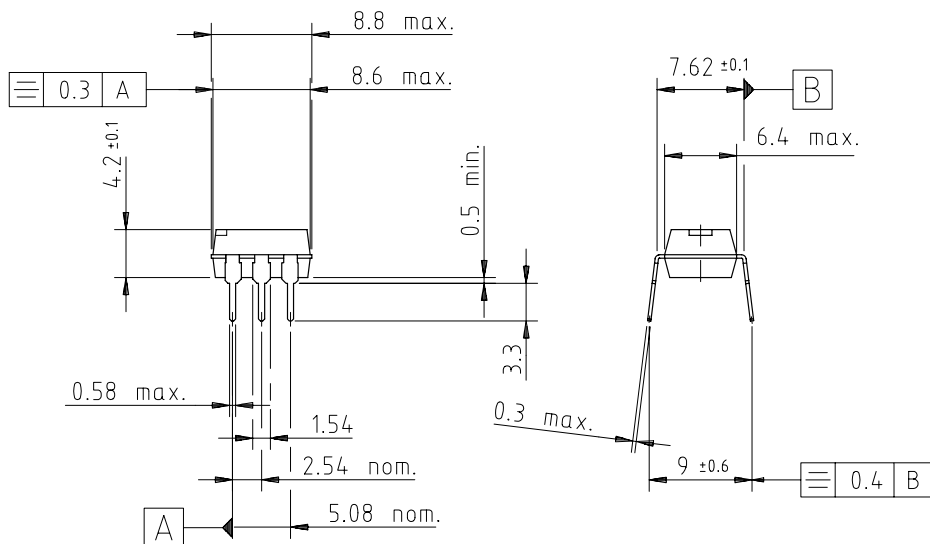

weight: 0.50 g  
 creepage distance:  $\cong$  6 mm  
 air path:  $\cong$  6 mm

after mounting on PC board

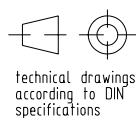

14770