

NPN 5 GHz wideband transistor



BFR96S

N AMER PHILIPS/DISCRETE

69E D

DESCRIPTION

NPN transistor in a plastic SOT37 envelope primarily intended for MATV applications. The device features excellent output voltage capabilities.

PNP complement is the BFQ32S.

PINNING

PIN	DESCRIPTION
Code: BFR96S/02	
1	base
2	emitter
3	collector

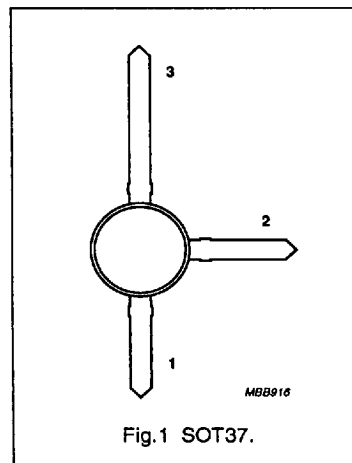

QUICK REFERENCE DATA

SYMBOL	PARAMETER	CONDITIONS	TYP.	MAX.	UNIT
V_{CBO}	collector-base voltage	open emitter	–	20	V
V_{CEO}	collector-emitter voltage	open base	–	15	V
I_C	DC collector current		–	100	mA
P_{tot}	total power dissipation	up to $T_s = 143\text{ °C}$ (note 1)	–	700	mW
f_T	transition frequency	$I_C = 70\text{ mA}$; $V_{CE} = 10\text{ V}$; $f = 500\text{ MHz}$; $T_i = 25\text{ °C}$	5	–	GHz
C_{re}	feedback capacitance	$I_C = 0$; $V_{CE} = 10\text{ V}$; $f = 1\text{ MHz}$	1	–	pF
G_{UM}	maximum unilateral power gain	$I_C = 70\text{ mA}$; $V_{CE} = 10\text{ V}$; $f = 800\text{ MHz}$; $T_{amb} = 25\text{ °C}$	11.5	–	dB
F	noise figure	$I_C = 70\text{ mA}$; $V_{CE} = 10\text{ V}$; $f = 800\text{ MHz}$; $T_{amb} = 25\text{ °C}$	4	–	dB
V_O	output voltage	$d_m = -60\text{ dB}$; $I_C = 70\text{ mA}$; $V_{CE} = 10\text{ V}$; $R_L = 75\text{ }\Omega$; $T_{amb} = 25\text{ °C}$ $f_{(p+q-r)} = 793.25\text{ MHz}$	700	–	mV
P_{L1}	output power at 1 dB gain compression	$I_C = 70\text{ mA}$; $V_{CE} = 10\text{ V}$; $R_L = 75\text{ }\Omega$; $T_{amb} = 25\text{ °C}$; measured at $f = 800\text{ MHz}$	21	–	dBm
ITO	third order intercept point	$I_C = 70\text{ mA}$; $V_{CE} = 10\text{ V}$; $R_L = 75\text{ }\Omega$; $T_{amb} = 25\text{ °C}$	40	–	dBm

Note

1. T_s is the temperature at the soldering point of the collector lead.

NPN 5 GHz wideband transistor

BFR96S

N AMER PHILIPS/DISCRETE

69E D

LIMITING VALUES

In accordance with the Absolute Maximum System (IEC 134).

SYMBOL	PARAMETER	CONDITIONS	MIN.	MAX.	UNIT
V_{CBO}	collector-base voltage	open emitter	-	20	V
V_{CEO}	collector-emitter voltage	open base	-	15	V
V_{EBO}	emitter-base voltage	open collector	-	3	V
I_C	DC collector current		-	100	mA
P_{tot}	total power dissipation	up to $T_s = 143\text{ °C}$ (note 1)	-	700	mW
T_{stg}	storage temperature		-65	150	°C
T_j	junction temperature		-	175	°C

THERMAL RESISTANCE

SYMBOL	PARAMETER	CONDITIONS	THERMAL RESISTANCE
$R_{th(j-s)}$	thermal resistance from junction to soldering point	up to $T_s = 143\text{ °C}$ (note 1)	45 K/W

Note

- T_s is the temperature at the soldering point of the collector lead.

NPN 5 GHz wideband transistor

BFR96S

N AMER PHILIPS/DISCRETE

69E D

CHARACTERISTICS

 $T_j = 25\text{ }^\circ\text{C}$ unless otherwise specified.

SYMBOL	PARAMETER	CONDITIONS	MIN.	TYP.	MAX.	UNIT
I_{CBO}	collector cut-off current	$I_E = 0; V_{CB} = 10\text{ V}$	—	—	100	nA
h_{FE}	DC current gain	$I_C = 70\text{ mA}; V_{CE} = 10\text{ V}$	25	80	—	
f_T	transition frequency	$I_C = 70\text{ mA}; V_{CE} = 10\text{ V}; f = 500\text{ MHz}$	—	5	—	GHz
C_c	collector capacitance	$I_E = I_B = 0; V_{CB} = 10\text{ V}; f = 1\text{ MHz}$	—	1.5	—	pF
C_e	emitter capacitance	$I_C = I_C = 0; V_{EB} = 0.5\text{ V}; f = 1\text{ MHz}$	—	6.5	—	pF
C_{re}	feedback capacitance	$I_C = 0; V_{CE} = 10\text{ V}; f = 1\text{ MHz}$	—	1	—	pF
G_{UM}	maximum unilateral power gain (note 1)	$I_C = 70\text{ mA}; V_{CE} = 10\text{ V};$ $f = 800\text{ MHz}; T_{amb} = 25\text{ }^\circ\text{C}$	—	11.5	—	dB
F	noise figure	$I_C = 70\text{ mA}; V_{CE} = 10\text{ V};$ $f = 800\text{ MHz}; T_{amb} = 25\text{ }^\circ\text{C}$	—	4	—	dB
d_2	second order intermodulation distortion	note 2	—	-52	—	dB
V_O	output voltage	note 3	—	700	—	mV
P_{L1}	output power at 1 dB gain compression	$I_C = 70\text{ mA}; V_{CE} = 10\text{ V}; R_L = 75\text{ }^\Omega;$ $T_{amb} = 25\text{ }^\circ\text{C};$ measured at $f = 800\text{ MHz}$	—	21	—	dBm
ITO	third order intercept point	note 4	—	40	—	dBm

Notes

- G_{UM} is the maximum unilateral power gain, assuming S_{12} is zero and $G_{UM} = 10 \log \frac{|S_{21}|^2}{(1 - |S_{11}|^2)(1 - |S_{22}|^2)}$ dB.
- $I_C = 70\text{ mA}; V_{CE} = 10\text{ V}; R_L = 75\text{ }^\Omega; T_{amb} = 25\text{ }^\circ\text{C};$
 $V_p = V_O = 316\text{ mV} = 50\text{ dBmV}; f_p = 250\text{ MHz};$
 $V_q = V_O = 316\text{ mV} = 50\text{ dBmV}; f_q = 560\text{ MHz};$
measured at $f_{(p+q)} = 810\text{ MHz}.$
- $d_{im} = -60\text{ dB}$ (DIN 45004B); $I_C = 70\text{ mA}; V_{CE} = 10\text{ V}; R_L = 75\text{ }^\Omega; T_{amb} = 25\text{ }^\circ\text{C};$
 $V_p = V_O$ at $d_{im} = -60\text{ dB}; f_p = 795.25\text{ MHz};$
 $V_q = V_O - 6\text{ dB}; f_q = 803.25\text{ MHz};$
 $V_r = V_O - 6\text{ dB}; f_r = 805.25\text{ MHz};$
measured at $f_{(p+q-r)} = 793.25\text{ MHz}.$
- $I_C = 70\text{ mA}; V_{CE} = 10\text{ V}; R_L = 75\text{ }^\Omega; T_{amb} = 25\text{ }^\circ\text{C};$
 $P_p = \text{ITO} - 6\text{ dB}; f_p = 800\text{ MHz};$
 $P_q = \text{ITO} - 6\text{ dB}; f_q = 801\text{ MHz};$
measured at $f_{(2p-q)} = 799\text{ MHz}.$

NPN 5 GHz wideband transistor

BFR96S

NON AMER PHILIPS/DISCRETE

69E D

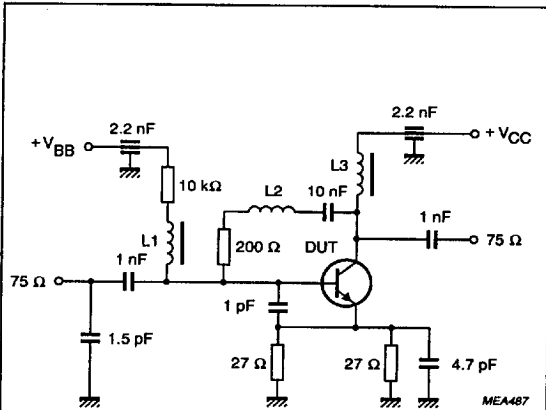

L1 = L3 = 5 μ H microchoke.
 L2 = 1.5 turns 0.4 mm copper wire; winding pitch 1 mm; internal diameter 3 mm.

Fig.2 Intermodulation distortion and second order intermodulation distortion test circuit.

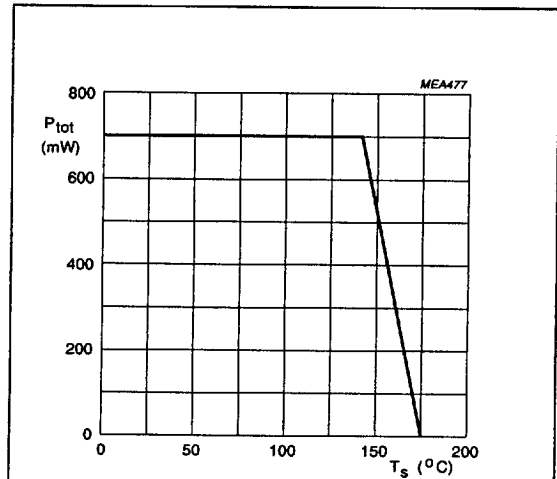
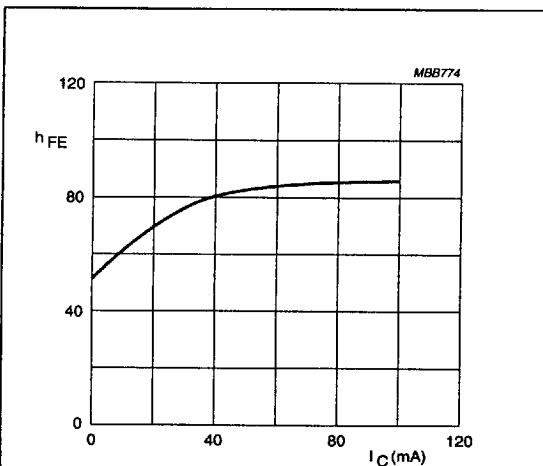
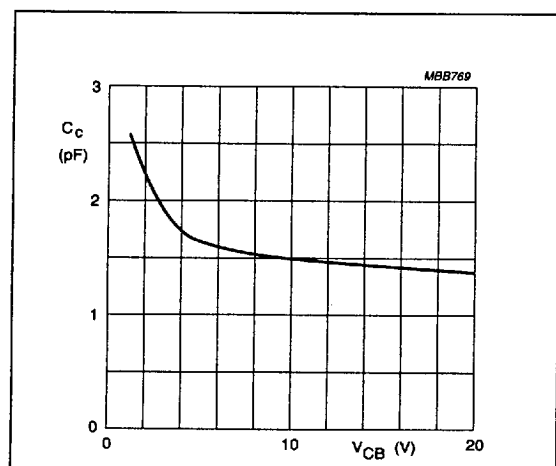

Fig.3 Power derating curve.



V_{CE} = 10 V; T_j = 25 °C.

Fig.4 DC current gain as a function of collector current.



I_E = I₀ = 0; f = 1 MHz; T_j = 25 °C.

Fig.5 Collector capacitance as a function of collector-base voltage.

NPN 5 GHz wideband transistor

BFR96S

N AMER PHILIPS/DISCRETE

69E D

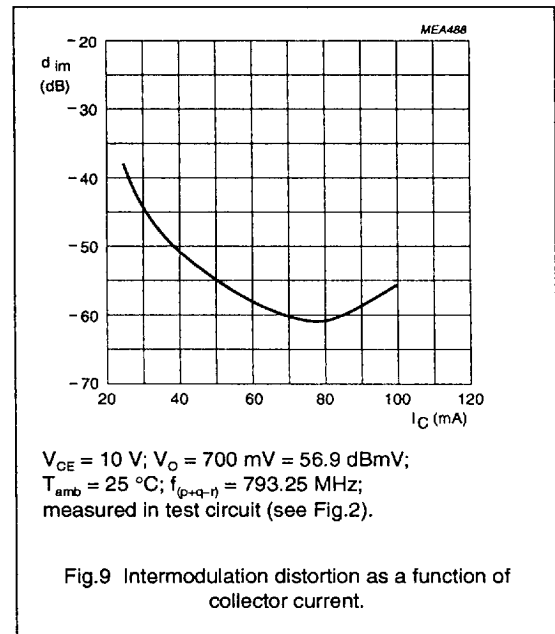
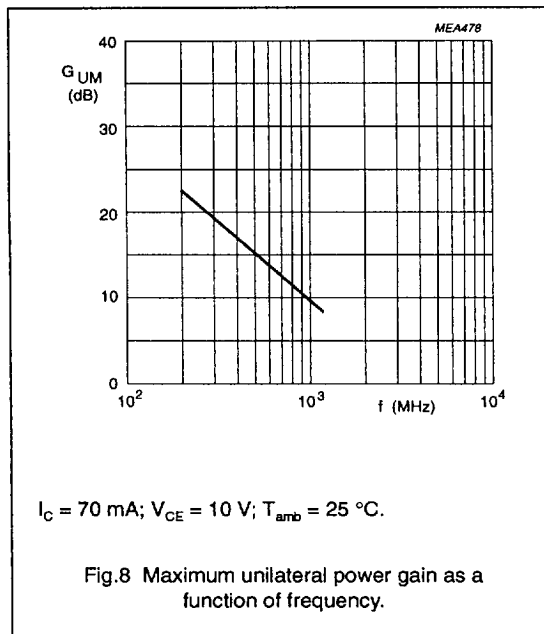
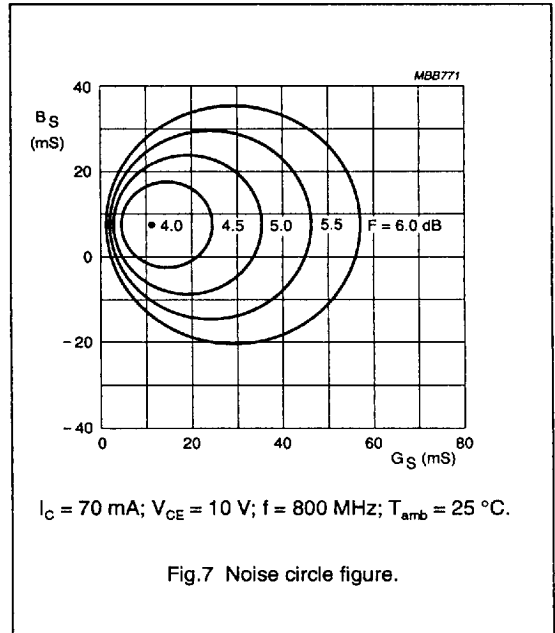
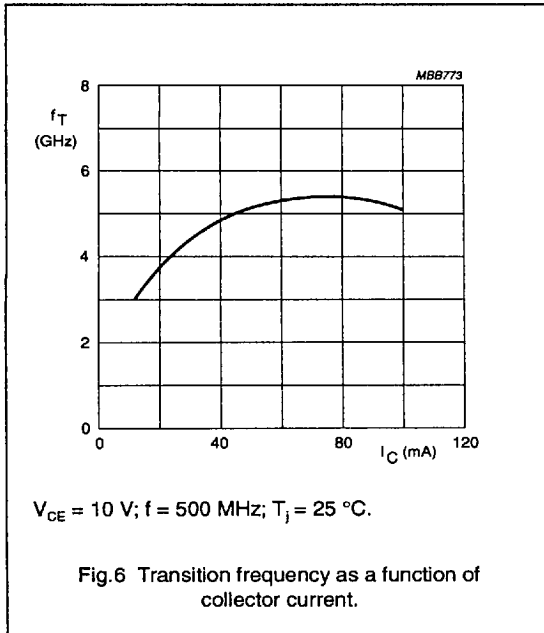

NPN 5 GHz wideband transistor

BFR96S

N AMER PHILIPS/DISCRETE

69E D

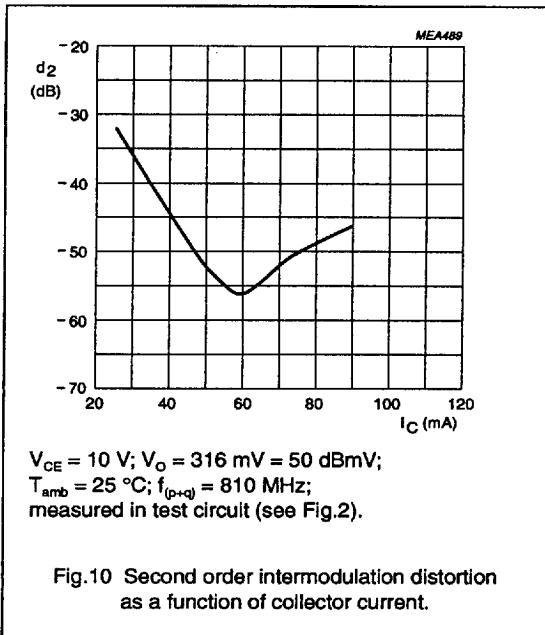

NPN 5 GHz wideband transistor

BFR96S

N AMER PHILIPS/DISCRETE

69E D

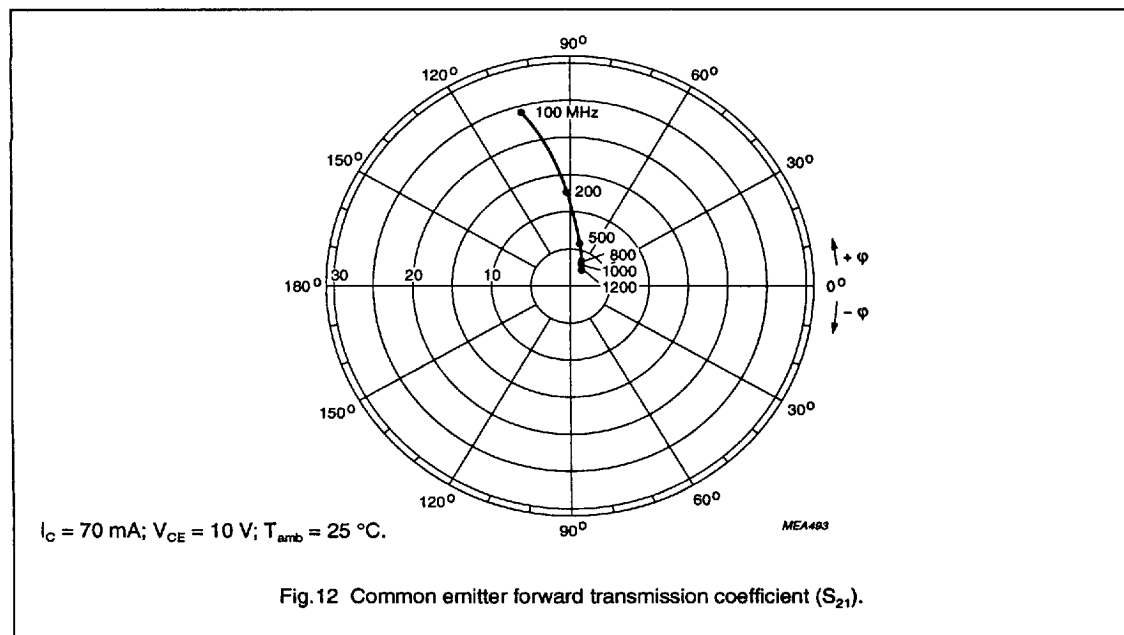
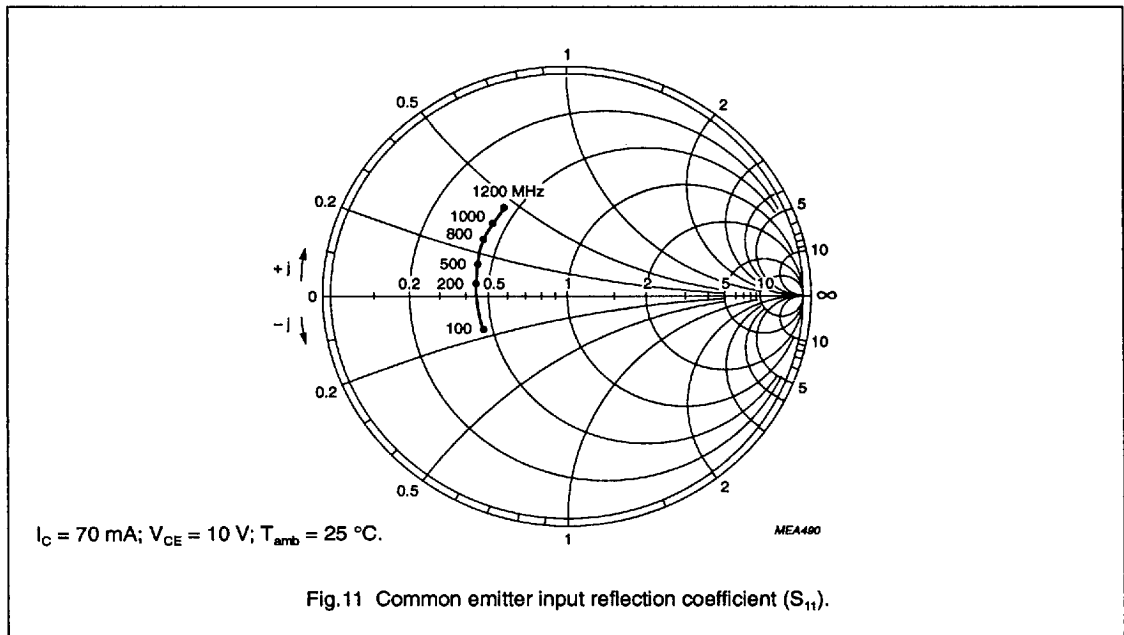

NPN 5 GHz wideband transistor

BFR96S

N AMER PHILIPS/DISCRETE

69E D -

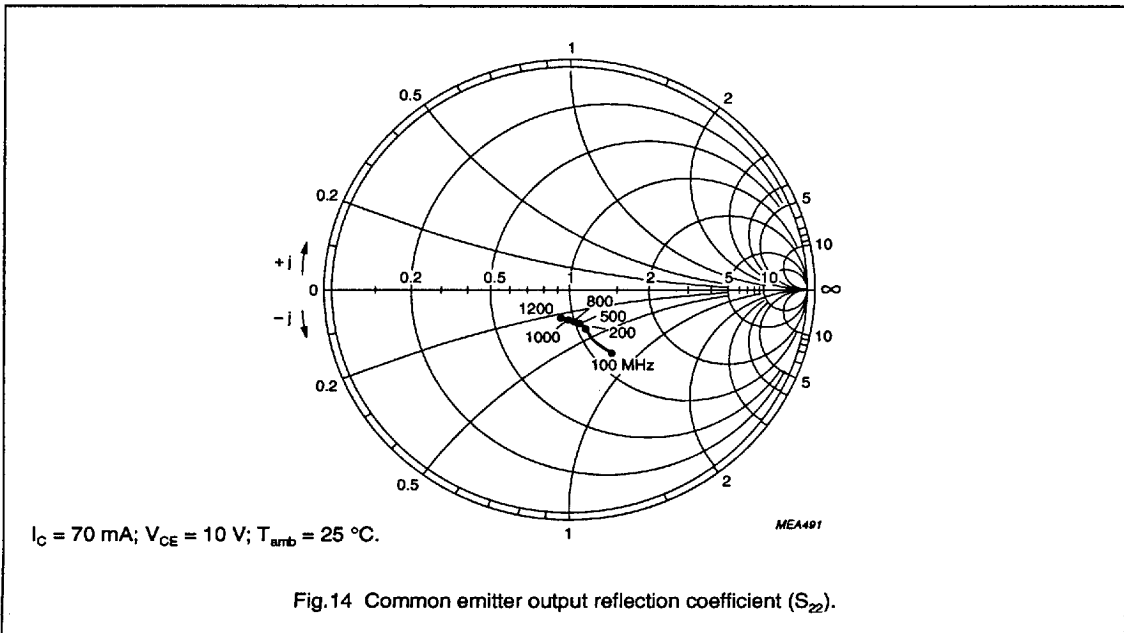
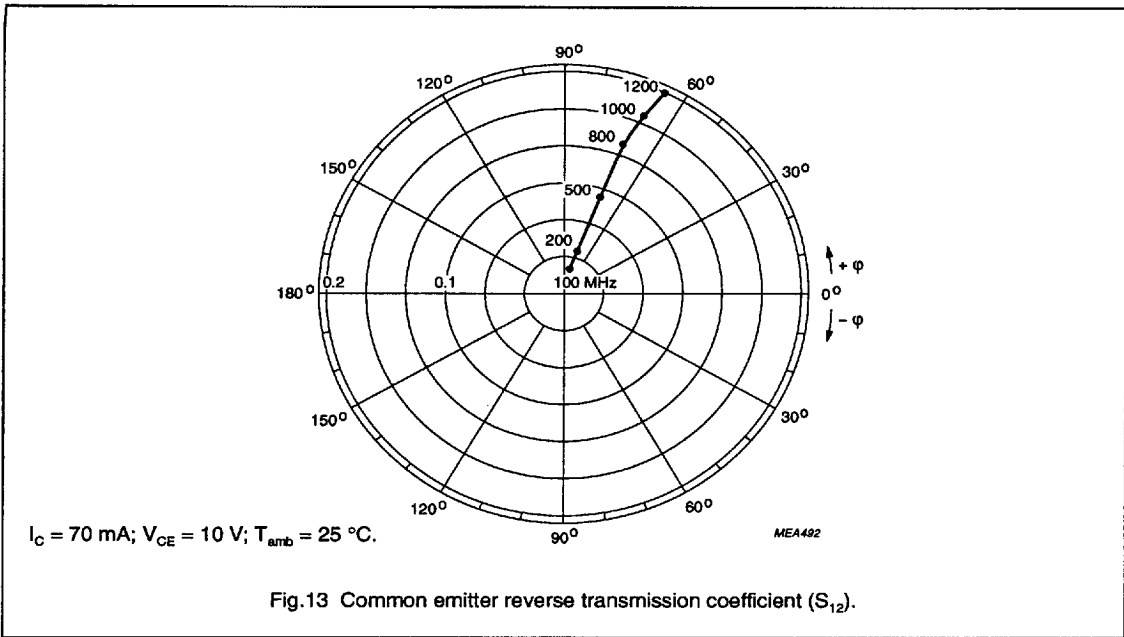

NPN 5 GHz wideband transistor

BFR96S

N AMER PHILIPS/DISCRETE

69E D -

Table 1 Common emitter scattering parameters, $I_C = 50$ mA; $V_{CE} = 10$ V

f (MHz)	S ₁₁		S ₂₁		S ₁₂		S ₂₂		G _{UM} (dB)
	MAG. (RAT)	ANG. (DEG)	MAG. (RAT)	ANG. (DEG)	MAG. (RAT)	ANG. (DEG)	MAG. (RAT)	ANG. (DEG)	
40	0.333	-96.0	49.624	130.8	0.012	70.5	0.648	-43.8	36.8
100	0.345	-144.7	25.627	107.3	0.023	67.5	0.348	-61.9	29.3
200	0.354	-168.9	13.375	94.2	0.041	73.3	0.208	-68.8	23.3
300	0.365	-179.7	9.016	87.9	0.058	74.3	0.165	-71.9	19.8
400	0.373	173.9	6.820	82.4	0.076	74.0	0.148	-76.4	17.4
500	0.380	166.6	5.483	78.7	0.092	73.3	0.143	-81.5	15.5
600	0.377	162.0	4.636	74.5	0.110	71.3	0.144	-85.9	14.1
700	0.377	158.1	3.983	71.4	0.128	70.5	0.146	-88.4	12.8
800	0.380	152.0	3.537	66.8	0.144	69.2	0.148	-91.5	11.7
900	0.375	145.1	3.151	63.9	0.160	67.9	0.151	-95.6	10.7
1000	0.376	141.4	2.846	61.3	0.175	66.4	0.151	-100.5	9.8
1200	0.422	131.9	2.411	55.0	0.206	63.4	0.156	-110.9	8.6
1400	0.424	123.3	2.097	47.8	0.233	60.2	0.173	-122.6	7.4
1600	0.452	117.1	1.869	42.5	0.261	58.0	0.192	-131.0	6.6
1800	0.448	112.1	1.707	37.0	0.288	53.6	0.213	-137.2	5.8
2000	0.488	100.5	1.556	33.1	0.311	51.0	0.221	-143.9	5.2
2200	0.506	94.5	1.483	28.3	0.333	48.3	0.232	-153.5	4.9
2400	0.524	88.7	1.351	22.5	0.355	46.6	0.251	-163.9	4.3
2600	0.560	86.2	1.262	19.6	0.379	43.0	0.282	-171.8	4.0
2800	0.547	78.5	1.183	14.6	0.387	39.7	0.313	-177.4	3.5
3000	0.563	71.9	1.114	10.6	0.406	38.5	0.330	177.4	3.1

NPN 5 GHz wideband transistor

BFR96S

N AMER PHILIPS/DISCRETE

69E D

Table 2 Common emitter scattering parameters, $I_C = 70$ mA; $V_{CE} = 10$ V

f (MHz)	S ₁₁		S ₂₁		S ₁₂		S ₂₂		G _{UM} (dB)
	MAG. (RAT)	ANG. (DEG)	MAG. (RAT)	ANG. (DEG)	MAG. (RAT)	ANG. (DEG)	MAG. (RAT)	ANG. (DEG)	
40	0.317	-109.4	52.636	127.2	0.011	66.9	0.596	-47.3	36.8
100	0.335	-151.1	26.034	105.0	0.023	70.4	0.306	-64.3	29.3
200	0.354	-172.6	13.450	92.9	0.041	73.9	0.184	-70.8	23.3
300	0.358	177.7	9.044	86.9	0.059	75.4	0.147	-74.5	19.8
400	0.368	173.9	6.852	82.0	0.075	75.2	0.135	-79.3	17.4
500	0.381	167.9	5.499	78.4	0.094	74.2	0.131	-84.4	15.6
600	0.373	160.3	4.641	74.2	0.111	71.7	0.135	-89.4	14.1
700	0.382	157.1	3.979	71.0	0.129	71.3	0.138	-92.1	12.8
800	0.377	151.7	3.551	66.7	0.145	69.6	0.139	-95.7	11.8
900	0.381	145.1	3.169	63.4	0.161	67.9	0.143	-99.2	10.8
1000	0.396	139.6	2.863	61.2	0.177	66.5	0.145	-103.8	10.0
1200	0.411	133.0	2.418	55.0	0.208	63.3	0.151	-114.5	8.6
1400	0.424	124.9	2.101	48.0	0.234	60.1	0.168	-126.8	7.4
1600	0.447	116.8	1.879	42.7	0.263	58.1	0.188	-134.4	6.6
1800	0.456	110.6	1.700	37.2	0.289	53.3	0.209	-140.5	5.8
2000	0.502	101.4	1.568	33.3	0.314	51.0	0.218	-147.2	5.4
2200	0.505	95.0	1.495	28.1	0.337	48.2	0.230	-156.3	5.0
2400	0.525	88.1	1.365	22.8	0.358	46.3	0.249	-166.9	4.4
2600	0.549	86.1	1.273	20.4	0.382	42.7	0.280	-174.6	4.0
2800	0.561	77.6	1.193	14.9	0.389	39.7	0.311	-179.7	3.6
3000	0.553	71.5	1.122	11.0	0.410	38.2	0.326	175.5	3.1