



# LM140,A Series LM340,A Series

## Specifications and Applications Information

### THREE-TERMINAL POSITIVE VOLTAGE REGULATORS

This family of fixed voltage regulators are monolithic integrated circuits capable of driving loads in excess of 1.0 ampere. These three-terminal regulators employ internal current limiting, thermal shutdown, and safe-area compensation. Devices are available with improved specifications, including a 2% output voltage tolerance, on A-suffix 5.0, 12 and 15 volt device types.

Although designed primarily as a fixed voltage regulator, these devices can be used with external components to obtain adjustable voltages and currents. This series of devices can be used with a series-pass transistor to boost output current capability at the nominal output voltage.

- Output Current in Excess of 1.0 Ampere
- No External Components Required
- Output Voltage Offered in 2% and 4% Tolerance\*
- Internal Thermal Overload Protection
- Internal Short-Circuit Current Limiting
- Output Transistor Safe-Area Compensation

**THREE-TERMINAL  
POSITIVE FIXED  
VOLTAGE REGULATORS**

**SILICON MONOLITHIC  
INTEGRATED CIRCUIT**

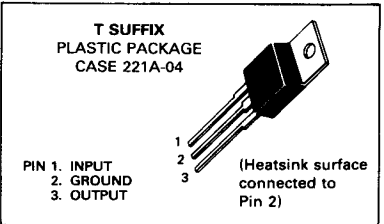
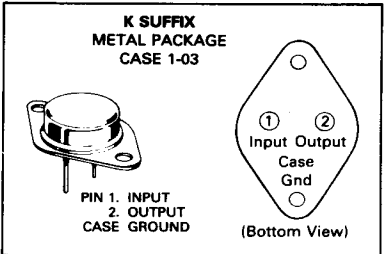

### ORDERING INFORMATION

Device	Output Voltage and Tolerance	Tested Operating Junction Temp. Range	Package
LM140K-5.0	5.0 V ± 4%	-55°C to +150°C	Metal Power
LM140AK-5.0	5.0 V ± 2%	-55°C to +150°C	Metal Power
LM140K-8.0	8.0 V ± 4%	-55°C to +150°C	Metal Power
LM140K-12	12 V ± 4%	-55°C to +150°C	Metal Power
LM140AK-12	12 V ± 2%	-55°C to +150°C	Metal Power
LM140K-15	15 V ± 4%	-55°C to +150°C	Metal Power
LM140AK-15	15 V ± 2%	-55°C to +150°C	Metal Power
LM340K-5.0	5.0 V ± 4%	0°C to +125°C	Metal Power
LM340AK-5.0	5.0 V ± 2%	0°C to +125°C	Plastic Power
LM340T-5.0	5.0 V ± 4%	0°C to +125°C	Plastic Power
LM340AT-5.0	5.0 V ± 2%	0°C to +125°C	Metal Power
LM340T-6.0	6.0 V ± 4%	0°C to +125°C	Plastic Power
LM340K-8.0	8.0 V ± 4%	0°C to +125°C	Metal Power
LM340T-8.0	8.0 V ± 4%	0°C to +125°C	Plastic Power
LM340K-12	12 V ± 4%	0°C to +125°C	Metal Power
LM340AK-12	12 V ± 2%	0°C to +125°C	Plastic Power
LM340T-12	12 V ± 4%	0°C to +125°C	Plastic Power
LM340AT-12	12 V ± 2%	0°C to +125°C	Metal Power
LM340K-15	15 V ± 4%	0°C to +125°C	Metal Power
LM340AK-15	15 V ± 2%	0°C to +125°C	Plastic Power
LM340T-15	15 V ± 4%	0°C to +125°C	Plastic Power
LM340AT-15	15 V ± 2%	0°C to +125°C	Metal Power
LM340T-18	18 V ± 4%	0°C to +125°C	Plastic Power
LM340T-24	24 V ± 4%	0°C to +125°C	Plastic Power

\*2% regulators are available in 5, 12 and 15 volt devices

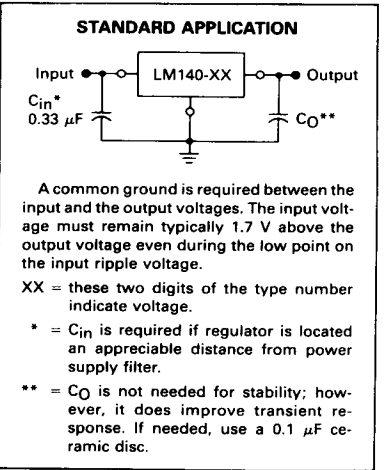

# LM140,A, LM340,A

3

## MAXIMUM RATINGS ( $T_A = +25^\circ\text{C}$ unless otherwise noted.)

Rating	Symbol	Value	Unit
Input Voltage (5.0 V - 18 V) (24 V)	$V_{in}$	35 40	Vdc
<b>Power Dissipation and Thermal Characteristics</b>			
<b>Plastic Package</b>			
$T_A = +25^\circ\text{C}$	$P_D$	Internally Limited	Watts
Derate above $T_A = +25^\circ\text{C}$	$1/\theta_{JA}$	15.4	$\text{mW}/^\circ\text{C}$
Thermal Resistance, Junction to Air	$\theta_{JA}$	65	$^\circ\text{C}/\text{W}$
$T_C = +25^\circ\text{C}$	$P_D$	Internally Limited	Watts
Derate above $T_C = +75^\circ\text{C}$ (See Figure 1)	$1/\theta_{JC}$	200	$\text{mW}/^\circ\text{C}$
Thermal Resistance, Junction to Case	$\theta_{JC}$	5.0	$^\circ\text{C}/\text{W}$
<b>Metal Package</b>			
$T_C = +25^\circ\text{C}$	$P_D$	Internally Limited	Watts
Derate above $T_A = +25^\circ\text{C}$	$1/\theta_{JA}$	22.5	$\text{mW}/^\circ\text{C}$
Thermal Resistance, Junction to Air	$\theta_{JA}$	45	$^\circ\text{C}/\text{W}$
$T_C = +25^\circ\text{C}$	$P_D$	Internally Limited	Watts
Derate above $T_C = +65^\circ\text{C}$ (See Figure 2)	$1/\theta_{JC}$	182	$\text{mW}/^\circ\text{C}$
Thermal Resistance, Junction to Case	$\theta_{JC}$	5.5	$^\circ\text{C}/\text{W}$
Storage Junction Temperature Range	$T_{stg}$	-65 to +150	$^\circ\text{C}$
Operating Junction Temperature Range	$T_J$	-55 to +150 0 to +150	$^\circ\text{C}$

## EQUIVALENT SCHEMATIC DIAGRAM

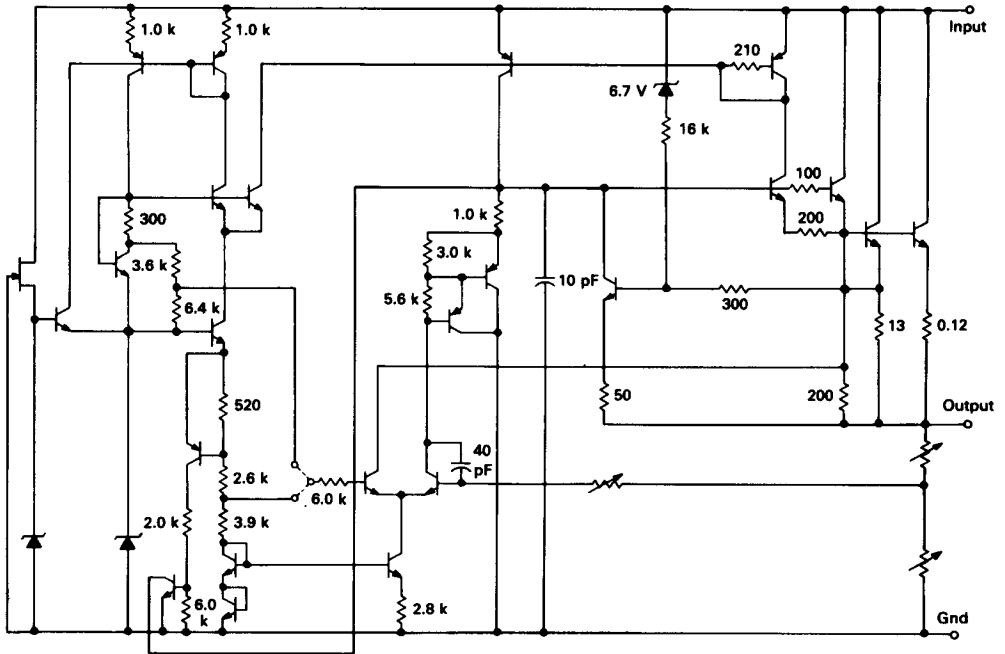

**DEFINITIONS**

**Line Regulation** — The change in output voltage for a change in the input voltage. The measurement is made under conditions of low dissipation or by using pulse techniques such that the average chip temperature is not significantly affected.

**Load Regulation** — The change in output voltage for a change in load current at constant chip temperature.

**Maximum Power Dissipation** — The maximum total device

dissipation for which the regulator will operate within specifications.

**Quiescent Current** — That part of the input current that is not delivered to the load.

**Output Noise Voltage** — The rms ac voltage at the output, with constant load and no input ripple, measured over a specified frequency range.

**LM140/340 — 5.0**

**ELECTRICAL CHARACTERISTICS** ( $V_{in} = 10\text{ V}$ ,  $I_O = 500\text{ mA}$ ,  $T_J = T_{low}$  to  $T_{high}$  (Note 1), unless otherwise noted).

Characteristic	Symbol	Min	Typ	Max	Unit
Output Voltage ( $T_J = +25^\circ\text{C}$ ) $I_O = 5.0\text{ mA}$ to $1.0\text{ A}$	$V_O$	4.8	5.0	5.2	Vdc
Line Regulation (Note 2) 8.0 to 20 Vdc 7.0 to 25 Vdc ( $T_J = +25^\circ\text{C}$ ) 8.0 to 12 Vdc, $I_O = 1.0\text{ A}$ 7.3 to 20 Vdc, $I_O = 1.0\text{ A}$ ( $T_J = +25^\circ\text{C}$ )	Regline	—	—	50 50 25 50	mV
Load Regulation (Note 2) 5.0 mA $\leq I_O \leq 1.0\text{ A}$ 5.0 mA $\leq I_O \leq 1.5\text{ A}$ ( $T_J = +25^\circ\text{C}$ ) 250 mA $\leq I_O \leq 750\text{ mA}$ ( $T_J = +25^\circ\text{C}$ )	Regload	—	—	50 50 25	mV
Output Voltage LM140 8.0 $\leq V_{in} \leq 20\text{ Vdc}$ , 5.0 mA $\leq I_O \leq 1.0\text{ A}$ , $P_D \leq 15\text{ W}$ LM340 7.0 $\leq V_{in} \leq 20\text{ Vdc}$ , 5.0 mA $\leq I_O \leq 1.0\text{ A}$ , $P_D \leq 15\text{ W}$	$V_O$	4.75	—	5.25	Vdc
Quiescent Current $I_O = 1.0\text{ A}$ LM140 LM340 LM140 ( $T_J = +25^\circ\text{C}$ ) LM340 ( $T_J = +25^\circ\text{C}$ )	$I_B$	—	—	7.0 8.5 6.0 8.0	mA
Quiescent Current Change 8.0 $\leq V_{in} \leq 25\text{ Vdc}$ , $I_O = 500\text{ mA}$ LM140 7.0 $\leq V_{in} \leq 25\text{ Vdc}$ , $I_O = 500\text{ mA}$ LM340 5.0 mA $\leq I_O \leq 1.0\text{ A}$ , $V_{in} = 10\text{ V}$ LM140, LM340 8.0 $\leq V_{in} \leq 20\text{ Vdc}$ , $I_O = 1.0\text{ A}$ LM140 7.5 $\leq V_{in} \leq 20\text{ Vdc}$ , $I_O = 1.0\text{ A}$ LM340	$\Delta I_B$	—	—	0.8 1.0 0.5 0.8 1.0	mA
Ripple Rejection LM140 LM340 $I_O = 1.0\text{ A}$ ( $T_J = +25^\circ\text{C}$ ) LM140 LM340	RR	68 62	— —	— —	dB
Dropout Voltage	$V_{in} - V_O$	—	1.7	—	Vdc
Output Resistance ( $f = 1.0\text{ kHz}$ )	$r_O$	—	2.0	—	m $\Omega$
Short Circuit Current Limit ( $T_J = +25^\circ\text{C}$ )	$I_{sc}$	—	2.0	—	mA
Output Noise Voltage ( $T_A = +25^\circ\text{C}$ ) 10 Hz $\leq f \leq 100\text{ kHz}$	$V_n$	—	40	—	$\mu\text{V}$
Average Temperature Coefficient of Output Voltage $I_O = 5.0\text{ mA}$	$TCV_O$	—	$\pm 0.6$	—	mV/ $^\circ\text{C}$
Peak Output Current ( $T_J = +25^\circ\text{C}$ )	$I_O$	—	2.4	—	A
Input Voltage to Maintain Line Regulation ( $T_J = +25^\circ\text{C}$ ) $I_O = 1.0\text{ A}$		7.3	—	—	Vdc

**NOTES:** 1.  $T_{low} = -55^\circ\text{C}$  for LM140  $T_{high} = +150^\circ\text{C}$  for LM140  
 $= 0^\circ\text{C}$  for LM340  $= +125^\circ\text{C}$  for LM340

2. Load and line regulation are specified at constant junction temperature. Changes in  $V_O$  due to heating effects must be taken into account separately. Pulse testing with low duty cycle is used.

# LM140,A, LM340,A

## LM140A/340A — 5.0

### ELECTRICAL CHARACTERISTICS ( $V_{in} = 10\text{ V}$ , $I_O = 1.0\text{ A}$ , $T_J = T_{low}$ to $T_{high}$ (Note 1), unless otherwise noted).

Characteristic	Symbol	Min	Typ	Max	Unit
Output Voltage ( $T_J = +25^\circ\text{C}$ ) $I_O = 5.0\text{ mA}$ to $1.0\text{ A}$	$V_O$	4.9	5.0	5.1	Vdc
Line Regulation (Note 2) 7.5 to 20 Vdc, $I_O = 500\text{ mA}$ 7.3 to 20 Vdc ( $T_J = +25^\circ\text{C}$ ) 8.0 to 12 Vdc 8.0 to 12 Vdc ( $T_J = +25^\circ\text{C}$ )	Reg <sub>line</sub>	—	— 3.0	10 10 12 4.0	mV
Load Regulation (Note 2) 5.0 mA $\leq I_O \leq 1.0\text{ A}$ 5.0 mA $\leq I_O \leq 1.5\text{ A}$ ( $T_J = +25^\circ\text{C}$ ) 250 mA $\leq I_O \leq 750\text{ mA}$ ( $T_J = +25^\circ\text{C}$ )	Reg <sub>load</sub>	—	—	25 25 15	mV
Output Voltage 7.5 $\leq V_{in} \leq 20\text{ Vdc}$ , 5.0 mA $\leq I_O \leq 1.0\text{ A}$ , $P_D \leq 15\text{ W}$	$V_O$	4.8	—	5.2	Vdc
Quiescent Current ( $T_J = +25^\circ\text{C}$ )	$I_B$	—	— 3.5	6.5 6.0	mA
Quiescent Current Change 5.0 mA $\leq I_O \leq 1.0\text{ A}$ , $V_{in} = 10\text{ V}$ 8.0 $\leq V_{in} \leq 25\text{ Vdc}$ , $I_O = 500\text{ mA}$ 7.5 $\leq V_{in} \leq 20\text{ Vdc}$ , $I_O = 1.0\text{ A}$ ( $T_J = +25^\circ\text{C}$ )	$\Delta I_B$	—	—	0.5 0.8 0.8	mA
Ripple Rejection 8.0 $\leq V_{in} \leq 18\text{ Vdc}$ , $f = 120\text{ Hz}$ $I_O = 500\text{ mA}$ $I_O = 1.0\text{ A}$ ( $T_J = +25^\circ\text{C}$ )	RR	68 68	— 80	— —	dB
Dropout Voltage	$V_{in} - V_O$	—	1.7	—	Vdc
Output Resistance ( $f = 1.0\text{ kHz}$ )	$r_O$	—	2.0	—	m $\Omega$
Short Circuit Current Limit ( $T_J = +25^\circ\text{C}$ )	$I_{sc}$	—	2.0	—	mA
Output Noise Voltage ( $T_A = +25^\circ\text{C}$ ) 10 Hz $\leq f \leq 100\text{ kHz}$	$V_n$	—	40	—	$\mu\text{V}$
Average Temperature Coefficient of Output Voltage $I_O = 5.0\text{ mA}$	$TCV_O$	—	$\pm 0.6$	—	mV/ $^\circ\text{C}$
Peak Output Current ( $T_J = +25^\circ\text{C}$ )	$I_O$	—	2.4	—	A
Input Voltage to Maintain Line Regulation ( $T_J = +25^\circ\text{C}$ )		7.3	—	—	Vdc

#### NOTES:

1.  $T_{low} = -55^\circ\text{C}$  for LM140A     $T_{high} = +150^\circ\text{C}$  for LM140A  
       =  $0^\circ\text{C}$  for LM340A        =  $+125^\circ\text{C}$  for LM340A

2. Load and line regulation are specified at constant junction temperature. Changes in  $V_O$  due to heating effects must be taken into account separately. Pulse testing with low duty cycle is used.

LM140/340 — 6.0

ELECTRICAL CHARACTERISTICS ( $V_{in} = 11\text{ V}$ ,  $I_O = 500\text{ mA}$ ,  $T_J = T_{low}$  to  $T_{high}$  (Note 1), unless otherwise noted).

Characteristic	Symbol	Min	Typ	Max	Unit
Output Voltage ( $T_J = +25^\circ\text{C}$ ) $I_O = 5.0\text{ mA}$ to $1.0\text{ A}$	$V_O$	5.75	6.0	6.25	Vdc
Line Regulation (Note 2) 9.0 to 21 Vdc 8.0 to 25 Vdc ( $T_J = +25^\circ\text{C}$ ) 9.0 to 13 Vdc, $I_O = 1.0\text{ A}$ 8.3 to 21 Vdc, $I_O = 1.0\text{ A}$ ( $T_J = +25^\circ\text{C}$ )	Regline	—	—	60 60 30 60	mV
Load Regulation (Note 2) $5.0\text{ mA} \leq I_O \leq 1.0\text{ A}$ $5.0\text{ mA} \leq I_O \leq 1.5\text{ A}$ ( $T_J = +25^\circ\text{C}$ ) $250\text{ mA} \leq I_O \leq 750\text{ mA}$ ( $T_J = +25^\circ\text{C}$ )	Regload	—	—	60 60 30	mV
Output Voltage LM140 9.0 $\leq V_{in} \leq 21\text{ Vdc}$ , $5.0\text{ mA} \leq I_O \leq 1.0\text{ A}$ , $P_D \leq 15\text{ W}$ LM340 8.0 $\leq V_{in} \leq 21\text{ Vdc}$ , $6.0\text{ mA} \leq I_O \leq 1.0\text{ A}$ , $P_D \leq 15\text{ W}$	$V_O$	5.7	—	6.3	Vdc
Quiescent Current $I_O = 1.0\text{ A}$ LM140 LM340 LM140 ( $T_J = +25^\circ\text{C}$ ) LM340 ( $T_J = +25^\circ\text{C}$ )	$I_B$	—	—	7.0 8.5 6.0 8.0	mA
Quiescent Current Change 9.0 $\leq V_{in} \leq 25\text{ Vdc}$ , $I_O = 500\text{ mA}$ LM140 8.0 $\leq V_{in} \leq 25\text{ Vdc}$ , $I_O = 500\text{ mA}$ LM340 5.0 mA $\leq I_O \leq 1.0\text{ A}$ , $V_{in} = 11\text{ V}$ LM140, LM340 9.0 $\leq V_{in} \leq 21\text{ Vdc}$ , $I_O = 1.0\text{ A}$ LM140 8.6 $\leq V_{in} \leq 21\text{ Vdc}$ , $I_O = 1.0\text{ A}$ LM340	$\Delta I_B$	—	—	0.8 1.0 0.5 0.8 1.0	mA
Ripple Rejection LM140 LM340 $I_O = 1.0\text{ A}$ ( $T_J = +25^\circ\text{C}$ ) LM140 LM340	RR	65 59	— —	— —	dB
Dropout Voltage	$V_{in} - V_O$	—	1.7	—	Vdc
Output Resistance ( $f = 1.0\text{ kHz}$ )	$r_O$	—	2.0	—	m $\Omega$
Short Circuit Current Limit ( $T_J = +25^\circ\text{C}$ )	$I_{sc}$	—	1.9	—	mA
Output Noise Voltage ( $T_A = +25^\circ\text{C}$ ) 10 Hz $\leq f \leq 100\text{ kHz}$	$V_n$	—	45	—	$\mu\text{V}$
Average Temperature Coefficient of Output Voltage $I_O = 5.0\text{ mA}$	$TCV_O$	—	$\pm 0.7$	—	mV/ $^\circ\text{C}$
Peak Output Current ( $T_J = +25^\circ\text{C}$ )	$I_O$	—	2.4	—	A
Input Voltage to Maintain Line Regulation ( $T_J = +25^\circ\text{C}$ ) $I_O = 1.0\text{ A}$		8.3	—	—	Vdc

NOTES:

1.  $T_{low} = -55^\circ\text{C}$  for LM140       $T_{high} = +150^\circ\text{C}$  for LM140  
        $= 0^\circ\text{C}$  for LM340                 $= +125^\circ\text{C}$  for LM340
2. Load and line regulation are specified at constant junction temperature. Changes in  $V_O$  due to heating effects must be taken into account separately. Pulse testing with low duty cycle is used.



# LM140,A, LM340,A

## LM140/340 — 8.0

**ELECTRICAL CHARACTERISTICS** ( $V_{in} = 14\text{ V}$ ,  $I_O = 500\text{ mA}$ ,  $T_J = T_{low}$  to  $T_{high}$  (Note 1), unless otherwise noted).

Characteristic	Symbol	Min	Typ	Max	Unit
Output Voltage ( $T_J = +25^\circ\text{C}$ ) $I_O = 5.0\text{ mA}$ to $1.0\text{ A}$	$V_O$	7.7	8.0	8.3	Vdc
Line Regulation (Note 2) 11 to 23 Vdc 10.5 to 25 Vdc ( $T_J = +25^\circ\text{C}$ ) 11 to 17 Vdc, $I_O = 1.0\text{ A}$ 10.5 to 23 Vdc, $I_O = 1.0\text{ A}$ ( $T_J = +25^\circ\text{C}$ )	Regline	—	—	80	mV
Load Regulation (Note 2) $5.0\text{ mA} \leq I_O \leq 1.0\text{ A}$ $5.0\text{ mA} \leq I_O \leq 1.5\text{ A}$ ( $T_J = +25^\circ\text{C}$ ) $250\text{ mA} \leq I_O \leq 750\text{ mA}$ ( $T_J = +25^\circ\text{C}$ )	Regload	—	—	80	mV
Output Voltage LM140 $11.5 \leq V_{in} \leq 23\text{ Vdc}$ , $5.0\text{ mA} \leq I_O \leq 1.0\text{ A}$ , $P_D \leq 15\text{ W}$ LM340 $10.5 \leq V_{in} \leq 23\text{ Vdc}$ , $5.0\text{ mA} \leq I_O \leq 1.0\text{ A}$ , $P_D \leq 15\text{ W}$	$V_O$	7.6	—	8.4	Vdc
Quiescent Current $I_O = 1.0\text{ A}$ LM140 LM340 LM140 ( $T_J = +25^\circ\text{C}$ ) LM340 ( $T_J = +25^\circ\text{C}$ )	$I_B$	—	—	7.0	mA
Quiescent Current Change $11.5 \leq V_{in} \leq 25\text{ Vdc}$ , $I_O = 500\text{ mA}$ LM140 $10.5 \leq V_{in} \leq 25\text{ Vdc}$ , $I_O = 500\text{ mA}$ LM340 $5.0\text{ mA} \leq I_O \leq 1.0\text{ A}$ , $V_{in} = 14\text{ V}$ LM140, LM340 $11.5 \leq V_{in} \leq 23\text{ Vdc}$ , $I_O = 1.0\text{ A}$ LM140 $10.6 \leq V_{in} \leq 23\text{ Vdc}$ , $I_O = 1.0\text{ A}$ LM340	$\Delta I_B$	—	—	0.8	mA
Ripple Rejection LM140 LM340 $I_O = 1.0\text{ A}$ ( $T_J = +25^\circ\text{C}$ ) LM140 LM340	RR	62	—	—	dB
Dropout Voltage	$V_{in} - V_O$	—	1.7	—	Vdc
Output Resistance ( $f = 1.0\text{ kHz}$ )	$r_O$	—	2.0	—	m $\Omega$
Short Circuit Current Limit ( $T_J = +25^\circ\text{C}$ )	$I_{sc}$	—	1.5	—	mA
Output Noise Voltage ( $T_A = +25^\circ\text{C}$ ) $10\text{ Hz} \leq f \leq 100\text{ kHz}$	$V_n$	—	52	—	$\mu\text{V}$
Average Temperature Coefficient of Output Voltage $I_O = 5.0\text{ mA}$	$TCV_O$	—	$\pm 1.0$	—	mV/ $^\circ\text{C}$
Peak Output Current ( $T_J = +25^\circ\text{C}$ )	$I_O$	—	2.4	—	A
Input Voltage to Maintain Line Regulation ( $T_J = +25^\circ\text{C}$ ) $I_O = 1.0\text{ A}$		10.5	—	—	Vdc

**NOTES:**

1.  $T_{low} = -55^\circ\text{C}$  for LM140       $T_{high} = +150^\circ\text{C}$  for LM140  
       $= 0^\circ\text{C}$  for LM340                 $= +125^\circ\text{C}$  for LM340

2. Load and line regulation are specified at constant junction temperature. Changes in  $V_O$  due to heating effects must be taken into account separately. Pulse testing with low duty cycle is used.

# LM140,A, LM340,A

## LM140/340 — 12

### ELECTRICAL CHARACTERISTICS ( $V_{in} = 19\text{ V}$ , $I_O = 500\text{ mA}$ , $T_J = T_{low}$ to $T_{high}$ (Note 1), unless otherwise noted).

Characteristic	Symbol	Min	Typ	Max	Unit
Output Voltage ( $T_J = +25^\circ\text{C}$ ) $I_O = 5.0\text{ mA}$ to $1.0\text{ A}$	$V_O$	11.5	12	12.5	Vdc
Line Regulation (Note 2) 15 to 27 Vdc 14.6 to 30 Vdc ( $T_J = +25^\circ\text{C}$ ) 16 to 22 Vdc, $I_O = 1.0\text{ A}$ 14.6 to 27 Vdc, $I_O = 1.0\text{ A}$ ( $T_J = +25^\circ\text{C}$ )	Reg <sub>line</sub>	—	—	120 120 60 120	mV
Load Regulation (Note 2) $5.0\text{ mA} \leq I_O \leq 1.0\text{ A}$ $5.0\text{ mA} \leq I_O \leq 1.5\text{ A}$ ( $T_J = +25^\circ\text{C}$ ) $250\text{ mA} \leq I_O \leq 750\text{ mA}$ ( $T_J = +25^\circ\text{C}$ )	Reg <sub>load</sub>	—	—	120 120 60	mV
Output Voltage LM140 $15.5 \leq V_{in} \leq 27\text{ Vdc}$ , $5.0\text{ mA} \leq I_O \leq 1.0\text{ A}$ , $P_D \leq 15\text{ W}$ LM340 $14.5 \leq V_{in} \leq 27\text{ Vdc}$ , $5.0\text{ mA} \leq I_O \leq 1.0\text{ A}$ , $P_D \leq 15\text{ W}$	$V_O$	11.4	—	12.6	Vdc
Quiescent Current $I_O = 1.0\text{ A}$ LM140 LM340 LM140 ( $T_J = +25^\circ\text{C}$ ) LM340 ( $T_J = +25^\circ\text{C}$ )	$I_B$	—	—	7.0 8.5 6.0 8.0	mA
Quiescent Current Change $15 \leq V_{in} \leq 30\text{ Vdc}$ , $I_O = 500\text{ mA}$ LM140 $14.5 \leq V_{in} \leq 30\text{ Vdc}$ , $I_O = 500\text{ mA}$ LM340 $5.0\text{ mA} \leq I_O \leq 1.0\text{ A}$ , $V_{in} = 19\text{ V}$ LM140, LM340 $15 \leq V_{in} \leq 27\text{ Vdc}$ , $I_O = 1.0\text{ A}$ LM140 $14.8 \leq V_{in} \leq 27\text{ Vdc}$ , $I_O = 1.0\text{ A}$ LM340	$\Delta I_B$	—	—	0.8 1.0 0.5 0.8 1.0	mA
Ripple Rejection LM140 LM340 $I_O = 1.0\text{ A}$ ( $T_J = +25^\circ\text{C}$ ) LM140 LM340	RR	61 55	— —	— —	dB
Dropout Voltage	$V_{in} - V_O$	—	1.7	—	Vdc
Output Resistance ( $f = 1.0\text{ kHz}$ )	$r_O$	—	2.0	—	$m\Omega$
Short Circuit Current Limit ( $T_J = +25^\circ\text{C}$ )	$I_{sc}$	—	1.1	—	mA
Output Noise Voltage ( $T_A = +25^\circ\text{C}$ ) $10\text{ Hz} \leq f \leq 100\text{ kHz}$	$V_n$	—	75	—	$\mu\text{V}$
Average Temperature Coefficient of Output Voltage $I_O = 5.0\text{ mA}$	$TCV_O$	—	$\pm 1.5$	—	$\text{mV}/^\circ\text{C}$
Peak Output Current ( $T_J = +25^\circ\text{C}$ )	$I_O$	—	2.4	—	A
Input Voltage to Maintain Line Regulation ( $T_J = +25^\circ\text{C}$ ) $I_O = 1.0\text{ A}$		14.6	—	—	Vdc

#### NOTES:

- $T_{low} = -55^\circ\text{C}$  for LM140      $T_{high} = +150^\circ\text{C}$  for LM140  
 $= +125^\circ\text{C}$  for LM340
- Load and line regulation are specified at constant junction temperature. Changes in  $V_O$  due to heating effects must be taken into account separately. Pulse testing with low duty cycle is used.

# LM140,A, LM340,A

## LM140A/340A — 12

### ELECTRICAL CHARACTERISTICS ( $V_{in} = 19\text{ V}$ , $I_O = 1.0\text{ A}$ , $T_J = T_{low}$ to $T_{high}$ (Note 1), unless otherwise noted).

Characteristic	Symbol	Min	Typ	Max	Unit
Output Voltage ( $T_J = +25^\circ\text{C}$ ) $I_O = 5.0\text{ mA}$ to $1.0\text{ A}$	$V_O$	11.75	12	12.25	Vdc
Line Regulation (Note 2) 14.8 to 27 Vdc, $I_O = 500\text{ mA}$ 14.5 to 27 Vdc ( $T_J = +25^\circ\text{C}$ ) 16 to 22 Vdc 16 to 22 Vdc ( $T_J = +25^\circ\text{C}$ )	Regline	—	—	18	mV
		—	4.0	18	
		—	—	30	
		—	—	9.0	
Load Regulation (Note 2) $5.0\text{ mA} \leq I_O \leq 1.0\text{ A}$ $5.0\text{ mA} \leq I_O \leq 1.5\text{ A}$ ( $T_J = +25^\circ\text{C}$ ) $250\text{ mA} \leq I_O \leq 750\text{ mA}$ ( $T_J = +25^\circ\text{C}$ )	Regload	—	—	60	mV
		—	—	32	
		—	—	19	
Output Voltage $14.8 \leq V_{in} \leq 27\text{ Vdc}$ , $5.0\text{ mA} \leq I_O \leq 1.0\text{ A}$ , $P_D \leq 15\text{ W}$	$V_O$	11.5	—	12.5	Vdc
Quiescent Current ( $T_J = +25^\circ\text{C}$ )	$I_B$	—	—	6.5	mA
		—	3.5	6.0	
Quiescent Current Change $5.0\text{ mA} \leq I_O \leq 1.0\text{ A}$ , $V_{in} = 19\text{ V}$ $15 \leq V_{in} \leq 30\text{ Vdc}$ , $I_O = 500\text{ mA}$ $14.8 \leq V_{in} \leq 27\text{ Vdc}$ , $I_O = 1.0\text{ A}$ ( $T_J = +25^\circ\text{C}$ )	$\Delta I_B$	—	—	0.5	mA
		—	—	0.8	
		—	—	0.8	
Ripple Rejection $15 \leq V_{in} \leq 25\text{ Vdc}$ , $f = 120\text{ Hz}$ $I_O = 500\text{ mA}$ $I_O = 1.0\text{ A}$ , ( $T_J = +25^\circ\text{C}$ )	RR	61	—	—	dB
		61	72	--	
Dropout Voltage	$V_{in} - V_O$	—	1.7	—	Vdc
Output Resistance ( $f = 1.0\text{ kHz}$ )	$r_O$	—	2.0	—	m $\Omega$
Short Circuit Current Limit ( $T_J = +25^\circ\text{C}$ )	$I_{sc}$	—	1.1	—	mA
Output Noise Voltage ( $T_A = +25^\circ\text{C}$ ) $10\text{ Hz} \leq f \leq 100\text{ kHz}$	$V_n$	—	75	—	$\mu\text{V}$
Average Temperature Coefficient of Output Voltage $I_O = 5.0\text{ mA}$	$TCV_O$	—	$\pm 1.5$	—	mV/ $^\circ\text{C}$
Peak Output Current ( $T_J = +25^\circ\text{C}$ )	$I_O$	—	2.4	—	A
Input Voltage to Maintain Line Regulation ( $T_J = +25^\circ\text{C}$ )		14.5	—	—	Vdc

#### NOTES:

- $T_{low} = -55^\circ\text{C}$  for LM140A     $T_{high} = +150^\circ\text{C}$  for LM140A  
 $= 0^\circ\text{C}$  for LM340A                 $= +125^\circ\text{C}$  for LM340A
- Load and line regulation are specified at constant junction temperature. Changes in  $V_O$  due to heating effects must be taken into account separately. Pulse testing with low duty cycle is used.



**LM140A/340 — 15**
**ELECTRICAL CHARACTERISTICS** ( $V_{in} = 23\text{ V}$ ,  $I_O = 500\text{ mA}$ ,  $T_J = T_{low}$  to  $T_{high}$  (Note 1), unless otherwise noted).

Characteristic	Symbol	Min	Typ	Max	Unit
Output Voltage ( $T_J = +25^\circ\text{C}$ ) $I_O = 5.0\text{ mA}$ to $1.0\text{ A}$	$V_O$	14.4	15	15.6	Vdc
Line Regulation (Note 2) 18.5 to 30 Vdc 17.5 to 30 Vdc ( $T_J = +25^\circ\text{C}$ ) 20 to 26 Vdc, $I_O = 1.0\text{ A}$ 17.7 to 30 Vdc, $I_O = 1.0\text{ A}$ ( $T_J = +25^\circ\text{C}$ )	Regline	—	—	150 150 75 150	mV
Load Regulation (Note 2) $5.0\text{ mA} \leq I_O \leq 1.0\text{ A}$ $5.0\text{ mA} \leq I_O \leq 1.5\text{ A}$ ( $T_J = +25^\circ\text{C}$ ) $250\text{ mA} \leq I_O \leq 750\text{ mA}$ ( $T_J = +25^\circ\text{C}$ )	Regload	—	—	150 150 75	mV
Output Voltage LM140 $18.5 \leq V_{in} \leq 30\text{ Vdc}$ , $5.0\text{ mA} \leq I_O \leq 1.0\text{ A}$ , $P_D \leq 15\text{ W}$ LM340 $17.5 \leq V_{in} \leq 30\text{ Vdc}$ , $5.0\text{ mA} \leq I_O \leq 1.0\text{ A}$ , $P_D \leq 15\text{ W}$	$V_O$	14.25	—	15.75	Vdc
Quiescent Current $I_O = 1.0\text{ A}$ LM140 LM340 LM140 ( $T_J = +25^\circ\text{C}$ ) LM340 ( $T_J = +25^\circ\text{C}$ )	$I_B$	—	—	7.0 8.5 6.0 8.0	mA
Quiescent Current Change $18.5 \leq V_{in} \leq 30\text{ Vdc}$ , $I_O = 500\text{ mA}$ LM140 $17.5 \leq V_{in} \leq 30\text{ Vdc}$ , $I_O = 500\text{ mA}$ LM340 $5.0\text{ mA} \leq I_O \leq 1.0\text{ A}$ , $V_{in} = 23\text{ V}$ LM140, LM340 $18.5 \leq V_{in} \leq 30\text{ Vdc}$ , $I_O = 1.0\text{ A}$ LM140 $17.9 \leq V_{in} \leq 30\text{ Vdc}$ , $I_O = 1.0\text{ A}$ LM340	$\Delta I_B$	—	—	0.8 1.0 0.5 0.8 1.0	mA
Ripple Rejection LM140 LM340 $I_O = 1.0\text{ A}$ ( $T_J = +25^\circ\text{C}$ ) LM140 LM340	RR	60 54	— —	— —	dB
Dropout Voltage	$V_{in} - V_O$	—	1.7	—	Vdc
Output Resistance ( $f = 1.0\text{ kHz}$ )	$r_O$	—	2.0	—	m $\Omega$
Short Circuit Current Limit ( $T_J = +25^\circ\text{C}$ )	$I_{sc}$	—	800	—	mA
Output Noise Voltage ( $T_A = +25^\circ\text{C}$ ) $10\text{ Hz} \leq f \leq 100\text{ kHz}$	$V_n$	—	90	—	$\mu\text{V}$
Average Temperature Coefficient of Output Voltage $I_O = 5.0\text{ mA}$	$TCV_O$	—	$\pm 1.8$	—	mV/ $^\circ\text{C}$
Peak Output Current ( $T_J = +25^\circ\text{C}$ )	$I_O$	—	2.4	—	A
Input Voltage to Maintain Line Regulation ( $T_J = +25^\circ\text{C}$ ) $I_O = 1.0\text{ A}$		17.7	—	—	Vdc

**NOTES:**

1.  $T_{low} = -55^\circ\text{C}$  for LM140  $T_{high} = +150^\circ\text{C}$  for LM140  
 $T_{low} = -55^\circ\text{C}$  for LM340  $T_{high} = +125^\circ\text{C}$  for LM340
2. Load and line regulation are specified at constant junction temperature. Changes in  $V_O$  due to heating effects must be taken into account separately. Pulse testing with low duty cycle is used.

# LM140,A, LM340,A

## LM140A/340A — 15

**ELECTRICAL CHARACTERISTICS** ( $V_{in} = 23\text{ V}$ ,  $I_O = 1.0\text{ A}$ ,  $T_J = T_{low}$  to  $T_{high}$  (Note 1), unless otherwise noted).

Characteristic	Symbol	Min	Typ	Max	Unit
Output Voltage ( $T_J = +25^\circ\text{C}$ ) $I_O = 5.0\text{ mA}$ to $1.0\text{ A}$	$V_O$	14.7	15	15.3	Vdc
Line Regulation (Note 2) 17.9 to 30 Vdc, $I_O = 500\text{ mA}$ 17.5 to 30 Vdc ( $T_J = +25^\circ\text{C}$ ) 20 to 26 Vdc, $I_O = 1.0\text{ A}$ 20 to 26 Vdc, $I_O = 1.0\text{ A}$ ( $T_J = +25^\circ\text{C}$ )	Reg <sub>line</sub>	—	— 4.0	22 22 30 10	mV
Load Regulation (Note 2) $5.0\text{ mA} \leq I_O \leq 1.0\text{ A}$ $5.0\text{ mA} \leq I_O \leq 1.5\text{ A}$ ( $T_J = +25^\circ\text{C}$ ) $250\text{ mA} \leq I_O \leq 750\text{ mA}$ ( $T_J = +25^\circ\text{C}$ )	Reg <sub>load</sub>	—	— 12	75 35 21	mV
Output Voltage $17.9 \leq V_{in} \leq 30\text{ Vdc}$ , $5.0\text{ mA} \leq I_O \leq 1.0\text{ A}$ , $P_D \leq 15\text{ W}$	$V_O$	14.4	—	15.6	Vdc
Quiescent Current ( $T_J = +25^\circ\text{C}$ )	$I_B$	—	— 3.5	6.5 6.0	mA
Quiescent Current Change $5.0\text{ mA} \leq I_O \leq 1.0\text{ A}$ , $V_{in} = 23\text{ V}$ $17.9 \leq V_{in} \leq 30\text{ Vdc}$ , $I_O = 500\text{ mA}$ $17.9 \leq V_{in} \leq 30\text{ Vdc}$ , $I_O = 1.0\text{ A}$ ( $T_J = +25^\circ\text{C}$ )	$\Delta I_B$	—	—	0.5 0.8 0.8	mA
Ripple Rejection $18.5 \leq V_{in} \leq 28.5\text{ Vdc}$ , $f = 120\text{ Hz}$ $I_O = 500\text{ mA}$ $I_O = 1.0\text{ A}$ , ( $T_J = +25^\circ\text{C}$ )	RR	60 60	— 70	—	dB
Dropout Voltage	$V_{in} - V_O$	—	1.7	—	Vdc
Output Resistance ( $f = 1.0\text{ kHz}$ )	$r_O$	—	2.0	—	m $\Omega$
Short Circuit Current Limit ( $T_J = +25^\circ\text{C}$ )	$I_{sc}$	—	800	—	mA
Output Noise Voltage ( $T_A = +25^\circ\text{C}$ ) $10\text{ Hz} \leq f \leq 100\text{ kHz}$	$V_n$	—	90	—	$\mu\text{V}$
Average Temperature Coefficient of Output Voltage $I_O = 5.0\text{ mA}$	$TCV_O$	—	$\pm 1.8$	—	mV/ $^\circ\text{C}$
Peak Output Current ( $T_J = +25^\circ\text{C}$ )	$I_O$	—	2.4	—	A
Input Voltage to Maintain Line Regulation ( $T_J = +25^\circ\text{C}$ )		17.5	—	—	Vdc

**NOTES:**

1.  $T_{low} = -55^\circ\text{C}$  for LM140A     $T_{high} = +150^\circ\text{C}$  for LM140A  
        $\quad \quad \quad = 0^\circ\text{C}$  for LM340A         $\quad \quad \quad = +125^\circ\text{C}$  for LM340A

2. Load and line regulation are specified at constant junction temperature. Changes in  $V_O$  due to heating effects must be taken into account separately. Pulse testing with low duty cycle is used.

# LM140,A, LM340,A

## LM140/340 — 18

### ELECTRICAL CHARACTERISTICS ( $V_{in} = 27\text{ V}$ , $I_O = 500\text{ mA}$ , $T_J = T_{low}$ to $T_{high}$ (Note 1), unless otherwise noted).

Characteristic	Symbol	Min	Typ	Max	Unit
Output Voltage ( $T_J = +25^\circ\text{C}$ ) $I_O = 5.0\text{ mA}$ to $1.0\text{ A}$	$V_O$	17.3	18	18.7	Vdc
Line Regulation (Note 2) 21.5 to 33 Vdc 21 to 33 Vdc ( $T_J = +25^\circ\text{C}$ ) 24 to 30 Vdc, $I_O = 1.0\text{ A}$ 21 to 33 Vdc, $I_O = 1.0\text{ A}$ ( $T_J = +25^\circ\text{C}$ )	Regline	—	—	180 180 90 180	mV
Load Regulation (Note 2) 5.0 mA $\leq I_O \leq 1.0\text{ A}$ 5.0 mA $\leq I_O \leq 1.5\text{ A}$ ( $T_J = +25^\circ\text{C}$ ) 250 mA $\leq I_O \leq 750\text{ mA}$ ( $T_J = +25^\circ\text{C}$ )	Regload	—	—	180 180 90	mV
Output Voltage LM140 22 $\leq V_{in} \leq 33\text{ Vdc}$ , 5.0 mA $\leq I_O \leq 1.0\text{ A}$ , $P_D \leq 15\text{ W}$ LM340 21 $\leq V_{in} \leq 33\text{ Vdc}$ , 5.0 mA $\leq I_O \leq 1.0\text{ A}$ , $P_D \leq 15\text{ W}$	$V_O$	17.1	—	18.9	Vdc
Quiescent Current $I_O = 1.0\text{ A}$ LM140 LM340 LM140 ( $T_J = +25^\circ\text{C}$ ) LM340 ( $T_J = +25^\circ\text{C}$ )	$I_B$	—	—	7.0 8.5 6.0 8.0	mA
Quiescent Current Change 22 $\leq V_{in} \leq 33\text{ Vdc}$ , $I_O = 500\text{ mA}$ LM140 21 $\leq V_{in} \leq 33\text{ Vdc}$ , $I_O = 500\text{ mA}$ LM340 5.0 mA $\leq I_O \leq 1.0\text{ A}$ , $V_{in} = 27\text{ V}$ LM140, LM340 22 $\leq V_{in} \leq 33\text{ Vdc}$ , $I_O = 1.0\text{ A}$ LM140 21 $\leq V_{in} \leq 33\text{ Vdc}$ , $I_O = 1.0\text{ A}$ LM340	$\Delta I_B$	—	—	0.8 1.0 0.5 0.8 1.0	mA
Ripple Rejection LM140 LM340 $I_O = 1.0\text{ A}$ ( $T_J = +25^\circ\text{C}$ ) LM140 LM340	RR	59 53	— —	— —	dB
Dropout Voltage	$V_{in} - V_O$	—	1.7	—	Vdc
Output Resistance ( $f = 1.0\text{ kHz}$ )	$r_O$	—	2.0	—	m $\Omega$
Short Circuit Current Limit ( $T_J = +25^\circ\text{C}$ )	$I_{sc}$	—	500	—	mA
Output Noise Voltage ( $T_A = +25^\circ\text{C}$ ) 10 Hz $\leq f \leq 100\text{ kHz}$	$V_n$	—	110	—	$\mu\text{V}$
Average Temperature Coefficient of Output Voltage $I_O = 5.0\text{ mA}$	$TCV_O$	—	$\pm 2.3$	—	mV/ $^\circ\text{C}$
Peak Output Current ( $T_J = +25^\circ\text{C}$ )	$I_O$	—	2.4	—	A
Input Voltage to Maintain Line Regulation ( $T_J = +25^\circ\text{C}$ ) $I_O = 1.0\text{ A}$		21	—	—	Vdc

#### NOTES:

1.  $T_{low} = -55^\circ\text{C}$  for LM140       $T_{high} = +150^\circ\text{C}$  for LM140  
       =  $0^\circ\text{C}$  for LM340            =  $+125^\circ\text{C}$  for LM340

2. Load and line regulation are specified at constant junction temperature. Changes in  $V_O$  due to heating effects must be taken into account separately. Pulse testing with low duty cycle is used.

3

LM140/340 — 24

ELECTRICAL CHARACTERISTICS ( $V_{in} = 33\text{ V}$ ,  $I_O = 500\text{ mA}$ ,  $T_J = T_{low}$  to  $T_{high}$  (Note 1), unless otherwise noted).

Characteristic	Symbol	Min	Typ	Max	Unit
Output Voltage ( $T_J = +25^\circ\text{C}$ ) $I_O = 5.0\text{ mA}$ to $1.0\text{ A}$	$V_O$	23	24	25	Vdc
Line Regulation (Note 2) 28 to 38 Vdc 27 to 38 Vdc ( $T_J = +25^\circ\text{C}$ ) 30 to 36 Vdc, $I_O = 1.0\text{ A}$ 27.1 to 38 Vdc, $I_O = 1.0\text{ A}$ ( $T_J = +25^\circ\text{C}$ )	Regline	—	—	240	mV
Load Regulation (Note 2) $5.0\text{ mA} \leq I_O \leq 1.0\text{ A}$ $5.0\text{ mA} \leq I_O \leq 1.5\text{ A}$ ( $T_J = +25^\circ\text{C}$ ) $250\text{ mA} \leq I_O \leq 750\text{ mA}$ ( $T_J = +25^\circ\text{C}$ )	Regload	—	—	240	mV
Output Voltage LM140 $28 \leq V_{in} \leq 38\text{ Vdc}$ , $5.0\text{ mA} \leq I_O \leq 1.0\text{ A}$ , $P_D \leq 15\text{ W}$ LM340 $27 \leq V_{in} \leq 38\text{ Vdc}$ , $5.0\text{ mA} \leq I_O \leq 1.0\text{ A}$ , $P_D \leq 15\text{ W}$	$V_O$	22.8	—	25.2	Vdc
Quiescent Current $I_O = 1.0\text{ A}$ LM140 LM340 LM140 ( $T_J = +25^\circ\text{C}$ ) LM340 ( $T_J = +25^\circ\text{C}$ )	$I_B$	—	—	7.0	mA
Quiescent Current Change $28 \leq V_{in} \leq 38\text{ Vdc}$ , $I_O = 500\text{ mA}$ LM140 $27 \leq V_{in} \leq 38\text{ Vdc}$ , $I_O = 500\text{ mA}$ LM340 $5.0\text{ mA} \leq I_O \leq 1.0\text{ A}$ , $V_{in} = 33\text{ V}$ LM140, LM340 $28 \leq V_{in} \leq 38\text{ Vdc}$ , $I_O = 1.0\text{ A}$ LM140 $27.3 \leq V_{in} \leq 38\text{ Vdc}$ , $I_O = 1.0\text{ A}$ LM340	$\Delta I_B$	—	—	0.8	mA
Ripple Rejection LM140 LM340 $I_O = 1.0\text{ A}$ ( $T_J = +25^\circ\text{C}$ ) LM140 LM340	RR	56	—	—	dB
Dropout Voltage	$V_{in} - V_O$	—	1.7	—	Vdc
Output Resistance ( $f = 1.0\text{ kHz}$ )	$r_O$	—	2.0	—	$m\Omega$
Short Circuit Current Limit ( $T_J = +25^\circ\text{C}$ )	$I_{sc}$	—	200	—	mA
Output Noise Voltage ( $T_A = +25^\circ\text{C}$ ) $10\text{ Hz} \leq f \leq 100\text{ kHz}$	$V_n$	—	170	—	$\mu\text{V}$
Average Temperature Coefficient of Output Voltage $I_O = 5.0\text{ mA}$	$TCV_O$	—	$\pm 3.0$	—	$mV/^\circ\text{C}$
Peak Output Current ( $T_J = +25^\circ\text{C}$ )	$I_O$	—	2.4	—	A
Input Voltage to Maintain Line Regulation ( $T_J = +25^\circ\text{C}$ ) $I_O = 1.0\text{ A}$		27.1	—	—	Vdc

NOTES:

- $T_{low} = -55^\circ\text{C}$  for LM140       $T_{high} = +150^\circ\text{C}$  for LM140  
 $\quad \quad \quad = 0^\circ\text{C}$  for LM340       $\quad \quad \quad = +125^\circ\text{C}$  for LM340
- Load and line regulation are specified at constant junction temperature. Changes in  $V_O$  due to heating effects must be taken into account separately. Pulse testing with low duty cycle is used.

**VOLTAGE REGULATOR PERFORMANCE**

The performance of a voltage regulator is specified by its immunity to changes in load, input voltage, power dissipation, and temperature. Line and load regulation are tested with a pulse of short duration ( $< 100 \mu\text{s}$ ) and are strictly a function of electrical gain. However, pulse widths of longer duration ( $> 1.0 \text{ ms}$ ) are sufficient to affect temperature gradients across the die. These temperature gradients can cause a change in the output voltage, in addition to changes caused by line and load regulation. Longer pulse widths and thermal gradients make it desirable to specify thermal regulation.

Thermal regulation is defined as the change in output voltage caused by a change in dissipated power for a specified time, and is expressed as a percentage output voltage change per watt. The change in dissipated

power can be caused by a change in either the input voltage or the load current. Thermal regulation is a function of IC layout and die attach techniques, and usually occurs within 10 ms of a change in power dissipation. After 10 ms, additional changes in the output voltage are due to the temperature coefficient of the device.

Figure 1 shows the line and thermal regulation response of a typical LM140AK-5.0 to a 10 watt input pulse. The variation of the output voltage due to line regulation is labeled ① and the thermal regulation component is labeled ②. Figure 2 shows the load and thermal regulation response of a typical LM140AK-5.0 to a 15 watt load pulse. The output voltage variation due to load regulation is labeled ① and the thermal regulation component is labeled ②.

3

FIGURE 1 — LINE AND THERMAL REGULATION

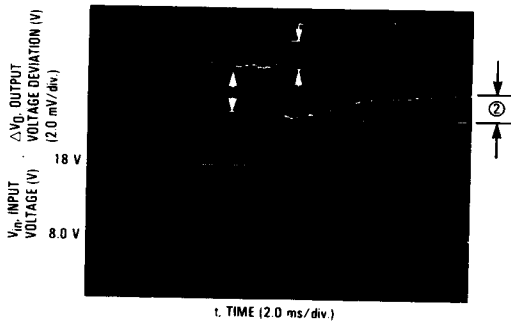

LM140AK-5.0  
 $V_O = 5.0 \text{ V}$   
 $V_{in} = 8.0 \text{ V} \rightarrow 18 \text{ V} \rightarrow 8.0 \text{ V}$  ① =  $\text{Reg}_{line} = 2.4 \text{ mV}$   
 $I_{out} = 1.0 \text{ A}$  ② =  $\text{Reg}_{therm} = 0.0030\%V_O/W$

FIGURE 2 — LOAD AND THERMAL REGULATION

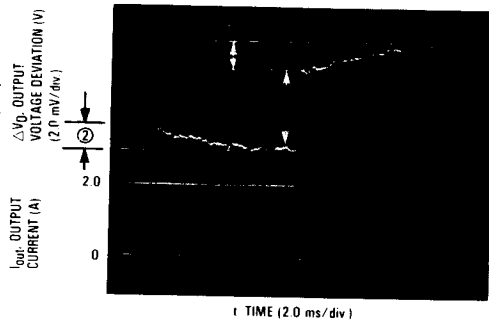

LM140AK-5.0  
 $V_O = 5.0 \text{ V}$   
 $V_{in} = 15$   
 $I_{out} = 0 \text{ A} \rightarrow 1.5 \text{ A} \rightarrow 0 \text{ A}$  ① =  $\text{Reg}_{load} = 4.4 \text{ mV}$   
 ② =  $\text{Reg}_{therm} = 0.0020\%V_O/W$

FIGURE 3 — TEMPERATURE STABILITY

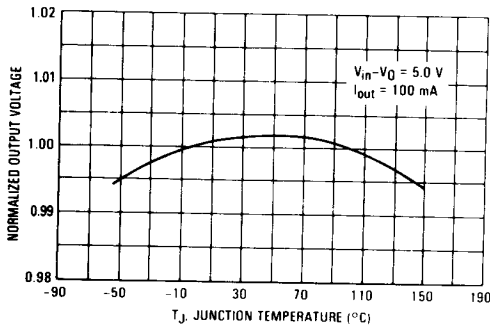
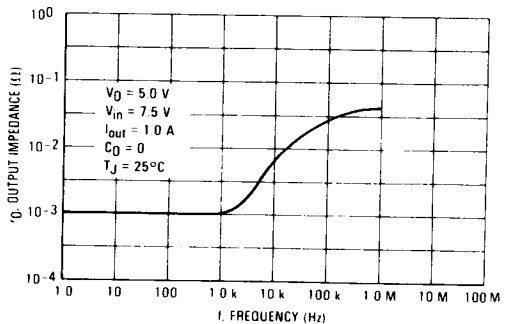

FIGURE 4 — OUTPUT IMPEDANCE



3

FIGURE 5 — RIPPLE REJECTION versus FREQUENCY

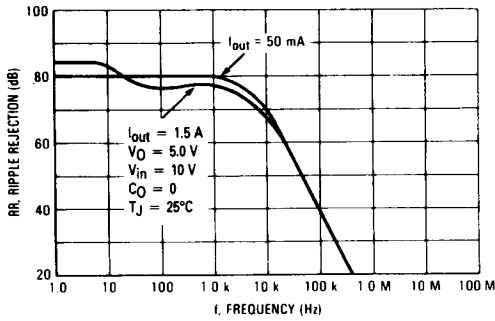

FIGURE 6 — RIPPLE REJECTION versus OUTPUT CURRENT

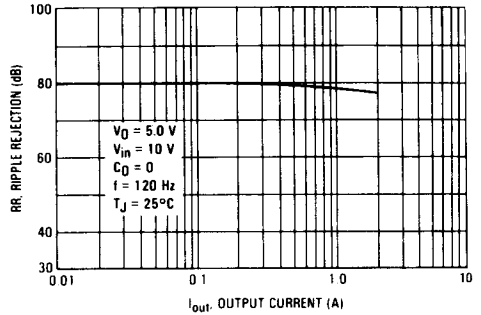

FIGURE 7 — QUIESCENT CURRENT versus INPUT VOLTAGE

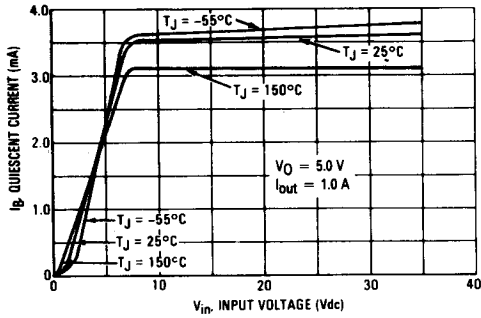

FIGURE 8 — QUIESCENT CURRENT versus OUTPUT CURRENT

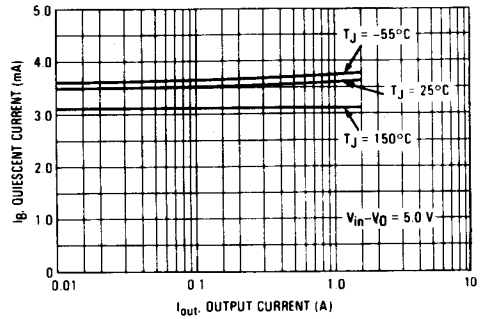

FIGURE 9 — DROPOUT VOLTAGE

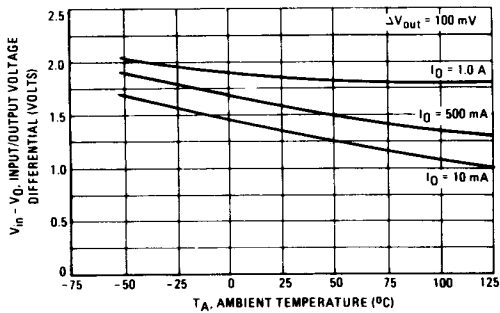

FIGURE 10 — PEAK OUTPUT CURRENT

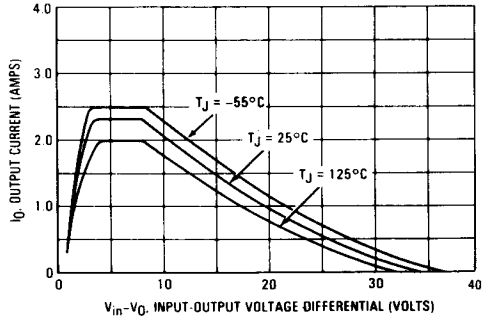

FIGURE 11 — LINE TRANSIENT RESPONSE

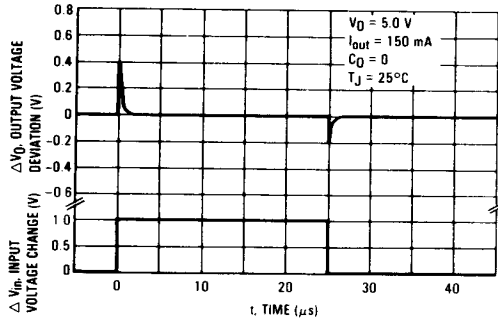

FIGURE 12 — LOAD TRANSIENT RESPONSE

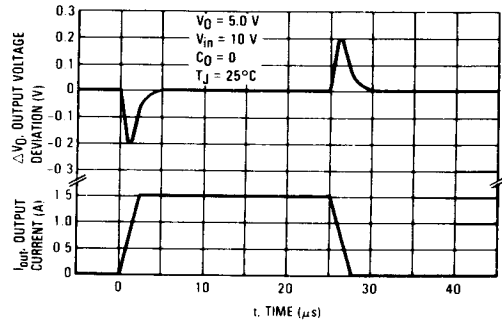

FIGURE 13 — WORST CASE POWER DISSIPATION versus AMBIENT TEMPERATURE (Case 221A)

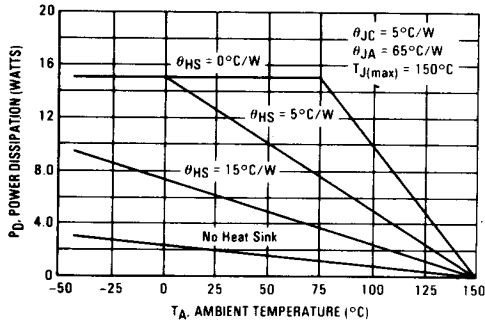
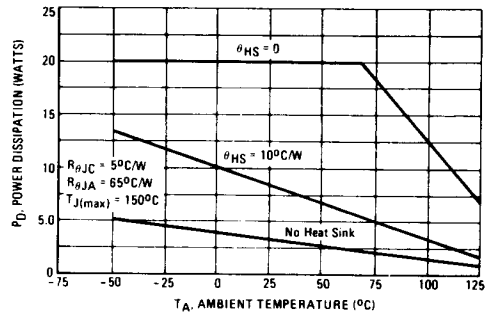

FIGURE 14 — WORST CASE POWER DISSIPATION versus AMBIENT TEMPERATURE (Case 1)



APPLICATIONS INFORMATION

Design Considerations

The LM140 Series of fixed voltage regulators are designed with Thermal Overload Protection that shuts down the circuit when subjected to an excessive power overload condition, Internal Short-Circuit Protection that limits the maximum current the circuit will pass, and Output Transistor Safe-Area Compensation that reduces the output short-circuit current as the voltage across the pass transistor is increased.

In many low current applications, compensation capacitors are not required. However, it is recommended that the regulator input be bypassed with a capacitor if the regulator is connected to the power supply filter

with long wire lengths, or if the output load capacitance is large. An input bypass capacitor should be selected to provide good high-frequency characteristics to insure stable operation under all load conditions. A 0.33  $\mu\text{F}$  or larger tantalum, mylar, or other capacitor having low internal impedance at high frequencies should be chosen. The bypass capacitor should be mounted with the shortest possible leads directly across the regulators input terminals. Normally good construction techniques should be used to minimize ground loops and lead resistance drops since the regulator has no external sense lead.

FIGURE 15 — CURRENT REGULATOR

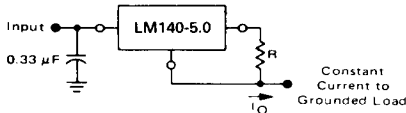

These regulators can also be used as a current source when connected as above. In order to minimize dissipation the LM140-5.0 is chosen in this application. Resistor R determines the current as follows:

$$I_O = \frac{5.0 \text{ V}}{R} + I_Q$$

$I_Q \cong 1.5 \text{ mA}$  over line and load changes

For example, a 1-ampere current source would require R to be a 5-ohm, 10-W resistor and the output voltage compliance would be the input voltage less 7.0 volts.

FIGURE 16 — ADJUSTABLE OUTPUT REGULATOR

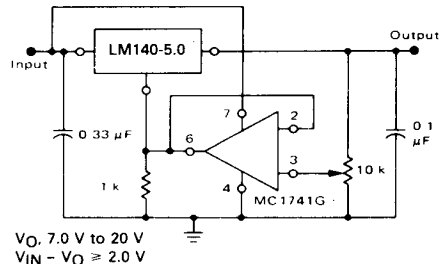

The addition of an operational amplifier allows adjustment to higher or intermediate values while retaining regulation characteristics. The minimum voltage obtainable with the arrangement is 2.0 volts greater than the regulator voltage.

FIGURE 17 — CURRENT BOOST REGULATOR

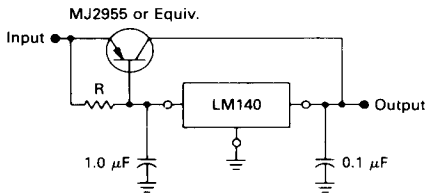

The LM140 series can be current boosted with a PNP transistor. The MJ2955 provides current to 5.0 amperes. Resistor R in conjunction with the  $V_{BE}$  of the PNP determines when the pass transistor begins conducting; this circuit is not short-circuit proof. Input-output differential voltage minimum is increased by  $V_{BE}$  of the pass transistor.

FIGURE 18 — SHORT-CIRCUIT PROTECTION

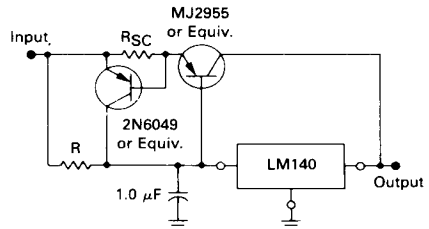

The circuit of Figure 17 can be modified to provide supply protection against short circuits by adding a short-circuit sense resistor,  $R_{SC}$ , and an additional PNP transistor. The current sensing PNP must be able to handle the short-circuit current of the three-terminal regulator. Therefore, a four-ampere plastic power transistor is specified.