

# TYPES SN74LS18, SN74LS19, SN74LS24 SCHMITT-TRIGGER POSITIVE-NAND GATES AND INVERTERS WITH TOTEM-POLE OUTPUTS

JANUARY 1981—REVISED DECEMBER 1983

- Functionally and Mechanically Identical To 'LS13, 'LS14, and 'LS132, Respectively
- Improved Line-Receiving Characteristics
- P-N-P Inputs Reduce System Loading
- Excellent Noise Immunity With Typical Hysteresis of 0.7 V

## description

Each circuit functions as a NAND gate or inverter, but because of the Schmitt action, it has different input threshold levels for positive ( $V_{T+}$ ) and for negative going ( $V_{T-}$ ) signals. The hysteresis or backlash, which is the difference between the two threshold levels ( $V_{T+} - V_{T-}$ ), is typically 900 millivolts.

These circuits are temperature-compensated and can be triggered from the slowest of input ramps and still give clean, jitter-free output signals.

## logic diagram (each gate or inverter)

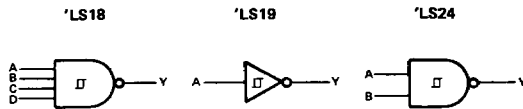

3

TTL DEVICES

SN74LS18 . . . D, J OR N PACKAGE  
(TOP VIEW)

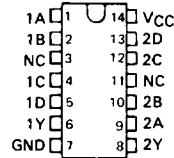

SN74LS18 . . . FN PACKAGE  
(TOP VIEW)

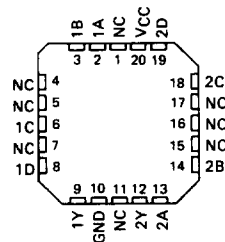

SN74LS19 . . . FN PACKAGE  
(TOP VIEW)

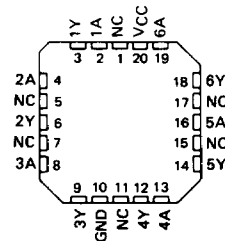

SN74LS24 . . . FN PACKAGE  
(TOP VIEW)

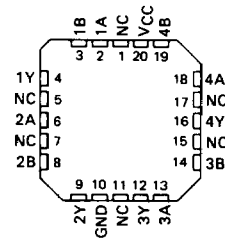

NC - No internal connection

SN74LS19 . . . D, J OR N PACKAGE  
(TOP VIEW)

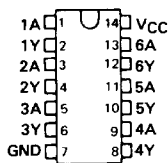

SN74LS24 . . . D, J OR N PACKAGE  
(TOP VIEW)

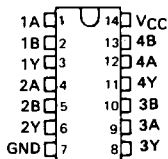

## PRODUCTION DATA

This document contains information current as of publication date. Products conform to specifications per the terms of Texas Instruments standard warranty. Production processing does not necessarily include testing of all parameters.

3-100

TEXAS  
INSTRUMENTS

POST OFFICE BOX 225012 • DALLAS, TEXAS 75265

# TYPES SN74LS18, SN74LS19, SN74LS24 SCHMITT-TRIGGER POSITIVE-NAND GATES AND INVERTERS WITH TOTEM-POLE OUTPUTS

schematic (each gate)

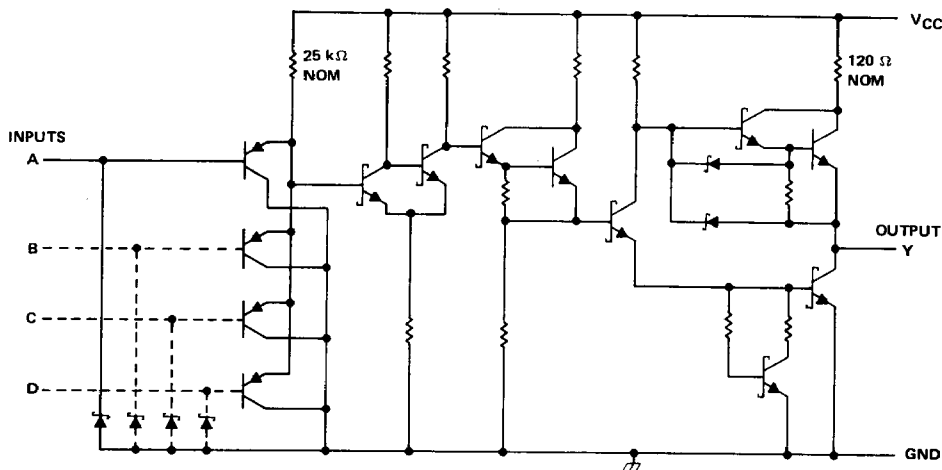

absolute maximum ratings over operating free-air temperature range (unless otherwise noted)

Supply voltage, $V_{CC}$ (see Note 1)	7 V
Input voltage	7 V
Operating free-air temperature range: SN74LS'	0°C to 70°C
Storage temperature range	-65°C to 150°C

**3**

recommended operating conditions

	SN74LS'			UNIT
	MIN	NOM	MAX	
Supply voltage, $V_{CC}$	4.75	5	5.25	V
High-level output current, $I_{OH}$			-400	$\mu$ A
Low-level output current, $I_{OL}$			8	mA
Operating free-air temperature, $T_A$	0	70		°C

TTL DEVICES

# TYPES SN74LS18, SN74LS19, SN74LS24 SCHMITT-TRIGGER POSITIVE-NAND GATES AND INVERTERS WITH TOTEM-POLE OUTPUTS

electrical characteristics over recommended operating free-air temperature range (unless otherwise noted)

PARAMETER	TEST CONDITIONS†		SN74LS*			UNIT	
			MIN	TYP‡	MAX		
$V_{T+}$	$V_{CC} = 5\text{ V}$		1.65	1.9	2.15	V	
$V_{T-}$	$V_{CC} = 5\text{ V}$		0.75	1.0	1.25	V	
Hysteresis ( $V_{T+} - V_{T-}$ )	$V_{CC} = 5\text{ V}$		0.4	0.9		V	
$V_{IK}$	$V_{CC} = \text{MIN.}$ , $I_I = -18\text{ mA}$				-1.5	V	
$V_{OH}$	$V_{CC} = \text{MIN.}$ , $V_I = V_{T-} - \text{min}$		$I_{OH} = -0.4\text{ mA}$		2.7	3.4	V
$V_{OL}$	$V_{CC} = \text{MIN.}$ , $V_I = V_{T+} + \text{max}$		$I_{OL} = 4\text{ mA}$		0.25	0.4	V
			$I_{OL} = 8\text{ mA}$		0.35	0.5	
$I_{T+}$	$V_{CC} = 5\text{ V.}$ , $V_I = V_{T+}$				-2	-20	$\mu\text{A}$
$I_{T-}$	$V_{CC} = 5\text{ V.}$ , $V_I = V_{T-}$				-5	-30	$\mu\text{A}$
$I_I$	$V_{CC} = \text{MAX.}$ , $V_I = 7\text{ V}$					0.1	mA
$I_{IH}$	$V_{CC} = \text{MAX.}$ , $V_I = 2.7\text{ V}$					20	$\mu\text{A}$
$I_{IL}$	$V_{CC} = \text{MAX.}$ , $V_I = 0.4\text{ V}$					-50	$\mu\text{A}$
$I_{OS}§$	$V_{CC} = \text{MAX.}$ , $V_I = V_O = 0\text{ V}$				-20	-100	mA
$I_{CCH}$	$V_{CC} = \text{MAX.}$ , $V_I = 0\text{ V}$		'LS18		3.3	6	mA
			'LS19		9.9	18	
			'LS24		6.6	12	
$I_{CCL}$	$V_{CC} = \text{MAX.}$ , $V_I = 4.5\text{ V}$		'LS18		5.7	10	mA
			'LS19		17	30	
			'LS24		11	20	

†For conditions shown as MIN or MAX, use the appropriate value specified under recommended operating conditions.

‡All typical values are at  $V_{CC} = 5\text{ V}$ ,  $T_A = 25^\circ\text{C}$ .

§Not more than one output should be shorted at a time, and the duration of the short-circuit should not exceed one second.

3

switching characteristics,  $V_{CC} = 5\text{ V}$ ,  $T_A = 25^\circ\text{C}$ , see figure 1

PARAMETER	FROM (INPUT)	TO (OUTPUT)	TEST CONDITIONS	'LS18		'LS19		'LS24		UNIT
				MIN	TYP	MAX	MIN	TYP	MAX	
$t_{PLH}$	Any	Y	$R_L = 2\text{ k}\Omega$ , $C_L = 15\text{ pF}$	13	20	13	20	13	20	ns
$t_{PHL}$	Any	Y		37	55	18	30	25	40	ns

$t_{PLH}$  = Propagation delay time, low-to-high-level output

$t_{PHL}$  = Propagation delay time, high-to-low-level output

TTL DEVICES

TYPES SN74LS18, SN74LS19, SN74LS24  
SCHMITT-TRIGGER POSITIVE-NAND GATES  
AND INVERTERS WITH TOTEM-POLE OUTPUTS

PARAMETER MEASUREMENT INFORMATION

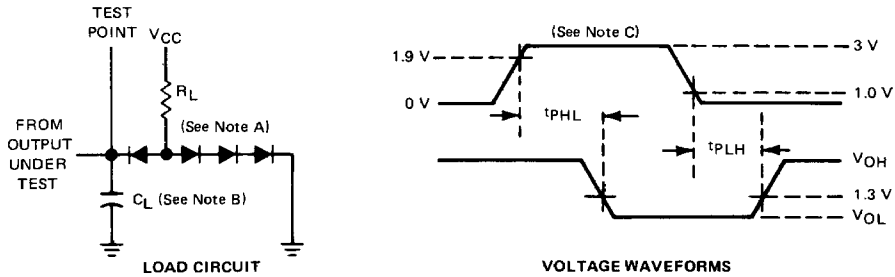

- NOTES: A. All diodes are IN3064 or equivalent.  
 B.  $C_L$  includes probe and circuit capacitance.  
 C. The generator characteristics are:  $P_{RR} = 1\text{MHz}$ ,  $t_r = 15\text{ ns}$ ,  
 $t_p = 6\text{ ns}$ ,  $Z_{out} = 50\ \Omega$ .

FIGURE 1