

MM74C Series CMOS

Functionally equivalent to Standard 74 Series
Pin compatible with Standard 74 Series.
Dissipation typically 10 nanowatts per gate

GENERAL DESCRIPTION

Employing complementary MOS (CMOS) transistors to achieve low power and high noise margin, these gates provide the basic functions used in the implementation of digital integrated circuit systems. The N and P channel enhancement mode transistors provide a symmetrical circuit with output swings essentially equal to the supply voltage. This results in high noise immunity over a wide supply voltage range. No DC power other than that caused by leakage current is consumed during static conditions. All inputs are protected against static discharge damage.

See outline drawings Nos. 109, 111 and 114 for physical dimensions.

FEATURES

Wide supply voltage range	3V to 15V
Guaranteed noise margin	1V
High noise immunity	0.45 V_{CC} typ
Lower power TTL compatible drives	2 x 74L loads

APPLICATIONS

Automotive
Instrumentation
Alarm systems
Remote metering.
Data terminals
Medical electronics
Industrial controls
Computers

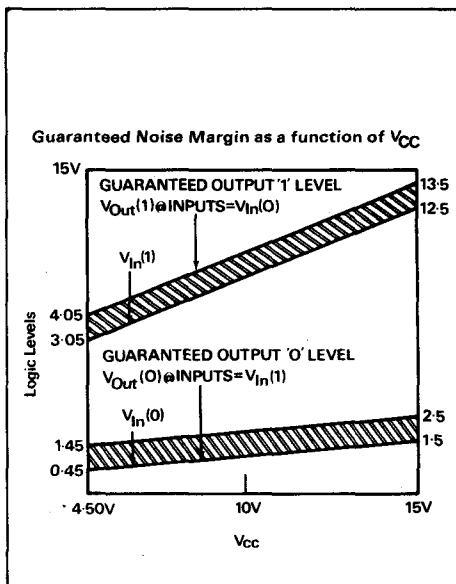
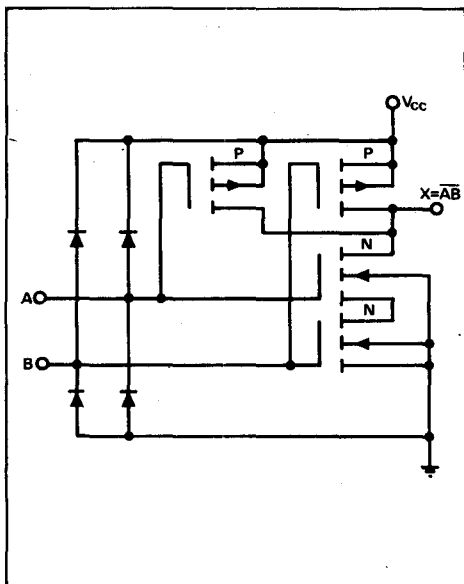

MANUFACTURER'S CURRENT LIST PRICES ARE ALWAYS CHARGED

TYPICAL GATE CHARACTERISTICS

Given below are details of a representative function (the MM74 COON)

ABSOLUTE MAXIMUM RATINGS

Voltage at Any Pin (Note 1)	-0.3V to +V _{CC} + 0.3V	Package Dissipation	500mW
Operating Temperature	0°C to +70°C	Lead Temperature (Soldering, 10 sec)	300°C
Storage Temperature	-65°C to +150°C	Operating V _{CC} Range	+3V to +15V

ELECTRICAL CHARACTERISTICS

Min./Max. limits apply across the guaranteed temperature range unless otherwise specified.

Parameter	Conditions	Min.	Typ.	Max.	Units
CMOS to CMOS					
Logical "1" Input Voltage V _{IN} (1)	V _{CC} = 5.0V V _{CC} = 10.0V	3.5 8.0			V
Logical "0" Input Voltage V _{IN} (0)	V _{CC} = 5.0V V _{CC} = 10.0V		1.5 2.0		V
Logical "1" Output Voltage V _{OUT} (1)	V _{CC} = 5.0V, V _{IN} = 1.5, I _O = -10 μA V _{CC} = 10.0V, V _{IN} = 7.0, I _O = -10 μA	4.5 9.0			V
Logical "0" Output Voltage V _{OUT} (0)	V _{CC} = 5.0V, V _{IN} = 3.5, I _O = 10 μA V _{CC} = 10.0V, V _{IN} = 8.0, I _O = 10 μA			0.5 1.0	V
Logical "1" Input Current I _{IN} (1)	V _{CC} = 15V, V _{IN} = 15V			1	μA
Logical "0" Input Current I _{IN} (0)	V _{CC} = 15V, V _{IN} = 0V	-1			μA
Output Short Circuit Current I _{OS} (1) (Note 2)	V _{CC} = 5.5V, V _{IN} = 0, V _O = 0 V _{CC} = 11.0V, V _{IN} = 0, V _O = 0	1 7.5		6 30	mA
Output Short Circuit Current I _{OS} (0) (Note 2)	V _{CC} = 5.5V, V _{IN} = V _O = V _{CC} V _{CC} = 11.0V, V _{IN} = V _O = V _{CC}	1.5 10		10 40	mA
Supply Current I _{CC}	V _{CC} = 15V			1	μA
Propagation Delay Time to a Logical "0" t _{pd0}	V _{CC} = 5.0V, C _L = 50 pF, T _A = 25°C V _{CC} = 10.0V, C _L = 50 pF, T _A = 25°C		50 25	90 60	ns
Propagation Delay Time to a Logical "1" t _{pd1}	V _{CC} = 5.0V, C _L = 50 pF, T _A = 25°C V _{CC} = 10.0V, C _L = 50 pF, T _A = 25°C		50 30	90 60	ns
LOW POWER TTL to CMOS					
Logical "1" Input Voltage V _{IN} (1)	V _{CC} = 4.75V	V _{CC} - 1.5			V
Logical "0" Input Voltage V _{IN} (0)	V _{CC} = 4.75V			0.8	V
Logical "1" Output Voltage V _{OUT} (1)	V _{CC} = 4.75V, I _O = -10 μA	4.4			V
Logical "0" Output Voltage V _{OUT} (0)	V _{CC} = 4.75V, I _O = 10 μA			0.8	V
Propagation Delay Time to a Logical "0" t _{pd(0)}	V _{CC} = 5.0V, C _L = 15 pF, T _A = 25°C		125		ns
Propagation Delay Time to a Logical "1" t _{pd(1)}	V _{CC} = 5.0V, C _L = 15 pF, T _A = 25°C		125		ns
CMOS to Low Power TTL (tenth power)					
Logical "1" Input Voltage V _{IN} (1)	V _{CC} = 4.75V	4.0			V
Logical "0" Input Voltage V _{IN} (0)	V _{CC} = 4.75V			1.0	V
Logical "1" Output Voltage V _{OUT} (1)	V _{CC} = 4.75V, V _{IN} = 0.8, I _O = -100 μA	2.4			V
Logical "0" Output Voltage V _{OUT} (0)	V _{CC} = 4.75V, V _{IN} = 4.0, I _O = 360 μA			0.4	V
Propagation Time to a Logical "0" t _{pd(0)}	V _{CC} = 5.0V, C _L = 50 pF, R _L = 20k, T _A = 25°C		60		ns
Propagation Time to a Logical "1" t _{pd(1)}	V _{CC} = 5.0V, C _L = 50 pF, R _L = 20k, T _A = 25°C		45		ns

Note 1: These devices should not be connected under power on conditions.

Note 2: Only one output at a time may be shorted.

Continued on next page

switching time waveforms and ac test circuits

CMOS to CMOS

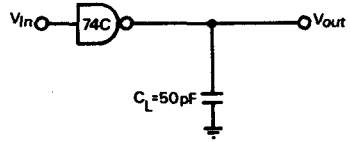
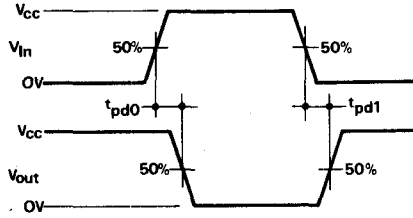

TTL to CMOS

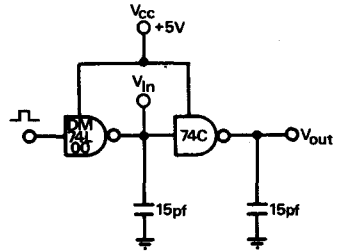
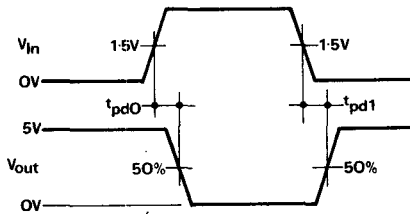

CMOS to low power TTL

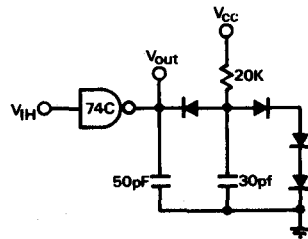
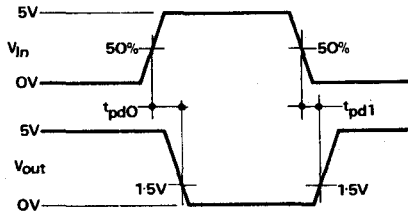

MANUFACTURER'S CURRENT LIST PRICES ARE ALWAYS CHARGED

MM74C Series CMOS

REFERENCE TABLE. See outline drawings Nos. 109, 111 and 114 for physical dimensions.

Code	Function	Stock No.	Connection Diagram No.
MM74C00N	Quad 2-input NAND Gate	33233R	B1
MM74C02N	Quad 2-input NOR Gate	33234G	B3
MM74C04N	Hex Inverter	33235E	B5
MM74C08N	Quad 2-input AND Gate	34685C	B9
MM74C10N	Triple 3-input NAND Gate	33236C	B11
MM74C20N	Dual 4-input NAND Gate	33237A	B19
MM74C30N	8-input NAND Gate	34686A	B26
MM74C42N	BCD-To-Decimal Decoder	33238X	B33
MM74C73N	Dual J-K Master-Slave Flip-Flop	33239H	B54
MM74C74N	Dual "D" Flip-Flop	33240X	B55
MM74C76N	Dual J-K Master-Slave Flip-Flop	33241R	B57
MM74C83N	4-Bit Binary Full Adder	34687X	B62
MM74C85N	4-Bit Magnitude Comparator	34688H	B64
MM74C86N	Quad 2-input EXCLUSIVE-OR Gate	34689F	B65
MM74C89N	64-Bit TRI-STATE random access read/write memory	34690R	B67
MM74C95N	4-Bit Parallel-In/Parallel-Out Shift Register	33242G	B73
MM74C107N	Dual J-K Master-Slave Flip-Flop	33243E	B80
MM74C123N	Retriggerable Monostable Multivibrator	33244C	B89
MM74C151N	8-Bit Data Selections/MUX with Strobe	33245A	B103
MM74C154N	4 to 16 Line Decoder Demultiplexer	33246X	B106
MM74C157N	Quad 2 Line to 1 Line Multiplexer	33419X	B109
MM74C160N	Synchronous Decade Counter	33247H	B111
MM74C161N	Synchronous 4-Bit Binary Counter	33248F	B112
MM74C162N	Fully Synchronous Decade Counter	33249D	B113
MM74C163N	Fully Synchronous 4-Bit Binary Counter	33250G	B114
MM74C164N	8-Bit Parallel-Out Shift Register	33251E	B115
MM74C165N	Parallel-Load 8-Bit Shift Register	33252C	B116
MM74C173N	Quad Latch	33254X	B120
MM74C174N	Hex D Flip-Flop	34691G	B121
MM74C192N	Synchronous Up/Down Decade Counter	33255H	B134
MM74C193N	Synchronous Up/Down 4-Bit Binary Counter	33256F	B135
MM74C195N	4-Bit Parallel-Access Shift Register	33257D	B137
*MM74C200N	256-BIT RAM	33258B	B142

*NOTE: These are new products—check on availability with our sales desk.

PLEASE QUOTE STOCK NO. AND MANUFACTURER'S CODE WHEN ORDERING

B61 SN7482N
2-bit binary full adder

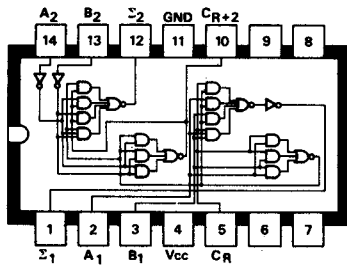

B64 SN7485N
4-bit comparator

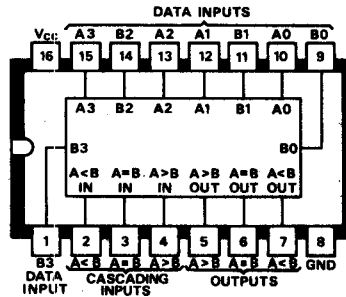

B62 SN7483N
4-bit binary full adder

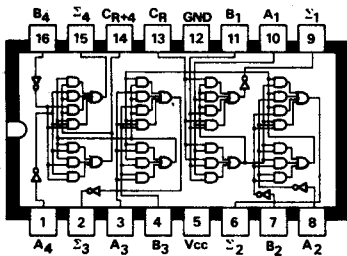

B65 SN7486N
SN74S86N
Quad 2-input
exclusive-OR element

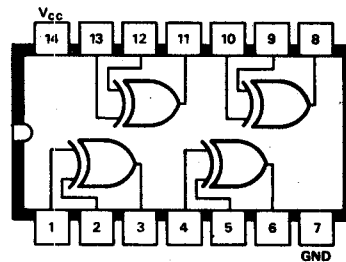

B63 SN7484N
16-bit read/write memory

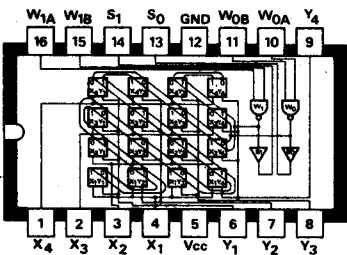

B66 SN7488N/AN
256-bit ROM (32 x 8)

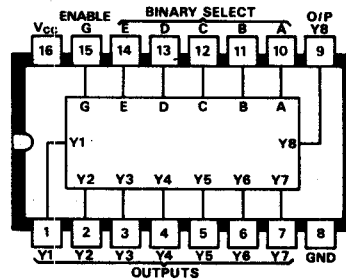

7