

μA747 Dual Operational Amplifier

Linear Division Operational Amplifiers

Description

The μA747 contains a pair of high performance monolithic operational amplifiers constructed using the Fairchild Planar Epitaxial process. They are intended for a wide range of analog applications where board space or weight are important. High common mode voltage range and absence of latch up make the μA747 ideal for use as a voltage follower. The high gain and wide range of operating voltage provide superior performance in integrator, summing amplifier, and general feedback applications. The μA747 is short circuit protected and requires no external components for frequency compensation. The internal 6 dB/octave roll-off insures stability in closed loop applications. For single amplifier performance, see μA741 data sheet.

- No Frequency Compensation Required
- Short Circuit Protection
- Offset Voltage Null Capability
- Large Common Mode And Differential Voltage Ranges
- Low Power Consumption
- No Latch Up

Absolute Maximum Ratings

Storage Temperature Range	
Metal Can and Ceramic DIP	-65°C to +175°C
Molded DIP and SO-14	-65°C to +150°C
Operating Temperature Range	
Extended (μA747AM, μA747M)	-55°C to +125°C
Commercial (μA747EC, μA747C)	0°C to +70°C
Lead Temperature	
Metal Can and Ceramic DIP (soldering, 60 s)	300°C
Molded DIP and SO-14 (soldering, 10 s)	265°C
Internal Power Dissipation ^{1, 2}	
10L-Metal Can	1.07 W
14L-Ceramic DIP	1.36 W
14L-Molded DIP	1.04 W
SO-14	0.93 W
Supply Voltage	
μA747A, μA747	± 22 V
μA747E, μA747C	± 18 V
Differential Input Voltage	± 30 V
Input Voltage ³	± 15 V
Voltage Between Offset Null and V-	± 0.5 V
Output Short Circuit Duration ⁴	Indefinite

Notes

1. T_J Max = 150°C for the Molded DIP and SO-14, and 175°C for the Metal Can Ceramic DIP.
2. Ratings apply to ambient temperature at 25°C. Above this temperature, derate the 10L-Metal Can at 7.1 mW/°C, the 14L-Ceramic DIP at 9.1 mW/°C, the 14L-Molded DIP at 8.3 mW/°C, and the SO-14 at 7.5 mW/°C.
3. For supply voltages less than ± 15 V, the absolute maximum input voltage is equal to the supply voltage.

Connection Diagram 10-Lead Metal Package (Top View)

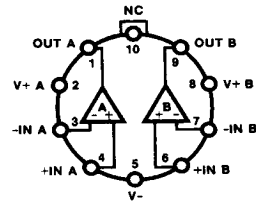

CD00771F

Lead 5 connected to case.

Order Information

Device Code	Package Code	Package Description
μA747HM	5X	Metal
μA747HC	5X	Metal
μA747AHM	5X	Metal
μA747EHC	5X	Metal

Connection Diagram 14-Lead DIP and SO-14 Package (Top View)

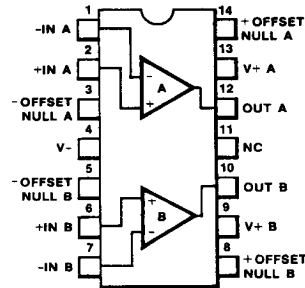

CD00761F

Order Information

Device Code	Package Code	Package Description
μA747DM	6A	Ceramic DIP
μA747DC	6A	Ceramic DIP
μA747PC	9A	Molded DIP
μA747SC	KD	Molded Surface Mount
μA747ADM	6A	Ceramic DIP
μA747EDC	6A	Ceramic DIP

4. Short circuit may be to ground or either supply. Rating applies to 125°C case temperature or 75°C ambient temperature.

Equivalent Circuit (1/2 of circuit)

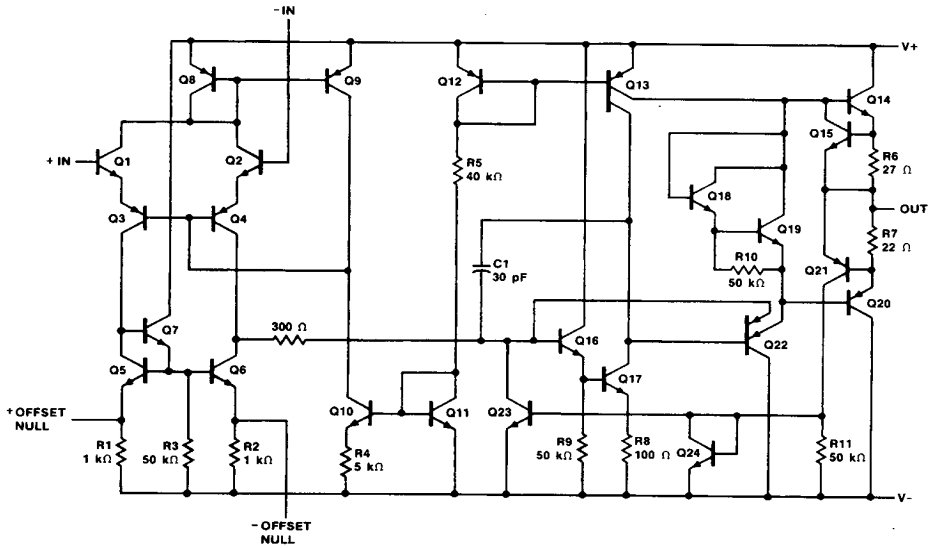

BD00351F

V+A is internally connected to V + B.

μA747

μA747 and μA747C

Electrical Characteristics $T_A = 25^\circ\text{C}$, $V_{CC} = \pm 15\text{ V}$, unless otherwise specified.

Symbol	Characteristic	Condition	μA747			μA747C			Unit
			Min	Typ	Max	Min	Typ	Max	
V_{IO}	Input Offset Voltage	$R_S \leq 10\text{ k}\Omega$		1.0	5.0		1.0	6.0	mV
$V_{IO\text{ adj}}$	Input Offset Voltage Adjustment Range			± 15			± 15		mV
I_{IO}	Input Offset Current			20	200		20	200	nA
I_{IB}	Input Bias Current			80	500		80	500	nA
Z_I	Input Impedance		0.3	2.0		0.3	2.0		MΩ
I_{CC}	Supply Current			3.4	5.6		3.9	5.6	mA
P_c	Power Consumption			100	170		100	170	mW
PSRR	Power Supply Rejection Ratio			30	150				μV/V
		$V_{CC} = \pm 5.0\text{ V to } \pm 18\text{ V}$					30	150	
I_{OS}	Output Short Circuit Current			25			25		mA
A_{VS}	Large Signal Voltage Gain	$R_L \geq 2.0\text{ k}\Omega$, $V_O = \pm 10\text{ V}$	50	200		25	200		V/mV
TR	Transient Response	Rise time Overshoot	$V_I = 50\text{ mV}$, $R_L = 2.0\text{ k}\Omega$, $C_L = 100\text{ pF}$, $A_V = 1.0$		0.3		0.3		μs
					5.0		5.0		%
BW	Bandwidth			1.0			1.0		MHz
SR	Slew Rate	$R_L = 2.0\text{ k}\Omega$, $A_V = 1.0$		0.5			0.5		V/μs
CS	Channel Separation			120			120		dB

The following specifications apply over the range of $-55^\circ\text{C} \leq T_A \leq +125^\circ\text{C}$ for μA747, $0^\circ\text{C} \leq T_A \leq 70^\circ\text{C}$ for μA747C

V_{IO}	Input Offset Voltage	$R_S \leq 10\text{ k}\Omega$		1.0	6.0		1.0	7.5	mV
I_{IO}	Input Offset Current	$0^\circ\text{C} \leq T_A \leq 70^\circ\text{C}$					7.0	300	nA
		$T_A = +125^\circ\text{C}$		7.0	200				
		$T_A = -55^\circ\text{C}$		85	500				
I_{IB}	Input Bias Current	$0^\circ\text{C} \leq T_A \leq 70^\circ\text{C}$					30	800	nA
		$T_A = +125^\circ\text{C}$		0.03	0.5				μA
		$T_A = -55^\circ\text{C}$		0.3	1.5				
I_{CC}	Supply Current	$0^\circ\text{C} \leq T_A \leq 70^\circ\text{C}$					4.0	6.6	mA
		$T_A = +125^\circ\text{C}$		3.0	5.0				
		$T_A = -55^\circ\text{C}$		4.0	6.6				
P_c	Power Consumption	$0^\circ\text{C} \leq T_A \leq 70^\circ\text{C}$					120	200	mW
		$T_A = +125^\circ\text{C}$		90	150				
		$T_A = -55^\circ\text{C}$		120	200				
CMR	Common Mode Rejection	$R_S \leq 10\text{ k}\Omega$	70	90		70	90		dB
V_{IR}	Input Voltage Range		± 12	± 13		± 12	± 13		V
PSRR	Power Supply Rejection Ratio			30	150				μV/V
		$V_{CC} = \pm 5.0\text{ V to } \pm 18\text{ V}$					30	150	
A_{VS}	Large Signal Voltage Gain	$R_L \geq 2.0\text{ k}\Omega$, $V_O = \pm 10\text{ V}$	25			15			V/mV
V_{OP}	Output Voltage Swing	$R_L = 10\text{ k}\Omega$	± 12	± 14		± 12	± 14		V
		$R_L = 2.0\text{ k}\Omega$	± 10	± 13		± 10	± 13		

μA747

μA747A and μA747E

Electrical Characteristics $T_A = 25^\circ\text{C}$, $\pm 5.0 \text{ V} \leq V_{CC} \leq \pm 20 \text{ V}$, unless otherwise specified.

Symbol	Characteristic	Condition	Min	Typ	Max	Unit
V_{IO}	Input Offset Voltage	$R_S \leq 50 \Omega$		0.8	3.0	mV
$V_{IO \text{ adj}}$	Input Offset Voltage Adjustment Range	$V_{CC} = \pm 20 \text{ V}$	10			mV
I_{IO}	Input Offset Current			3.0	30	nA
I_{IB}	Input Bias Current			30	80	nA
Z_I	Input Impedance	$V_{CC} = \pm 20 \text{ V}$	1.0	6.0		MΩ
P_c	Power Consumption	$V_{CC} = \pm 20 \text{ V}$		160	300	mW
CMR	Common Mode Rejection	$V_{CC} = \pm 20 \text{ V}$, $V_I = \pm 15 \text{ V}$, $R_S = 50 \Omega$	80	95		dB
PSRR	Power Supply Rejection Ratio	$V_{CC} = +10 \text{ V}$, -20 V to $V_{CC} = +20 \text{ V}$, -10 V , $R_S = 50 \Omega$		15	50	μV/V
I_{OS}	Output Short Circuit Current	μA747A	10	25	40	mA
		μA747E	10	25	35	
A_{VS}	Large Signal Voltage Gain	$V_{CC} = \pm 20 \text{ V}$, $R_L \geq 2.0 \text{ k}\Omega$, $V_O = \pm 15 \text{ V}$	50			V/mV
TR	Transient Response	Rise time Overshoot	$V_I = 50 \text{ mV}$, $R_L = 2.0 \text{ k}\Omega$, $C_L = 100 \text{ pF}$ $A_V = 1.0$	0.25	0.8	μs
					6.0	20
BW	Bandwidth		0.437	1.5		MHz
SR	Slew Rate	$V_I = \pm 10 \text{ V}$, $A_V = 1$	0.3	0.7		V/μs
The following specifications apply over the range of $-55^\circ\text{C} \leq T_A \leq +125^\circ\text{C}$ for μA747A, $0^\circ\text{C} \leq T_A \leq +70^\circ\text{C}$ for μA747E.						
V_{IO}	Input Offset Voltage				4.0	mV
$\Delta V_{IO}/\Delta T$	Input Offset Voltage Temperature Sensitivity				15	μV/°C
I_{IO}	Input Offset Current				70	nA
I_{IB}	Input Bias Current				210	nA
$\Delta I_{IO}/\Delta T$	Input Offset Current Temperature Sensitivity	μA747E	$T_A = 25^\circ\text{C}$ to 70°C		0.2	nA/°C
			$T_A = 0^\circ\text{C}$ to 25°C		0.5	
		μA747A	$T_A = 25^\circ\text{C}$ to 125°C		0.2	
			$T_A = -55^\circ\text{C}$ to $+25^\circ\text{C}$		0.5	
Z_I	Input Impedance	$V_{CC} = \pm 20 \text{ V}$	0.5			MΩ
P_c	Power Consumption	$V_{CC} = \pm 20 \text{ V}$	μA747A	-55°C	330	mW
				+125°C	270	
			μA747E		330	
I_{OS}	Output Short Circuit Current		10		40	mA
A_{VS}	Large Signal Voltage Gain	$V_{CC} = \pm 20 \text{ V}$, $R_L \geq 2.0 \text{ k}\Omega$, $V_O = \pm 15 \text{ V}$	32			V/mV
		$V_{CC} = \pm 5 \text{ V}$, $R_L \geq 2.0 \text{ k}\Omega$, $V_O = \pm 2.0 \text{ V}$	10			
V_{OP}	Output Voltage Swing	$V_{CC} = \pm 20 \text{ V}$	$R_L = 10 \text{ k}\Omega$	±16		V
			$R_L = 2.0 \text{ k}\Omega$	±15		
CS	Channel Separation	$V_{CC} = \pm 20 \text{ V}$	100			dB

Typical Performance Curves for $\mu A747A$ and $\mu A747$

Input Bias Current vs Temperature

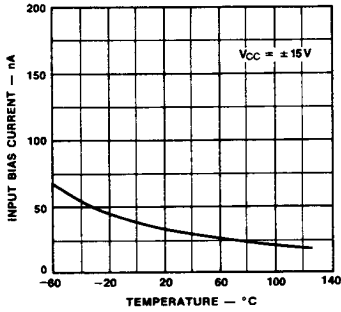

PC05510F

Input Impedance vs Temperature

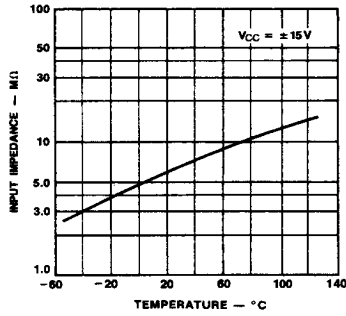

PC05521F

Short Circuit Current vs Temperature

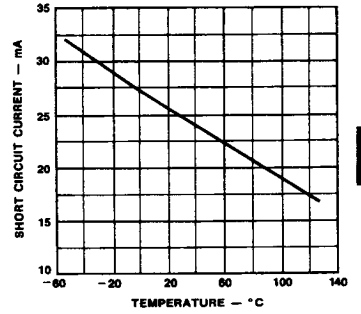

PC05531F

Input Offset Current vs Temperature

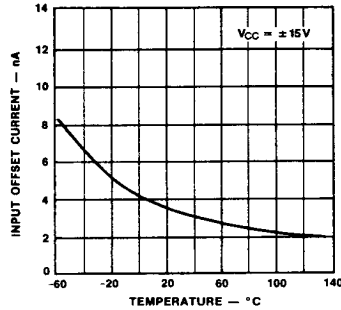

PC05540F

Power Consumption vs Temperature

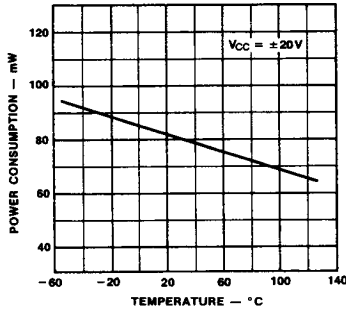

PC05550F

Frequency Characteristics vs Temperature

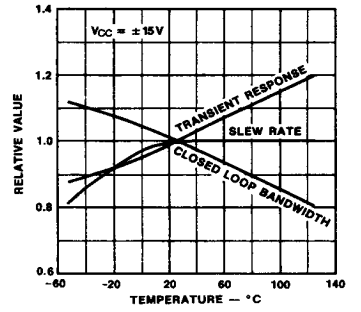

PC05560F

Input Bias Current vs Temperature For $\mu A747C/E$

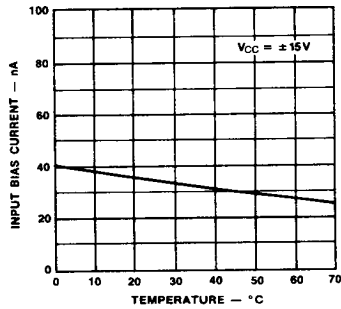

PC05570F

Input Impedance vs Temperature For $\mu A747C/E$

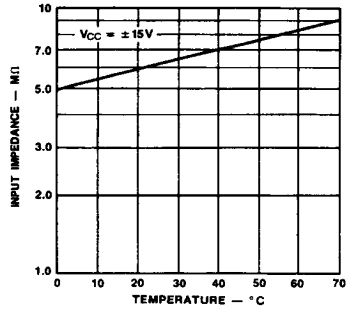

PC05581F

Input Offset Current vs Temperature For $\mu A747C/E$

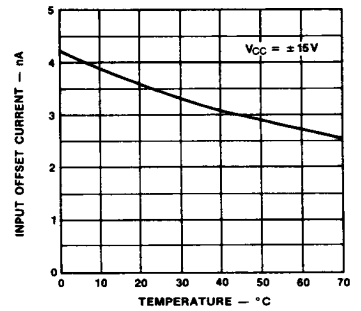

PC05590F

Typical Performance Curves (Cont.)

Power Consumption vs Temperature For $\mu A747C/E$

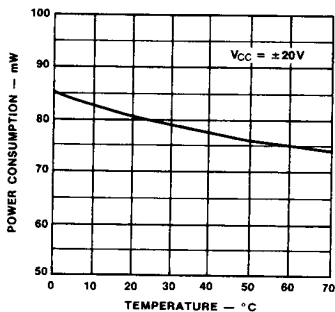

Short Circuit Current vs Temperature For $\mu A747C/E$

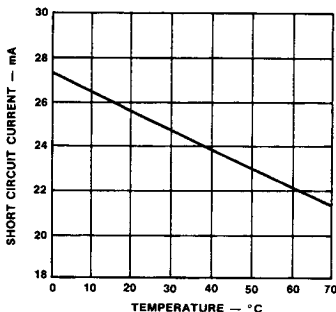

Frequency Characteristics vs Temperature For $\mu A747C/E$

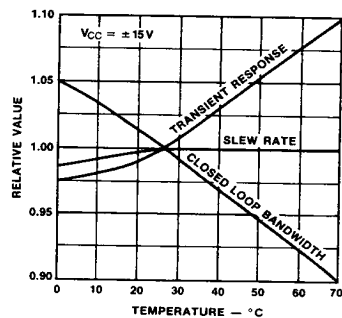

Power Consumption vs Supply Voltage

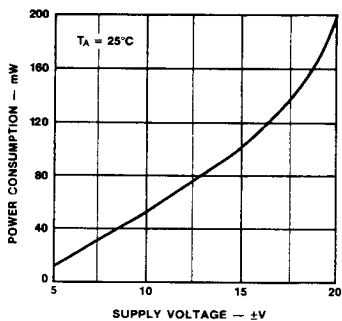

Open Loop Frequency Response

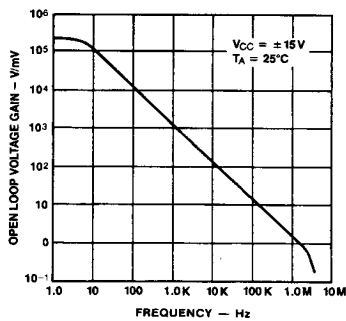

Open Loop Phase Response vs Frequency

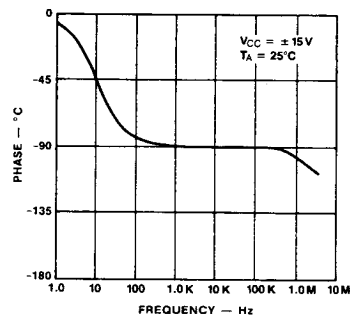

Input Offset Current vs Supply Voltage

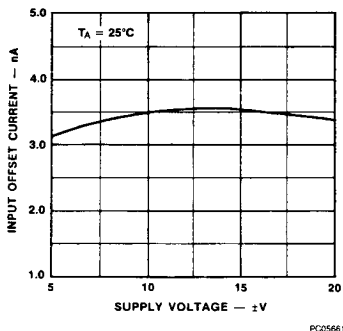

Input Impedance and Input Capacitance vs Frequency

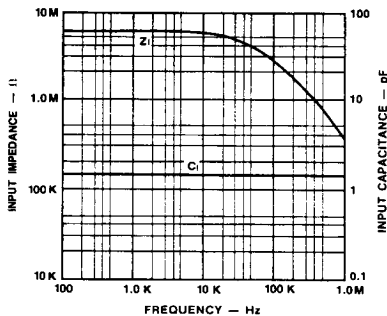

Output Resistance vs Frequency

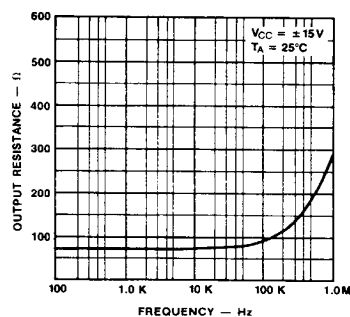

Typical Performance Curves (Cont.)

Output Voltage Swing vs Load Resistance

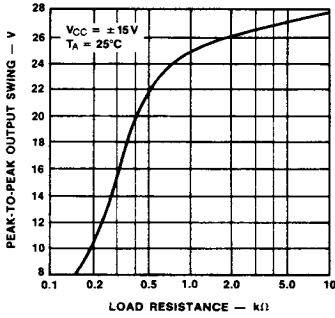

PC05600F

Output Voltage Swing vs Frequency

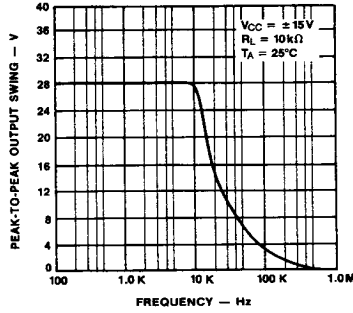

PC05701F

Input Noise Voltage Density vs Frequency

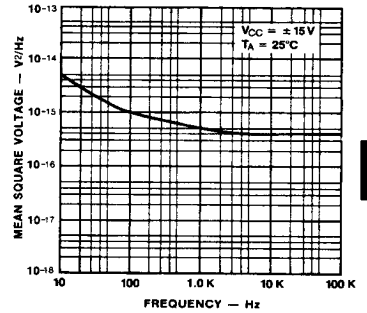

PC05711F

Input Noise Current Density vs Frequency

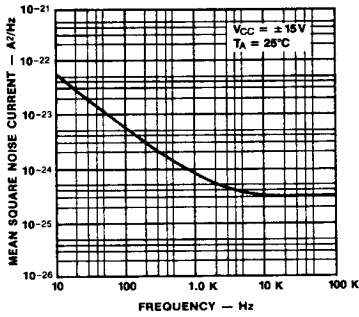

PC05721F

Broadband Noise for Various Bandwidths

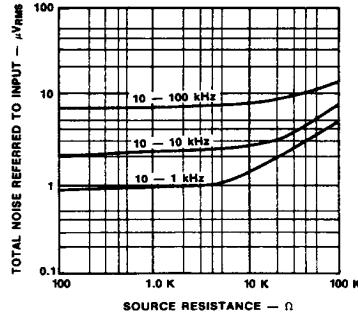

PC05731F

Common Mode Rejection Ratio vs and Frequency $\mu A747/C$

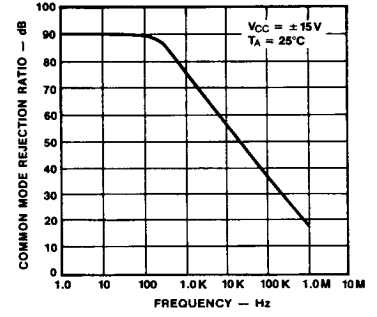

PC05741F

Transient Response For $\mu A747/C$

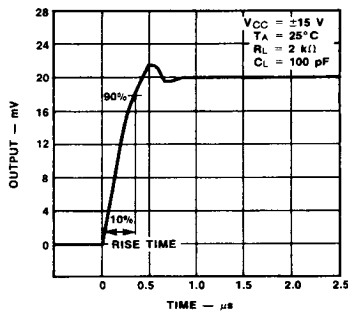

PC05751F

Voltage Follower Large Signal Pulse Response For $\mu A747/C$

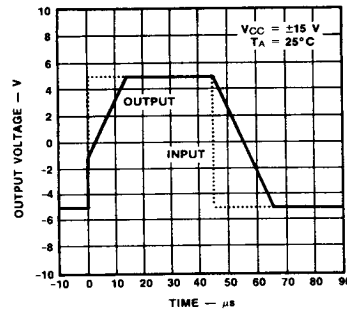

PC05760F

Frequency Characteristics vs Supply Voltage For $\mu A747/C$

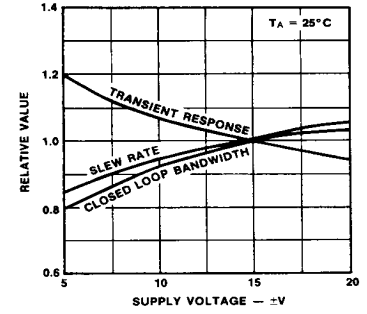

PC05770F

Test Circuits

Voltage Offset Null Circuit

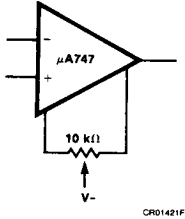

Transient Response Test Circuit

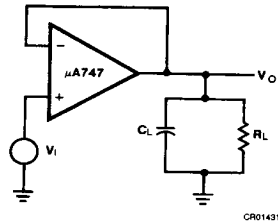

Typical Applications

Quadrature Oscillator

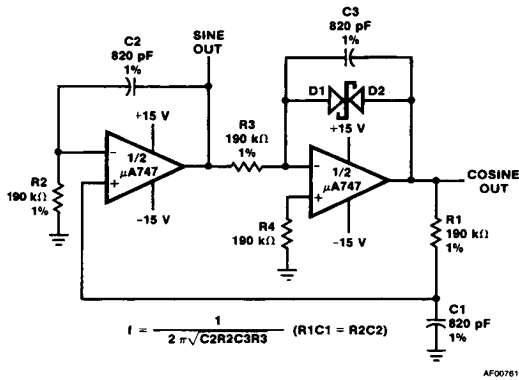

Tracking Positive and Negative Voltage References

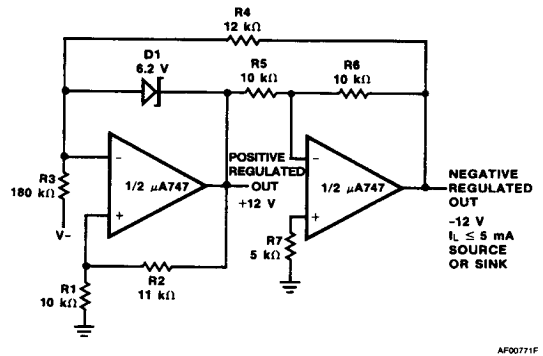

$$\text{Positive Output} = V_{D1} \times \frac{R1 + R2}{R2}$$

$$\text{Negative Output} = -\text{Positive Output} \times \frac{R6}{R5}$$

Analog Multiplier

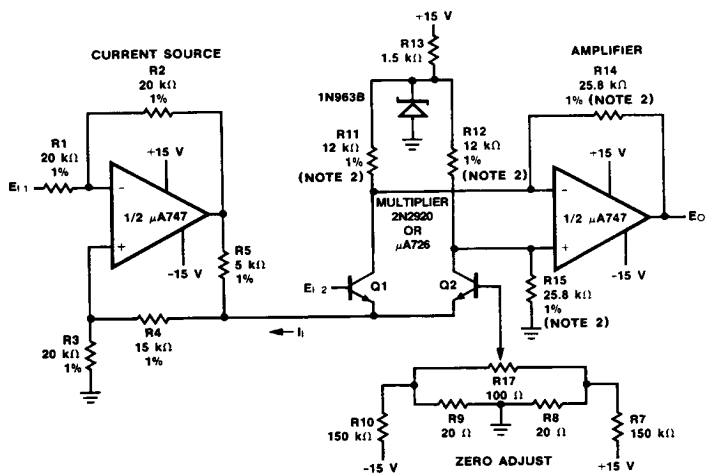

AF00791F

7

Compressor/Expander Amplifiers (Note 1)

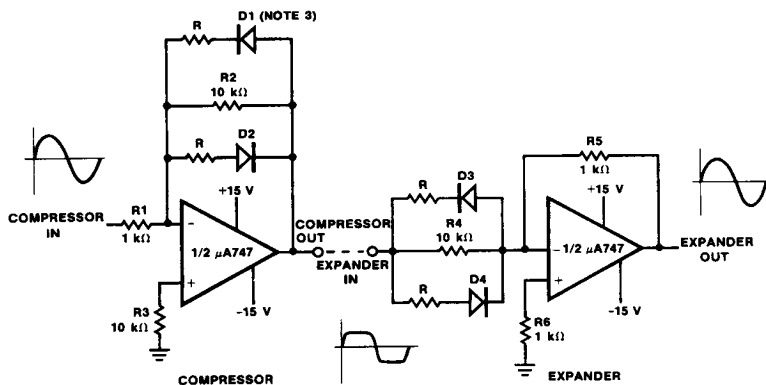

AF00791F

Notes

1. Maximum Compression Expansion Ratio = R/R ($10 \text{ k}\Omega > R \geq 0$)
2. Matched to 0.1% $E_O = 100 E_{i1} \times E_{i2}$
3. Diodes $D1$ through $D4$ are matched FD666 or Equivalent