

VARIABLE TRANSFORMERS

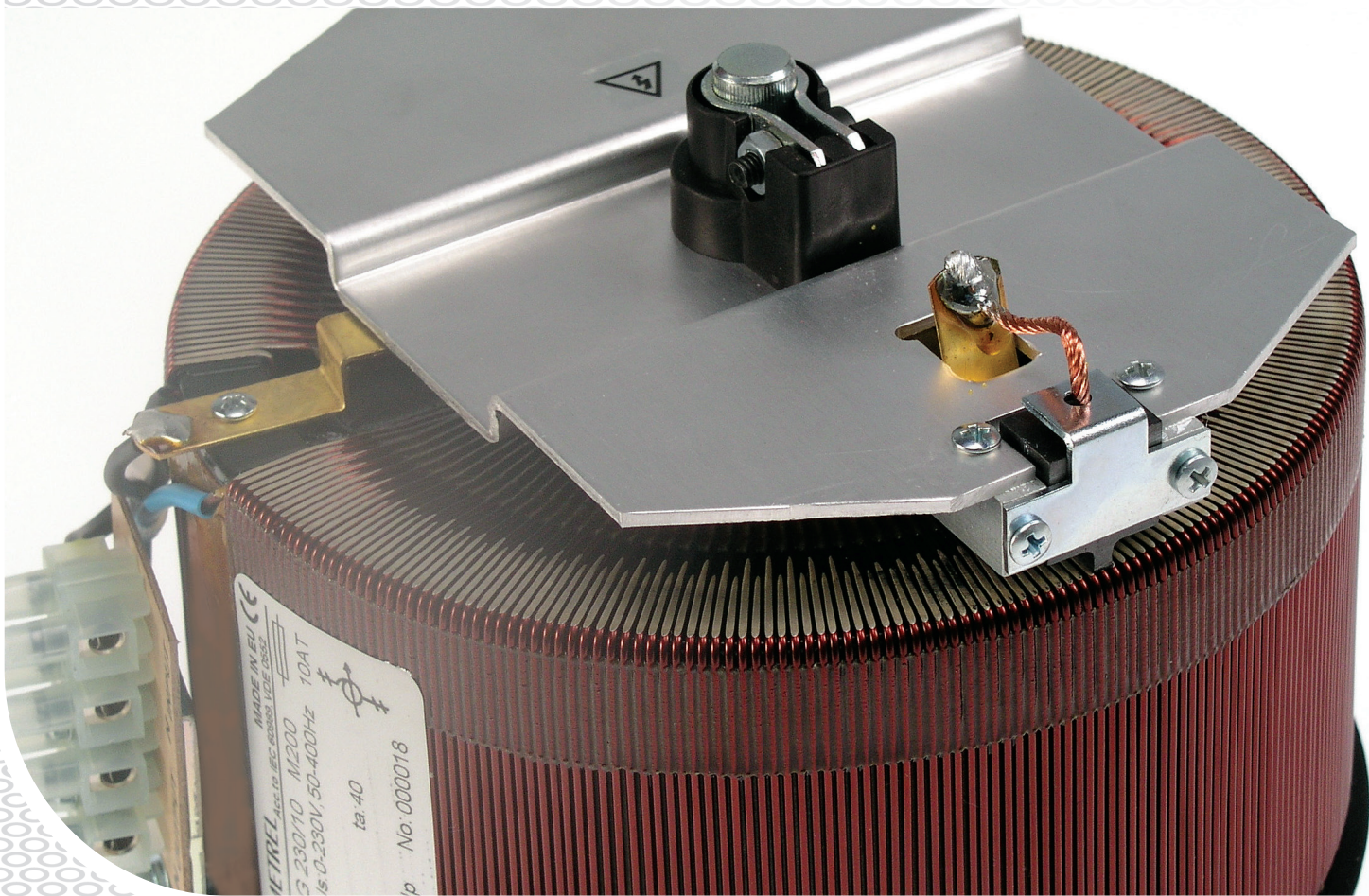

Single-phase Built-in Variable Transformers
Three-phase Built-in Variable Transformers
Motor driven Variable Transformers
Desk top Variable Transformers
Power Supplies

General

METREL is well known producer of variable transformers and power supplies which are widely accepted in laboratories, industry, schools.

The competitiveness of these products is based on a good price/performance ratio. They are robust in construction, they have low magnetizing current, low operating torque and no distortion or harmonics added. Copper winding is precision wound on a toroidal core.

Tradition with 50 years of experience in continuous production, product control, testing, safety, permanent improvements and customer service are firm in the production of METREL variable transformers.

Complete information on variable transformers and complete instrument product groups of METREL can be found on www.metrel.si.

METREL variable transformers are available as:

- Single or poly phase types
- Autotransformer or insulated variable transformer
- Manual or motor driven variable transformer
- Open / panel mount or enclosed construction
- Air-cooled, optional oil-cooled variable transformer

METREL variable transformers provide continuously adjustable voltage from zero to 100% or 113% of the line voltage. Their operation is simple and efficient.

Copper wire is wound on a toroidal core by using high precision winding machines.

Sliding trace of the winding is properly smoothed to provide low resistance and long wearing track for the carbon brush. Some models are silver plated, providing lower output impedance. The core is made of strip-wound oriented silicon steel for low electrical losses and high magnetic densities. The coil is insulated from the core by means of a special insulation support that also prevents movement of coil turns. Variable transformers are wound in a manner to ensure that voltage between the two turns is small enough to avoid harmful sparking or excessive heating of shorted turns.

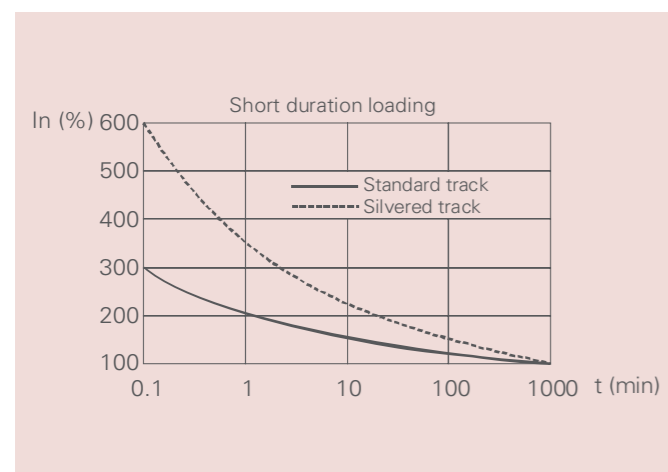

METREL variable transformers provide an output voltage waveform that is a precise reproduction of the applied input voltage waveform. Slider is mounted on shaft but electrically insulated from it. With a brush holder, it serves also as a heat sink. Only standard METREL variable transformers are listed in this catalogue.

Technical regulation

Three general regulations serve as a base for function, quality and safety of METREL variable transformers: European Low voltage directive 2006/95/EC (2014/35), International standard IEC 61558-1:2005+A1:2009 and IEC 61158-2-14:2012.

Applications

METREL variable transformers are applied to various products or applications including the following:

- Power supplies
- Laboratory and test equipment
- Speed control devices
- Computer peripheral equipment
- Welding controls
- Variable speed devices for large machinery
- Electroplating and anodising
- High-voltage electronic tube circuits
- Spare supply regulators in broadcast transmitters
- Voltage stabilizers
- High voltage test set
- Meter test bench
- Hydro generation plants
- Battery chargers
- DC motor controls
- Plastic blow moulding machines
- Control of furnace transformers
- Lightning regulation
- Laboratory stirrers
- AC, DC brush motors
- High current motorized voltage regulators
- High current plastic plating operations

Technical performances

High reliability

METREL variable transformers are practically maintenance free. Long-life operation is assured with:

- Precision winding
- Surface forming of winding
- Tight tolerances in preparing sliding track
- Deep varnishing and baking also for fixing winding structure
- A spring-loaded solid carbon brush

Power factor

Power factor of load has very little effect on the operation of a METREL variable transformer in the range from 0.5 lagging to 0.5 leading. Like any transformer, the METREL variable transformer reflects the load power factor to the line with very little change.

Only for very light loads, possibly under 10%, will the lagging power factor of the METREL variable transformer become significant due to magnetizing current.

High efficiency

METREL variable transformers have low electrical losses under all load conditions.

Efficiency is 98.5 percent at maximum output voltage selected. This efficiency remains high, even at greatly reduced load voltage.

Ambient temperature

METREL variable transformers are designed for continuous operation in ambient of 0 °C to 40 °C, at full rated load. When operated above 40 °C, the output power must be derated in accordance with diagram 1. For example, when operating model HSH 230/4 in a 60 °C ambient, rated output current would be: 70 % × 4 A = 2.8 A.

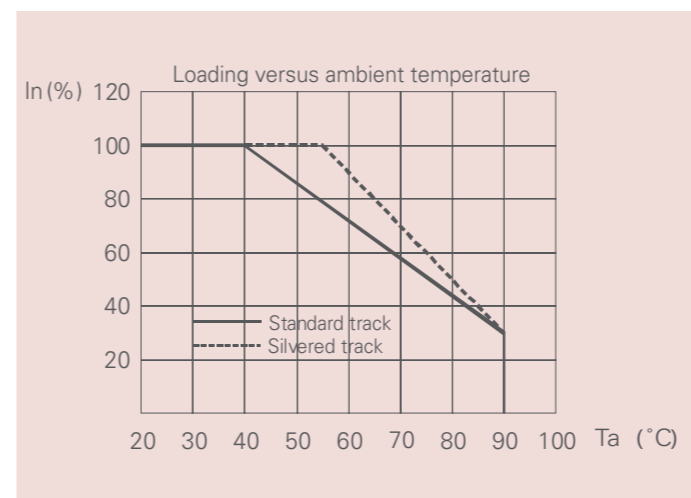

Frequency

All METREL variable transformers are designed for operation at 50/400 Hz. They may be operated at higher frequencies, without derating, however regulation becomes poorer. Units listed for 230 V operations may be applied on 115 V at 25 Hz, however rated currents remain the same.

Linear output voltage

METREL variable transformers have the advantage of providing output voltage that varies linearly in proportion to the angle of rotation of the output voltage selector. Because of the large number of increments of output voltage selection with the slider, the output voltage is practically steeples.

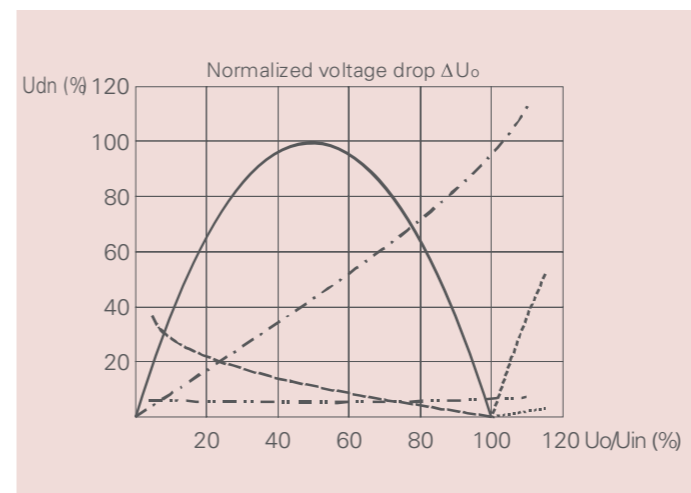

- $\Delta U_o / \Delta U_o$ max for autotransformer / U_o max = U_{in}
- - - $\Delta U_o / \Delta U_o$ max for autotransformer / U_o max > U_{in}
- · - · $\Delta U_o / \Delta U_o$ (at $U_o = U_{in}$) for separate secondary
- - - $\Delta U_o / U_o$ for separate secondary
- - - $\Delta U_o / U_o$ for autotransformer / U_o max = U_{in}
- - - $\Delta U_o / U_o$ for autotransformer / U_o max > U_{in}

Installation guidelines

For safety and reliable operation of METREL variable transformers the following requirements need to be fulfilled:

- good venting
- appropriate wiring
- over current protection
- avoiding corrosive, high humidity and dust places or protection against these environmental conditions,
- preventing short circuits on axis,
- appropriate design and construction of equipment with built-in variable transformers.

Venting of power devices reduces their heating and thus rat-

ed performances can be applied. Power lines must have high enough cross-section, be fixed and secured with good contact to prevent overheating and additional voltage drops. Primary over-current breaking device must be properly selected and use of load protection fuses is recommended. Fuses / residual circuit breakers (RCD) prevent excessive heating due to overload and prevent fire generation as a result of overheating.

Regardless if the variable transformers are designed for harsh environment, it is best for reliable operation and long lifetime to keep them in non-aggressive environment. The axis is on one side connected to metal base. If the other side of axis is electrically connected to the same base (through the housing), this will present a short circuit coil of the transformer with increasing power consumption, overheating, and even generating high leakage currents and stray magnetic fields.

It is important that the brushes are not leaving in one spot for extended periods to avoid gradually increase contact resistance and eventual overheating and damage of the variable transformer unit.

Options

Parallel connections

METREL has a solution for paralleling two single-phase transformers. Output current can be doubled by using the balancing choke and mechanical paralleling of sliders on common shaft.

Serial connections

Serial connection is intended for application of variable transformers in installations with higher input voltage than rated. Two variable transformers of the same type are connected in series and enable operation with double voltage of rated for one.

Dual voltage tap slides

This possibility enables generating variable differential voltage with the same or opposite phase related to input voltage. Typical applications are boosting regulators.

Shaft modifications

The shaft provided with each model accommodates the METREL transformer's voltage selector knob when mounted on panels not exceeding the thickness shown in dimension data. Modification to the shaft, either in length or end diameter, is available for both manual and motor-operated units.

Product groups

- Open variable transformer types (subassemblies for panel mount or other built-in equipment) HSG; HST; HTG; HSM; HTM with Accessories (Buttons, Scales, Motor drives)
- Desk top variable transformer types (HSN, HTN)
- Power supplies (MA 4804, MA 4852, MA 4853)

General technical data

Frequency range:	50 Hz - 400 Hz
Mechanical angle:	340 , core size up to M200 320 , other core sizes
Protection class:	I
Pollution degree:	2
Protection degree:	IP 20
Altitude (operation):	2000 m
Test voltage (input to metallic accessible parts):	2500 V a.c. rms, 50 Hz, 2 s
Test voltage (input/output, HST):	4000 V a.c. rms, 50 Hz, 2 s
Operating temperature range:	-5 °C to 40 °C
Operating humidity range:	90 % RH (40 °C), non-condensing
Storage temperature range:	-15 °C to 70 °C

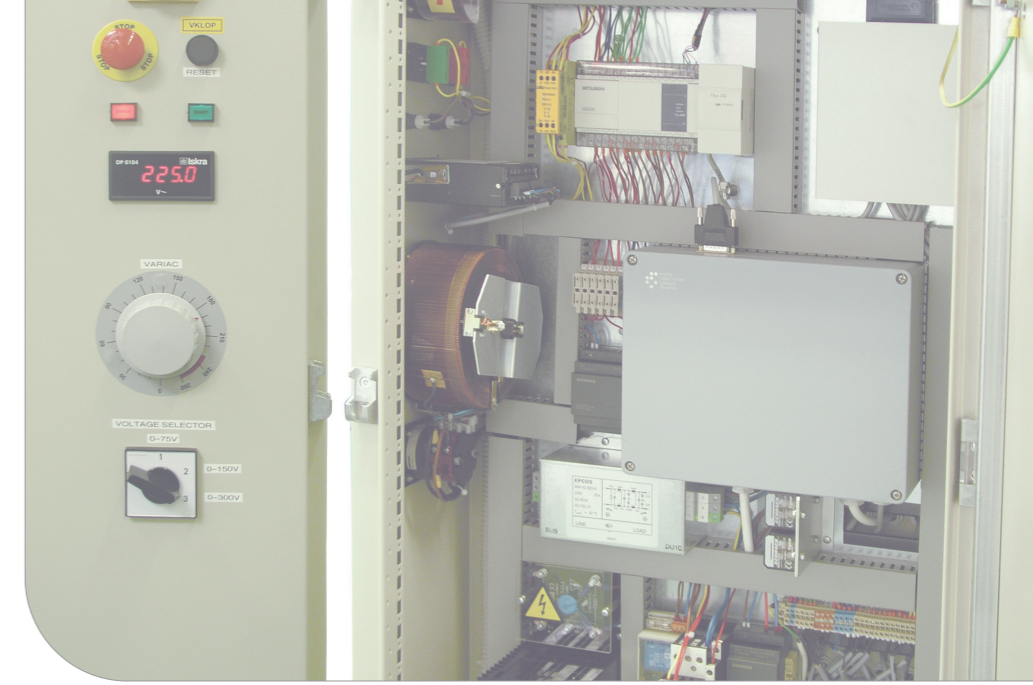
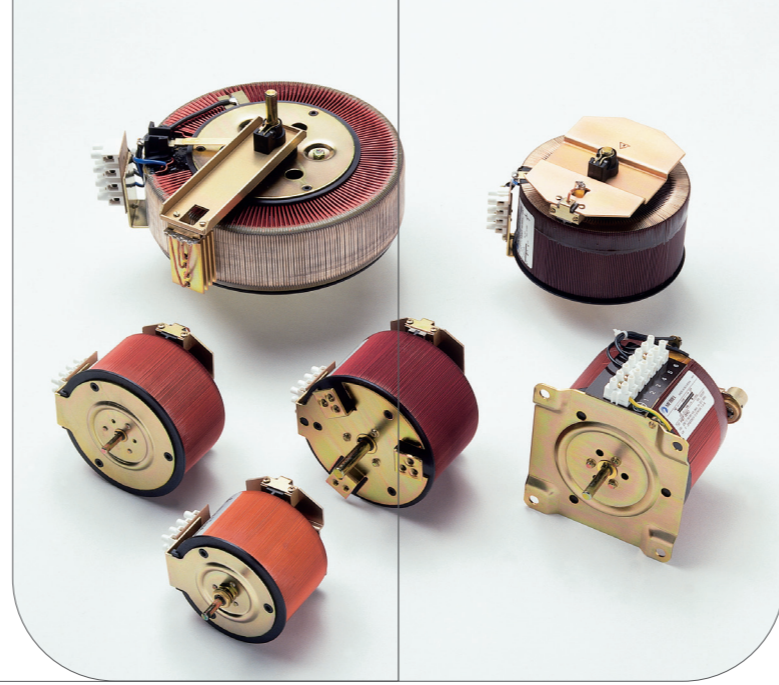
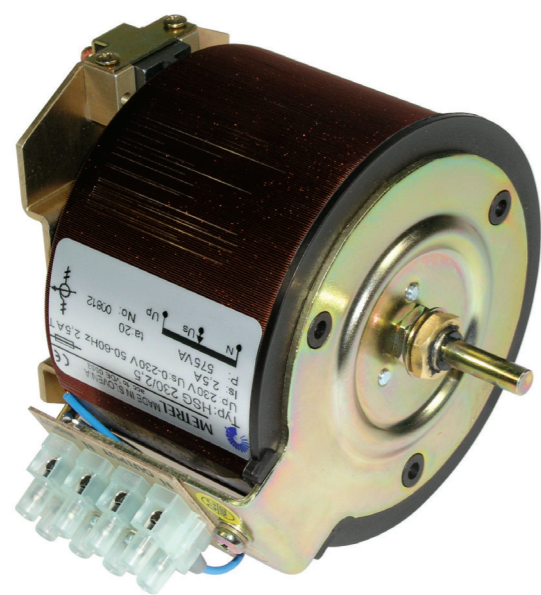

One-phase Built-in Variable Transformers

HSG - Autotransformers

The HSG series voltage transformers are often built in test equipment or permanent installations.

Output voltage is controlled with a large, slip-protected knob. Output voltage is increased linearly as the knob is turned clockwise. The user is required to add adequate external over-current protection device like fuse or circuit breaker.

All models are suitable for 50 Hz/60 Hz frequency range. Single- and 3-phase models are available with various current ratings. Output voltage is precisely controlled. Autotransformer design allows optional voltage boost.

Because of demanding applications all Metrel variacs are designed to exhibit superior resistance to high temperature, humidity and mechanical shocks/vibrations.

Used in hardwired, permanent installations wherever operational or performance points need to be varied.

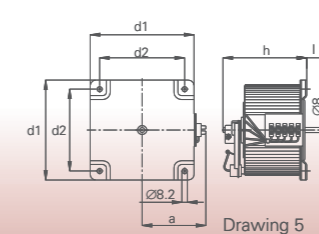
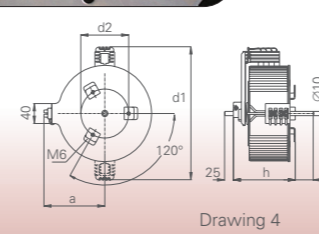
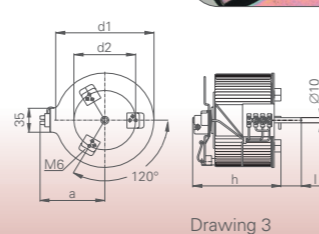
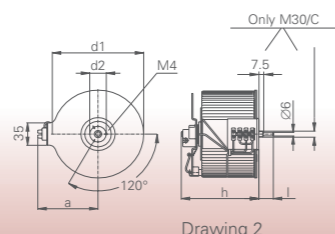
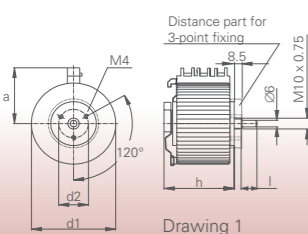
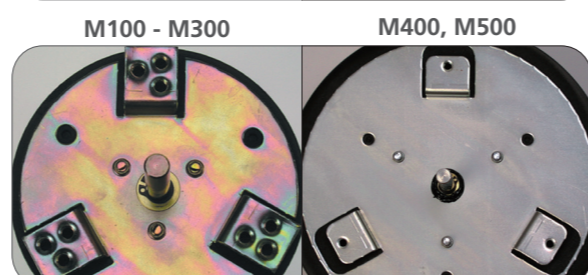
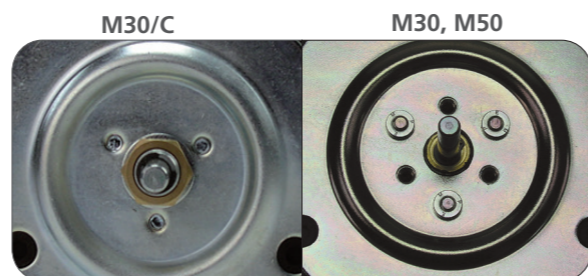
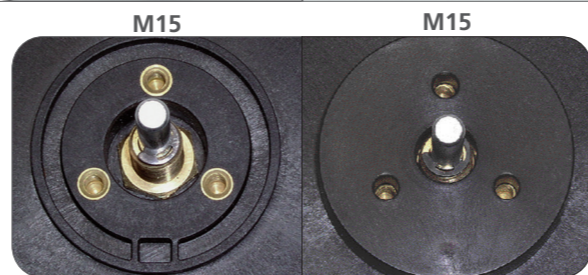
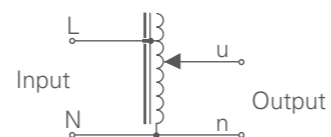
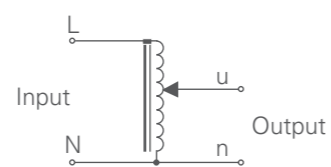

Technical Specification

HSG type (Input voltage 230 V)						Dimensions							
Output voltage 0 ÷ 230 V			Output voltage 0 ÷ 260 V			Model	a	d1	d2	h	l	Drawing	
Type	Is (A)	P (VA)	Type	Is (A)	P (VA)	Mass (kg)	Model	a	d1	d2	h	l	Drawing
HSG 230/1	1.0	230	HSG 260/0.8	0.8	208	1.4	M15	52	85	26	70	20	1
HSG 230/1.6	1.6	368	HSG 260/1.4	1.4	364	2.4	M30	74	100	26	100	20	2
HSG 230/2	2.0	460	HSG 260/1.6	1.6	416	2.4	M30 or M30/C	M30/C	74	100	100	27.5	2
HSG 230/2.5	2.5	575	HSG 260/2	2.0	520	2.4	M50	83	119	26	100	20	2
HSG 230/3	3.0	690	HSG 260/2.5	2.5	650	3.5	M100	86	125	80, 95, 100	121	30	3
HSG 230/4	4.0	920	HSG 260/3	3.0	780	3.5	M200	100	153	80, 95, 100	121	30	3
HSG 230/4.5	4.5	1035	HSG 260/3.5	3.5	910	4.6	M250	110	174	80, 95, 100	121	30	3
HSG 230/6	6.0	1380	HSG 260/4.5	4.5	1170	4.6	M300	149	226	100	117	52	3
HSG 230/8	8.0	1840	HSG 260/6.3	6.3	1638	7.0	M400	155	300	160	120	52	4
HSG 230/10	10.0	2300	HSG 260/8	8.0	2080	7.0	M500	175	340	160	135	52	4
HSG 230/12	12.0	2760	HSG 260/10	10.0	2600	9.2							
HSG 230/18	18.0	4140	HSG 260/15	15.0	3900	13.3							
HSG 230/23	23.0	5290	HSG 260/20	20.0	5200	14.0							
HSG 230/32	32.0	7360	HSG 260/30	30.0	7800	20.5							

HST - Separating transformers

Variable, coupled with insulation transformers are utilized for personnel safety in addition to provide variable voltages for testing purposes. In general they are equally suitable for any of the testing, engineering or control function like ordinary variacs based on autotransformer design. Additionally they can isolate sensitive equipment from interference and ground noise.

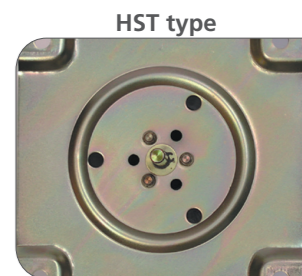
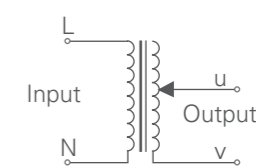

Optional Accessories

Buttons

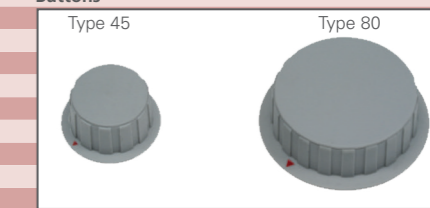

Type	For model	Dimension (∅ x h)	Code No.
45	M15	45 x 22 mm	90 280 107
45	M30	45 x 22 mm	90 280 107
45	M50	45 x 22 mm	90 280 107
80	M100	80 x 23,5 mm	90 280 108
80	M200	80 x 23,5 mm	90 280 108
80	M205	80 x 23,5 mm	90 280 108
80	M300	80 x 23,5 mm	90 280 108
80	M400	80 x 23,5 mm	90 280 108
80	M500	80 x 23,5 mm	90 280 108
80	HST	80 x 23,5 mm	90 280 096

Scales

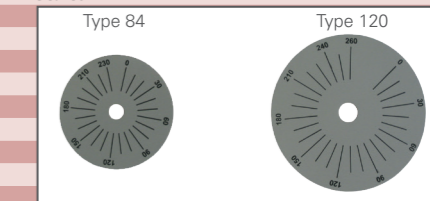

Type	U output (V)	Dimension (∅)	Code No.
84	0 - 48	84 mm	18 285 684
84	0 - 230	84 mm	18 285 023
84	0 - 260	84 mm	18 285 024
84	0 - 400	84 mm	18 285 029
84	0 - 450	84 mm	18 285 030
84	0 - 100 %	84 mm	18 285 027
120	0 - 230	120 mm	18 285 025
120	0 - 260	120 mm	18 285 026
120	0 - 400	120 mm	18 285 031
120	0 - 450	120 mm	18 285 032
120	0 - 100 %	120 mm	18 285 028
120	0 - 100 %	120 mm	18 285 048**

HST type					
Type	Up (V)	Us (V)	Is (A)	P (VA)	Mass (kg)
HST 0052	230	0 ÷ 34 (30)*	6	180	3.9
HST 0062	230	0 ÷ 253 (230)*	1.8	414	5.4
HST 0102	230	0 ÷ 245 (230)*	3.1	713	7.8

* at rated output current

Type	a	d1	d2	h	l	Drawing
HST 0052	86	130	110	123	30	5
HST 0062	86	130	110	123	30	5
HST 0102	98	155	127	134	30	5

** for HST type

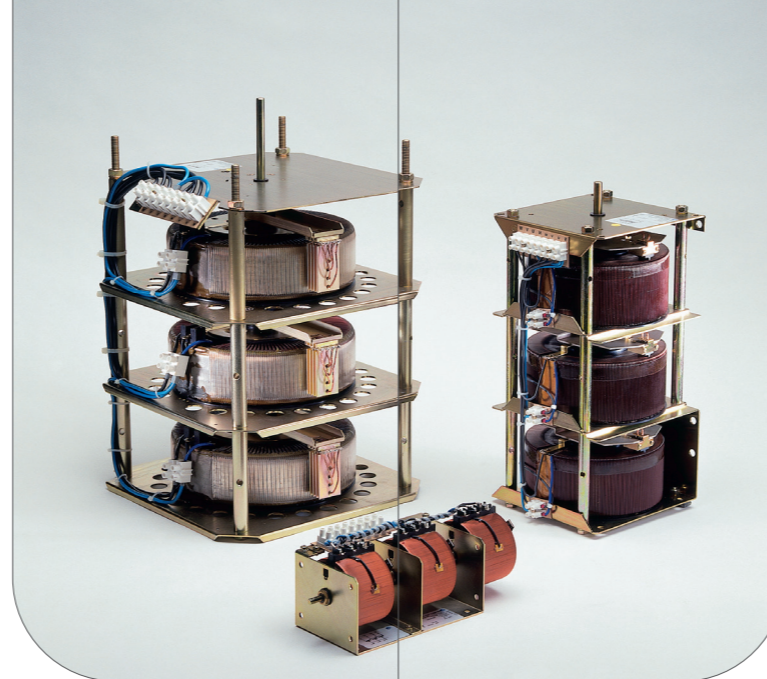
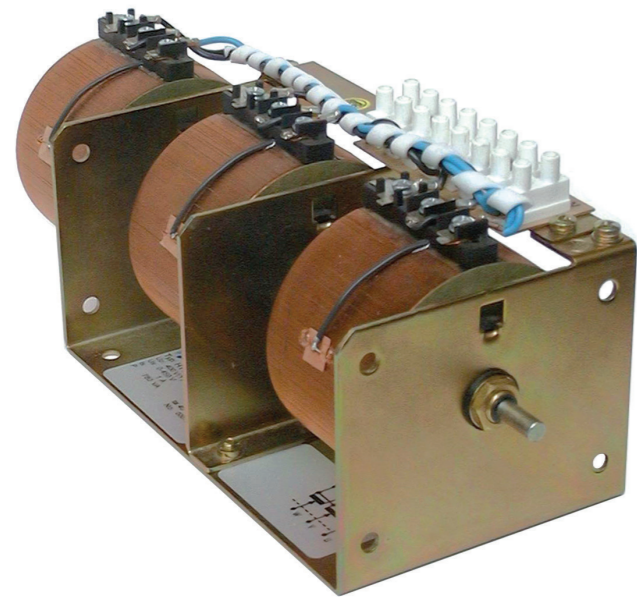

Three-phase Built-in Variable Transformers

HTG - Autotransformers

3-phase connections

METREL three-phase transformers are suitable for connection to either delta or star connected incoming power sources or loads. They are always star connected and have a neutral connection accessible. A common shaft rotates all output voltage sliders in parallel.

3-phase METREL transformers with 3-wire connection to 3-phase supply system can be used to feed 3-wire, 3-phase balanced loads. In this case the common connection (or "virtual neutral") of the METREL unit should not be used. Less than 10% of rated current of variable transformers flowing into virtual neutral would keep unbalance of three-phase output in reasonable limits.

With a three phase, 4-wire system input, the system neutral should be solidly connected to the common or "neutral" point of the METREL unit. This will prevent neutral shift and possible damage or failure of the unit. Full-range voltage control cannot be obtained from a three-phase METREL unit consisting of three single-phase units connected in closed delta. Outside the factory, it is not practical to convert multiple single-phase models to balanced three-phase applications because of associated mechanical problems.

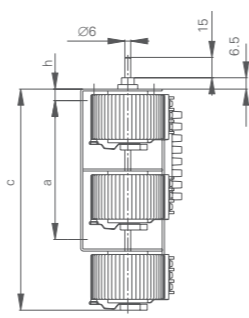
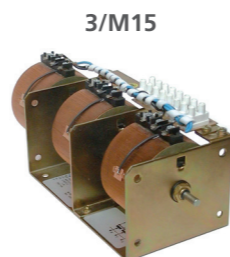
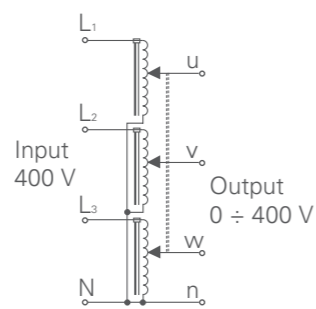
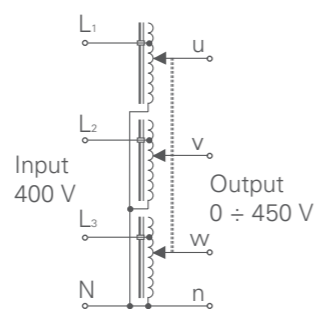

3/M100, 3/M50

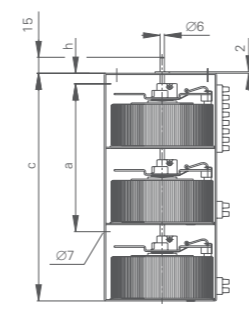

3/M100, 3/M200, 3/M250

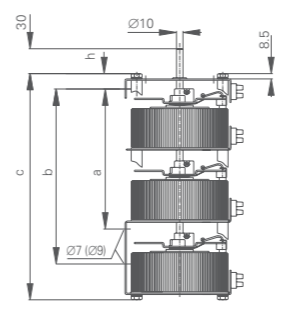

3/M300, 3/M400, 3/M500

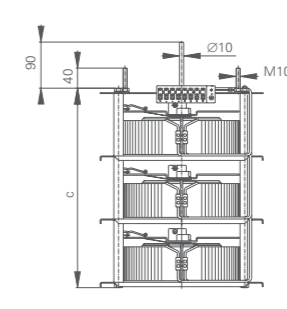
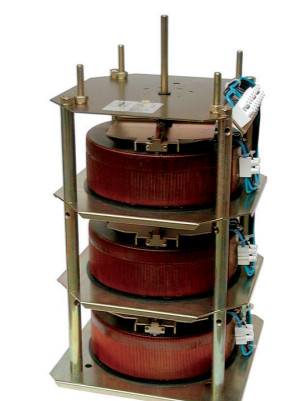

Special version



Optional Accessories

Buttons

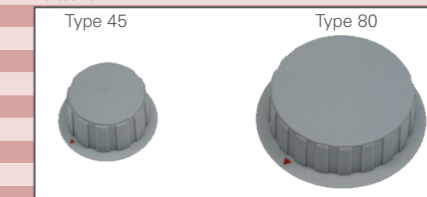

Type	For model	Dimension (∅ x h)	Code No.
45	M15	45 x 22 mm	90 280 107
45	M30	45 x 22 mm	90 280 107
45	M50	45 x 22 mm	90 280 107
80	M100	80 x 23,5 mm	90 280 108
80	M200	80 x 23,5 mm	90 280 108
80	M205	80 x 23,5 mm	90 280 108
80	M300	80 x 23,5 mm	90 280 108
80	M400	80 x 23,5 mm	90 280 108
80	M500	80 x 23,5 mm	90 280 108
80	HST	80 x 23,5 mm	90 280 096

Scales

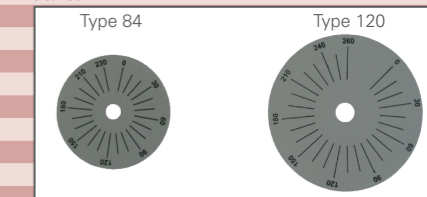

Type	U output (V)	Dimension (∅)	Code No.
84	0 - 48	84 mm	18 285 684
84	0 - 230	84 mm	18 285 023
84	0 - 260	84 mm	18 285 024
84	0 - 400	84 mm	18 285 029
84	0 - 450	84 mm	18 285 030
84	0 - 100 %	84 mm	18 285 027
120	0 - 230	120 mm	18 285 025
120	0 - 260	120 mm	18 285 026
120	0 - 400	120 mm	18 285 031
120	0 - 450	120 mm	18 285 032
120	0 - 100 %	120 mm	18 285 028
120	0 - 100 %	120 mm	18 285 048**

** for HST type

Technical Specification

HTG type (Input voltage 400 V)

Output voltage 0 ÷ 400 V			Output voltage 0 ÷ 450 V				
Type	Is (A)	P (VA)	Type	Is (A)	P (VA)	Mass (kg)	Model
HTG 400/1	1.0	690	HTG 450/0.8	0.8	624	4.85	3/M15
HTG 400/1.6	1.6	1104	HTG 450/1.4	1.4	1092	8.1	3/M30
HTG 400/2	2.0	1380	HTG 450/1.6	1.6	1248	8.1	3/M30
HTG 400/2.5	2.5	1725	HTG 450/2	2.0	1560	8.1	3/M30
HTG 400/3	3.0	2070	HTG 450/2.5	2.5	1950	11.9	3/M50
HTG 400/4	4.0	2760	HTG 450/3	3.0	2340	11.9	3/M50
HTG 400/4.5	4.5	3105	HTG 450/3.5	3.5	2730	15.1	3/M100
HTG 400/6	6.0	4140	HTG 450/4.5	4.5	3510	15.1	3/M100
HTG 400/8	8.0	5520	HTG 450/6.3	6.3	4914	23.6	3/M200
HTG 400/10	10.0	6900	HTG 450/8	8.0	6240	23.6	3/M200
HTG 400/12	12.0	8280	HTG 450/10	10.0	7800	29.8	3/M250
HTG 400/18	18.0	12420	HTG 450/15	15.0	11700	51.2	3/M300
HTG 400/23	23.0	15870	HTG 450/20	20.0	15600	56	3/M400
HTG 400/32	32.0	22080	HTG 450/30	30.0	23400	70	3/M500

Dimensions

Model	a	b	c	d	e	f	g	h	Drawing
3/M15	154	-	246	80	100	48	105	15	1
3/M30	234	-	323	80	100	55	110	15	2
3/M50	243	-	323	110	124	64	149	18	3
3/M100	243	284	370	110	130	67	153	21	3
3/M200	243	284	370	160	178	90	200	21	3
3/M250	243	284	370	160	178	90	200	21	3
3/M300	-	-	402	178	275	138	275	-	4
3/M400	-	-	402	249	310	155	310	-	4
3/M500	-	-	466	249	350	175	350	-	4

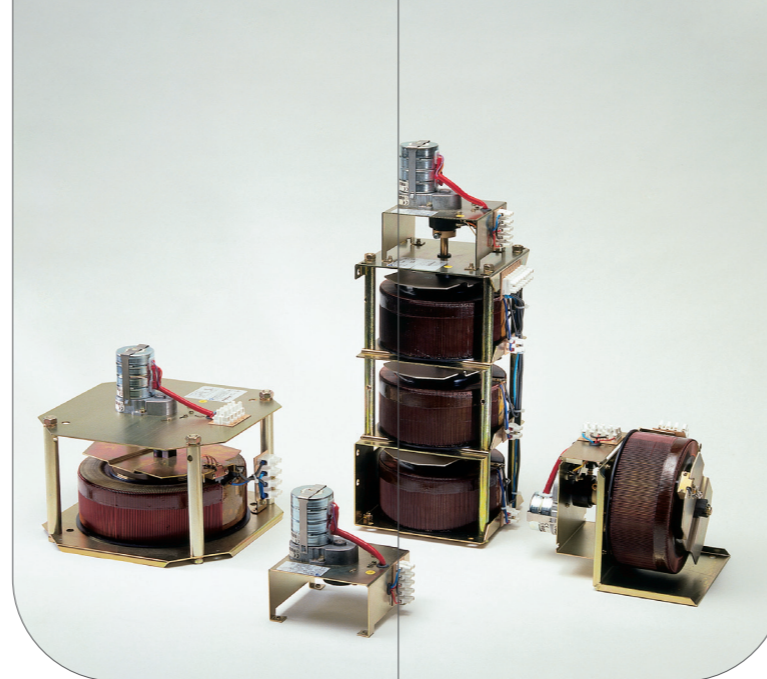
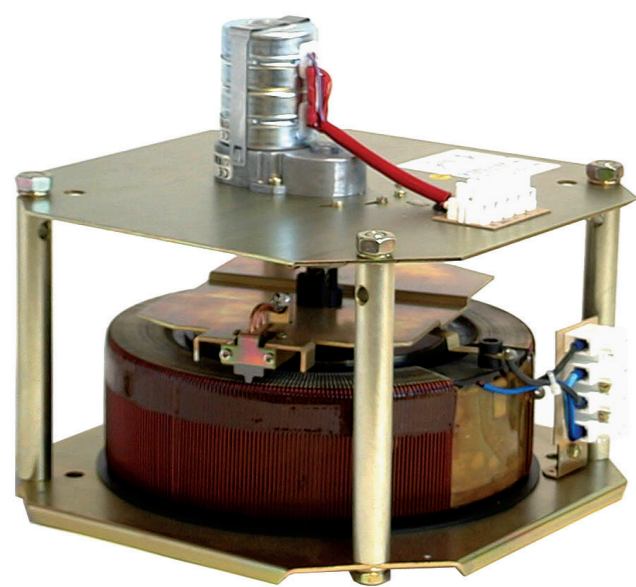

Motor driven Variable Transformers

HSM - single phase, HTM - three phase

METREL motor-operated units differ from manual types primarily in the means used to rotate the shaft to vary output voltage. A synchronous motor is used to position the slider. The motor is reversible by means of a SPDT switch (not supplied) and operates on 230 V, 50 / 60 Hz. Integrated limit switches prevent overriding the winding edges.

Typical methods for controlling METREL motor-operated units include:

- Manual increase/decrease switch consists of either momentary-contact push-button or lever-type toggle switch.
- Relays and contactors control the increase/decrease power to the motor as a result of low-level signals from external circuitry. Example: photoelectric cells or thermostat signals can provide the input.
- Process control instrumentation can be used for closed-loop, precise control, and more sophisticated circuitry to provide the raise-fall switching for the motor.

Motor operating time refers to the number of seconds for the motor to traverse its full range in one direction. METREL transformers have standard 23 s motor operating time. Other motor operating times are optional.

Variable transformer with motor drive

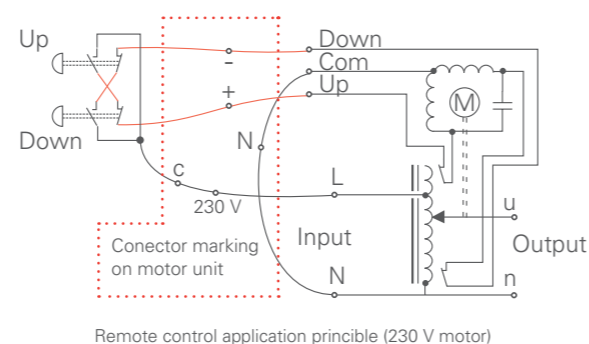
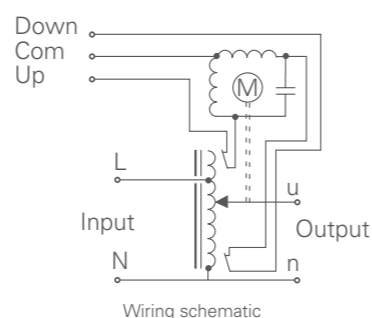

3/M50, 3/M100, 3/M200, 3/M250,
3/M300, 3/M400, 3/M500

M 50, M100, M200, M250

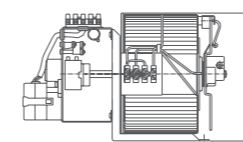
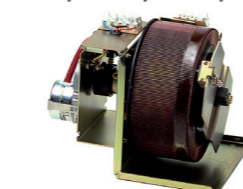

Drawing 1

M300, M400, M500

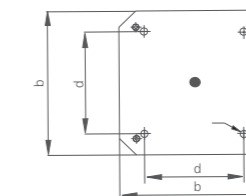
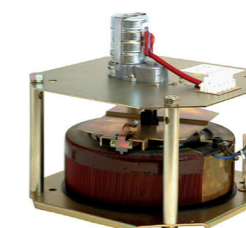

Drawing 2

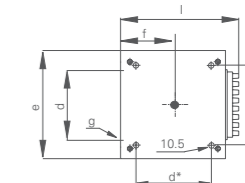
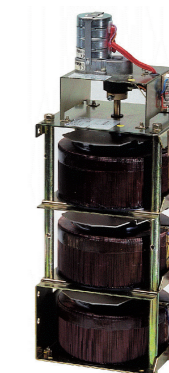

Drawing 3

Technical Specification

HSM type (Input voltage 230 V)

Output voltage 0 ÷ 230 V			Output voltage 0 ÷ 260 V				
Type	I _s (A)	P (VA)	Type	I _s (A)	P (VA)	Mass (kg)	Model
HSM 230/3	3.0	690	HSM 260/2.5	2.5	650	4.5	M50
HSM 230/4	4.0	920	HSM 260/3	3.0	780	4.5	M50
HSM 230/4.5	4.5	1035	HSM 260/3.5	3.5	910	5.6	M100
HSM 230/6	6.0	1380	HSM 260/4.5	4.5	1170	5.6	M100
HSM 230/8	8.0	1840	HSM 260/6.3	6.3	1638	8.0	M200
HSM 230/10	10.0	2300	HSM 260/8	8.0	2080	8.0	M200
HSM 230/12	12.0	2760	HSM 260/10	10.0	2600	10.2	M250
HSM 230/18	18.0	4140	HSM 260/15	15.0	3600	14.3	M300
HSM 230/23	23.0	5290	HSM 260/20	20.0	5200	15.0	M400
HSM 230/32	32.0	7360	HSM 260/30	30.0	7800	21.5	M500

HTM type (Input voltage 400 V)

Output voltage 0 ÷ 400 V			Output voltage 0 ÷ 450 V				
Type	I _s (A)	P (VA)	Type	I _s (A)	P (VA)	Mass (kg)	Model
HTM 400/3	3.0	2070	HTM 450/2.5	2.5	1950	12.9	3/M50
HTM 400/4	4.0	2760	HTM 450/3	3.0	2340	12.9	3/M50
HTM 400/4.5	4.5	3105	HTM 450/3.5	3.5	2730	16.1	3/M100
HTM 400/6	6.0	4140	HTM 450/4.5	4.5	3510	16.1	3/M100
HTM 400/8	8.0	5520	HTM 450/6.3	6.3	4914	24.6	3/M200
HTM 400/10	10.0	6900	HTM 450/8	8.0	6240	24.6	3/M200
HTM 400/12	12.0	8280	HTM 450/10	10.0	7800	30.8	3/M250
HTM 400/18	18.0	12420	HTM 450/15	15.0	11700	46.5	3/M300
HTM 400/23	23.0	15870	HTM 450/20	20.0	15600	49.0	3/M400
HTM 400/32	32.0	22080	HTM 450/30	30.0	23400	71.5	3/M500

Dimensions

Model	a	b	c	d	e	f	g	h	i	k	Drawing
M30	147	198	110	100	100	25	Ø4.5	-	-	-	1
M50	147	198	110	100	100	25	Ø4.5	-	-	-	1
M100	180	240	180	150	90	20	Ø9	-	-	-	1
M200	180	240	180	150	90	20	Ø9	-	-	-	1
M250	180	240	180	150	90	20	Ø9	-	-	-	1
M300	238	375	170	178	-	-	Ø10.5	-	-	-	2
M400	238	310	170	216	-	-	Ø10.5	-	-	-	2
M500	248	340	180	249	-	-	Ø10.5	-	-	-	2
Model	a	b	c	d (d*)	e	f	g	h	i	k	Drawing
3/M50	114	284	323	110	124	64	Ø7	18	149	460	3
3/M100	343	284	370	110	130	67	Ø7	21	153	510	3
3/M200	343	284	370	160	178	90	Ø9	21	200	510	3
3/M250	343	284	370	160	178	90	Ø9	21	200	510	3
3/M300	-	-	402	178*	275	138	-	-	275	605	3
3/M400	-	-	402	216*	310	155	-	-	310	600	3
3/M500	-	-	466	249*	350	175	-	-	350	660	3



Desk top Variable Transformers

HSN - single phase, HTN - three phase

The HSN and HTN series voltage transformers are fully housed, thus providing protection from physical accidents, and other hazards. Generally they are used wherever adjustable a.c. voltage is required. Output voltage is precisely controlled.

Output voltage is controlled with a large, slip-protected knob. Output voltage is increased linearly as the knob is turned clockwise. All models are equipped with power cord, illuminated on/off switch and external PE terminal and optional with appropriate plug connector. They are marked with output voltage in volts (corresponding to nominal input voltage).

They can be conveniently moved around laboratory, production or equipment service area to provide adjustable voltage.

All models are suitable for 50 Hz/60 Hz frequency range. Single- and 3-phase models are available with various current ratings.

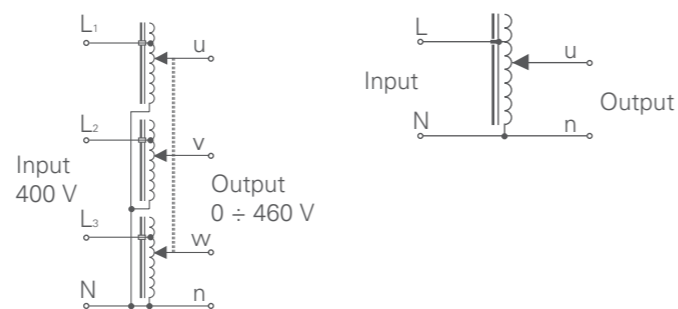

3/M200, 3/M250, 3/M300

3/M400, 3/M500

M100, M200, M250

M300, M400, M500



Technical Specification

HSN type							Dimension (x x h x l)
Type	Up (V)	Us (V)	Is (A)	P (VA)	Mass (Kg)	Model	
HSN 260/4.5	230	0 ÷ 260	4.5	1170	5.4	M100	170 x 155 x 220 mm
HSN 260/8	230	0 ÷ 260	8.0	2080	7.9	M200	203 x 155 x 253 mm
HSN 260/10	230	0 ÷ 260	10.0	2600	10.1	M250	270 x 155 x 320 mm
HSN 260/15	230	0 ÷ 260	15.0	3900	18.6	M300	285 x 228 x 315 mm
HSN 260/20	230	0 ÷ 260	20.0	5200	20.1	M400	318 x 228 x 348 mm
HSN 260/30	230	0 ÷ 260	30.0	7800	28.2	M500	357 x 228 x 387 mm

HTN type							Dimension (x x h x l)
Type	Up (V)	Us (V)	Is (A)	P (VA)	Mass (Kg)	Model	
HTN 450/8	400	0 ÷ 450	8.0	6240	28.7	3/M200	240 x 420 x 285 mm
HTN 450/10	400	0 ÷ 450	10.0	7800	34.7	3/M250	240 x 420 x 285 mm
HTN 450/15	400	0 ÷ 450	15.0	11700	52.5	3/M300	285 x 520 x 315 mm
HTN 450/20	400	0 ÷ 450	20.0	15600	56.0	3/M400	318 x 520 x 348 mm
HTN 450/30	400	0 ÷ 450	30.0	23400	79.4	3/M500	357 x 590 x 405 mm

Power Supplies



MA - Power Supplies

The MA 4804, MA 4852 and MA 4853 are power supply units with the built-in variable transformers permitting a continuous voltage adjustment within the limits of declared specifications. The transformers have separate primary and secondary windings resulting in galvanic isolation of the mains circuit from output circuit. This is frequent requirement for energizing specific electrical devices. The power supply units are equipped with V-meter and A-meter, which allow a permanent control over output voltage and current. They are overload-protected with a circuit-breaker which disconnects the secondary circuits when a short-circuit condition occurs at the output.

Field Application

The MA 4804, MA 4852 and MA 4853 power supply units are used in electronic industry (electrical and control labs), in service workshops, in technical education, etc., briefly everywhere adjustable supply voltage is needed, or where for

technical or safety reasons the power supply source has to be galvanically insulated from the mains. Test voltage of 4 kV a.c. rms between input and output enables using the units in CAT III 300 V environment.

Characteristics

MA 4804 is a source of adjustable a.c. voltage from 0 to 245 V, with permissible permanent load of 3.1 A. The unit contains special circuit to prevent high inrush current.

MA 4852 is a low-voltage source of a.c. and d.c. voltage. The d.c. voltage can be adjusted in the range of 0 to 46 V and a.c. voltage from 0 to 33 V. The permissible total current load is 6 A. The power supply unit has a built-in C filter for filtering out d.c. voltage.

MA 4853 is a power supply unit with improved characteristic of MA 4852. A CLC filter is incorporated for d.c. output voltage smoothing.

MA 4804

MA 4852

MA 4853



Technical Specification

	MA 4804	MA 4852	MA 4853
Power supply:	230 V, 50-60 Hz	230 V, 50-60 Hz	230 V, 50-60 Hz
Output voltage:			
a.c. voltage	0 ÷ 245 V (230 V)*	0 ÷ 33 V (30 V)*	0 ÷ 33 V (30 V)*
d.c. voltage	-	0 ÷ 46 V (32 V)*	0 ÷ 46 V (32 V)*
Maximum continuous permanent currents:	3.1 A	6 A (d.c. + a.c.ef)	6 A (d.c. + a.c.ef)
Ripple of the d.c. output:	-	<15 Vpp (I=6 A)	<200 mVpp (I= 6 A)
		<3.5 Vpp (I=1 A)	<30 mVpp (I= 1 A)
Operating temperature range:	-5 ÷ +40 °C	-5 ÷ +40 °C	-5 ÷ +40 °C
Dimensions (w x h x l):	228 x 216 x 210 mm	228 x 216 x 210 mm	228 x 216 x 210 mm
Weight:	11 kg	8.2 kg	9.1 kg

* at rated output current

Load/overload characteristics

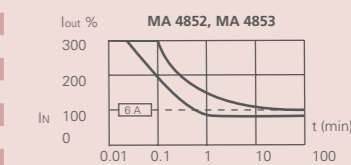
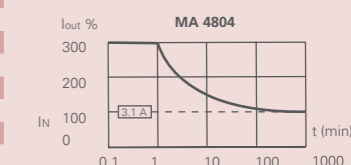

Short Glossary

Transformer - is a static piece of apparatus which, by electro-magnetic induction, transforms alternating voltage and current between two or more windings at the same frequency and usually at different values of voltage and current.

Variable transformer - denotes a transformer where the transformation ratio can be altered almost infinitely under load, by means of a current which is moved along a path in contact with successive locally turns along the winding and in a direction parallel to the axis.

Separating transformer - denotes a transformer with one or more input winding(s) separated from the output winding(s) by least basic insulation.

Autotransformer - An autotransformer has only a single winding which is tapped at some point along the winding. AC or pulsed voltage is applied across a portion of the winding, and a higher (or lower) voltage is produced across another portion of the same winding.

Power factor - The power factor of an AC electric power system is defined as the ratio of the real power to the apparent power, and is a number between 0 to 1 inclusive. Real power is the capacity of the performing work in a particular time. Apparent power is the product of the current and voltage of the circuit.

Brush (electric) - In electrical engineering, brushes conduct current between stationary wires and moving parts, most commonly in a rotating shaft.

Note! Photographs in this catalogue may slightly differ from the instruments at the time of delivery.
Subject to technical change without notice.



METREL®

**Measuring and Regulation
Equipment Manufacturer**

METREL d.d.

Ljubljanska 77

SI-1354 Horjul

Tel: + 386 (0)1 75 58 200

Fax: + 386 (0)1 75 49 226

E-mail: metrel@metrel.si

<http://www.metrel.si>