

# TBA641 ✓

## AUDIO AMPLIFIER

### FAIRCHILD LINEAR INTEGRATED CIRCUIT

**GENERAL DESCRIPTION** – The TBA641 is a monolithic integrated circuit designed for use as an audio power amplifier in portable radio receivers, tape recorders, record players and in industrial applications which require high output power, low distortion and high reliability performance.

Special features of the circuit include low quiescent current, self-centering bias operation at supply voltages ranging from 6 V to 12 V (16 V on TBA641 B11) and direct coupling of the input. The circuit requires a minimum of external components. It is constructed on a single silicon chip using the Fairchild Planar\* process.

- **OUTPUT POWER 2.2 W (9 V – 4 Ω) – TBA641 A12**
- **OUTPUT POWER 4.5 W (14 V – 4 Ω) – TBA641 B11**
- **LOW DISTORTION**
- **LOW QUIESCENT CURRENT**
- **SELF-CENTERING BIAS**
- **HIGH INPUT IMPEDANCE**

#### ABSOLUTE MAXIMUM RATINGS

	TBA641 A12	TBA641 B11
Supply Voltage (no signal)	12 V	18 V
Supply Voltage	12 V	16 V
Input Voltage	-0.5 V to V+	-0.5 V to V+
Peak Output Current	2 A	2.5 A
Storage Temperature	-40°C to +150°C	-40°C to +150°C
Power Dissipation (T <sub>A</sub> ≤ 25°C)	1.5 W	2.3 W
Power Dissipation (T <sub>A</sub> = 70°C)		1.45 W
Power Dissipation (T <sub>C</sub> = 70°C)		6 W
Max. Junction Temperature	150°C	150°C

#### THERMAL DATA (Typical)

	TBA641 A12	TBA641 B11
θ <sub>J-C</sub> (thermal resistance junction to case)	13°C/W	13°C/W
θ <sub>J-A</sub> (thermal resistance junction to ambient)	83°C/W	55°C/W

**CONNECTION DIAGRAM**  
14-PIN DIP  
(TOP VIEW)

PACKAGE OUTLINE 9H 9J  
PACKAGE CODE A12 B11

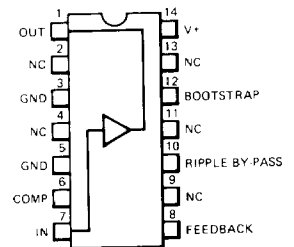

#### ORDER INFORMATION

TYPE	PART NO.
TBA641 A	TBA641A12
TBA641 B	TBA641B11

#### EQUIVALENT CIRCUIT

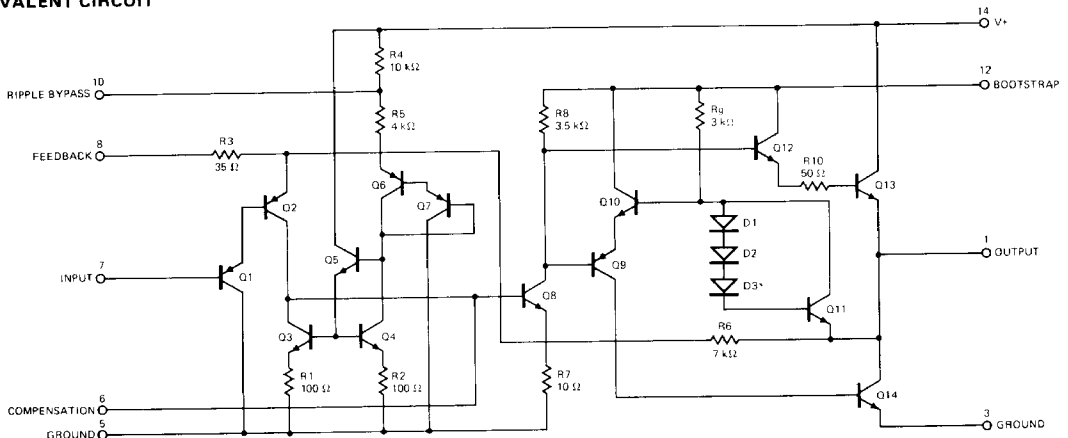

\*Planar is a patented Fairchild process.

TBA641 B11

**ELECTRICAL CHARACTERISTICS:**  $V_+ = 14\text{ V}$ ,  $R_L = 4\ \Omega$ ,  $T_A = +25^\circ\text{C}$  unless otherwise specified. (See Test Circuit)

CHARACTERISTICS	CONDITIONS	MIN	TYP	MAX	UNITS
Total Supply Current	$P_{OUT} = 0$		16	32	mA
Quiescent Current of Output Transistors	$P_{OUT} = 0$		13		mA
Input Bias Current (Pin 7)			250		nA
DC Output Level (Pin 1)		6.5	7	8	V
Voltage Gain	$R_f = 0\ \Omega$		46		dB
Output Power	THD = 10%, $f = 1\text{ kHz}$ , $A_V = 46\text{ dB}$	4	4.5		W
Total Harmonic Distortion	$P_{OUT} = 50\text{ mW}$ , $f = 1\text{ kHz}$ , $A_V = 46\text{ dB}$		0.3		%
	$P_{OUT} = 2\text{ W}$ , $f = 1\text{ kHz}$ , $A_V = 46\text{ dB}$		0.8		%
Equivalent Input Noise Voltage	$R_S = 22\text{ k}\Omega$ , BW = 10 kHz		3.4		$\mu\text{V}$
Total Supply Current	$P_{OUT} = 4.5\text{ W}$		485		mA
Internal Feedback Resistors (see equivalent circuit)	R6		7		k $\Omega$
	R3		35		$\Omega$
Input Impedance (Pin 7)	$A_V = 46\text{ dB}$ , $f = 1\text{ kHz}$		3		M $\Omega$

TBA641 A12

**ELECTRICAL CHARACTERISTICS**  $V_+ = 9\text{ V}$ ,  $R_L = 4\ \Omega$ ,  $T_A = 25^\circ\text{C}$  unless otherwise specified. (See Test Circuit)

CHARACTERISTICS	CONDITIONS	MIN	TYP	MAX	UNITS
Total Supply Current	$P_{OUT} = 0$		8	18	mA
Quiescent Current of Output Transistors	$P_{OUT} = 0$		6		mA
Input Bias Current (Pin 7)			100		nA
DC Output Level (Pin 1)		4	4.5	5	V
Voltage Gain	$R_f = 0\ \Omega$		46		dB
Output Power	THD = 10%, $f = 1\text{ kHz}$ , $A_V = 46\text{ dB}$	1.8	2.2		W
Total Harmonic Distortion	$P_{OUT} = 50\text{ mW}$ , $f = 1\text{ kHz}$ , $A_V = 46\text{ dB}$		0.6		%
	$P_{OUT} = 1\text{ W}$ , $f = 1\text{ kHz}$ , $A_V = 46\text{ dB}$		0.6		%
Equivalent Input Noise Voltage	$R_S = 22\text{ k}\Omega$ , BW = 10 kHz		2.5		$\mu\text{V}$
Total Supply Current	$P_{OUT} = 2.2\text{ W}$		340		mA
Internal Feedback Resistors (see equivalent circuit)	R6		7		k $\Omega$
	R3		35		$\Omega$
Input Impedance (Pin 7)	$A_V = 46\text{ dB}$ , $f = 1\text{ kHz}$		3		M $\Omega$

TYPICAL PERFORMANCE CURVES FOR TBA641 B11

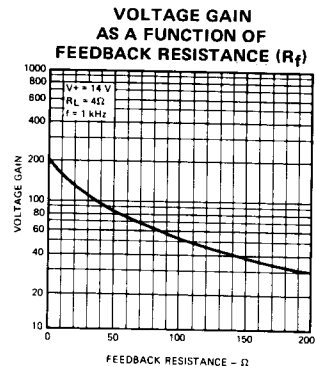
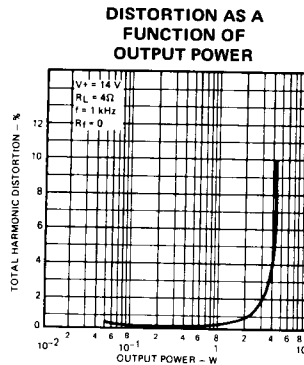
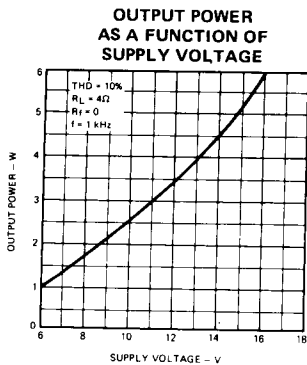

TYPICAL PERFORMANCE CURVES FOR TBA641 B11 (Cont'd)

**$C_b$  AS A FUNCTION OF  $R_f$  FOR VARIOUS VALUES OF BANDWIDTH**

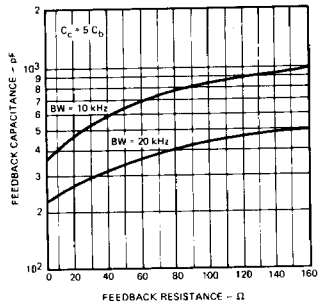

**OUTPUT POWER AS A FUNCTION OF INPUT VOLTAGE**

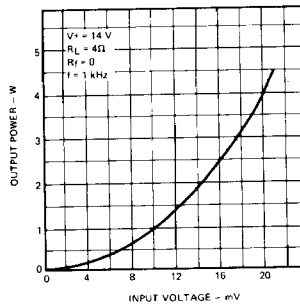

**POWER DISSIPATION AND EFFICIENCY AS A FUNCTION OF OUTPUT POWER**

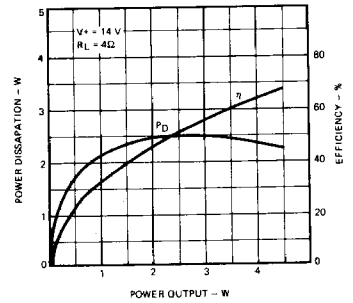

**SUPPLY CURRENT AS A FUNCTION OF OUTPUT POWER**

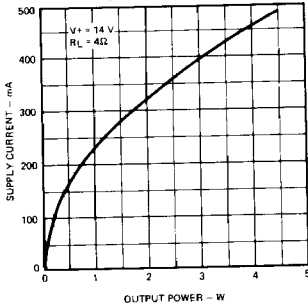

**MAXIMUM POWER DISSIPATION AS A FUNCTION OF SUPPLY VOLTAGE**

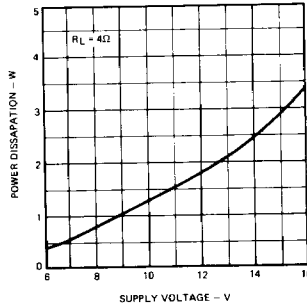

**POWER RATING CHART**

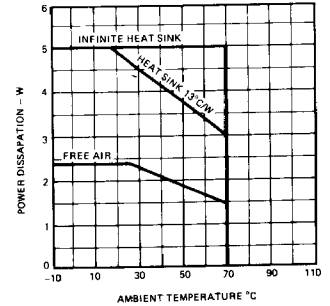

**QUIESCENT SUPPLY CURRENT AS A FUNCTION OF SUPPLY VOLTAGE**

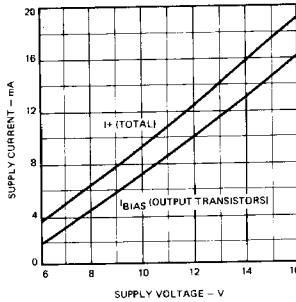

**QUIESCENT SUPPLY CURRENT AS A FUNCTION OF AMBIENT TEMPERATURE**

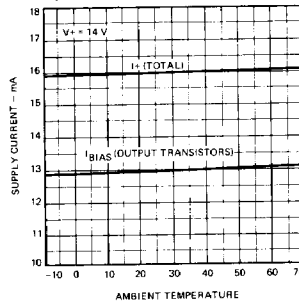

**QUIESCENT OUTPUT VOLTAGE AS A FUNCTION OF AMBIENT TEMPERATURE**

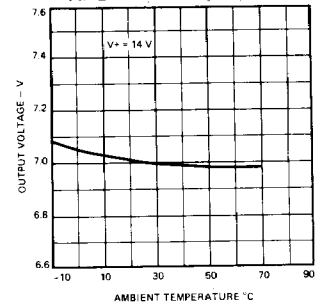

**QUIESCENT OUTPUT VOLTAGE AS A FUNCTION OF SUPPLY VOLTAGE**

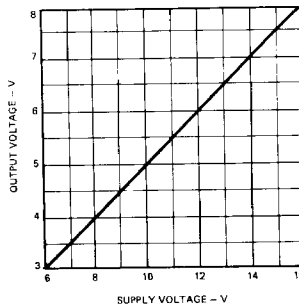

TYPICAL PERFORMANCE CURVES FOR TBA641 A12

OUTPUT POWER AS A FUNCTION OF SUPPLY VOLTAGE

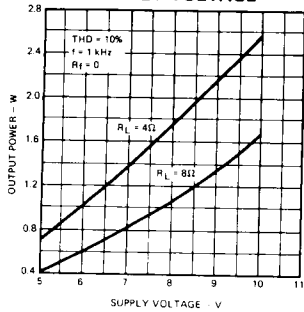

DISTORTION AS A FUNCTION OF OUTPUT POWER

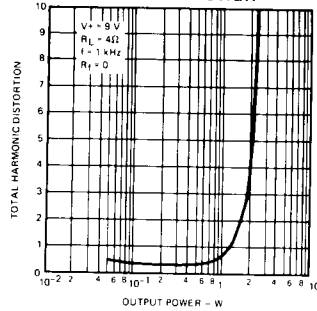

VOLTAGE GAIN AS A FUNCTION OF FEEDBACK RESISTANCE (Rf)

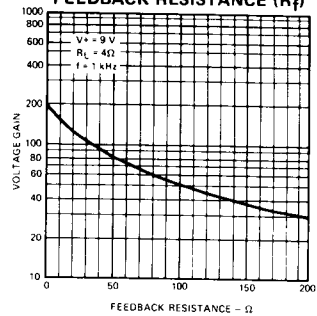

Cb AS A FUNCTION OF Rf FOR VARIOUS VALUES OF BANDWIDTH

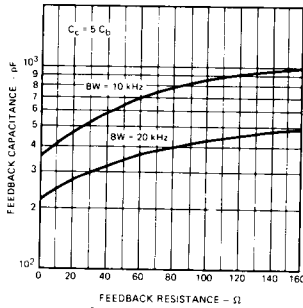

OUTPUT POWER AS A FUNCTION OF INPUT VOLTAGE

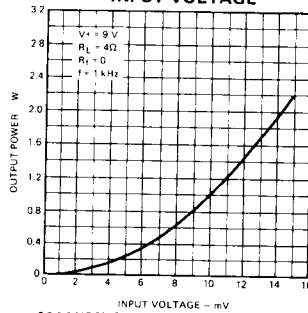

POWER DISSIPATION AND EFFICIENCY AS A FUNCTION OF OUTPUT POWER

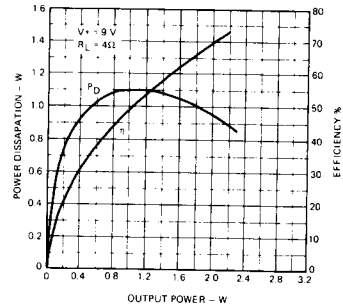

SUPPLY CURRENT AS A FUNCTION OF OUTPUT POWER

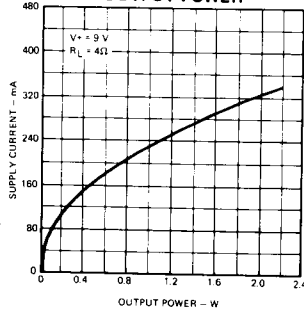

MAXIMUM POWER DISSIPATION AS A FUNCTION OF SUPPLY VOLTAGE

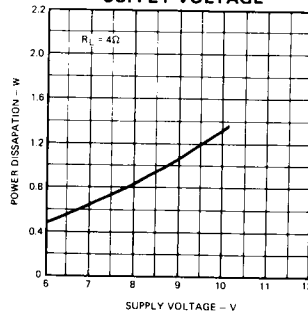

POWER RATING CHART

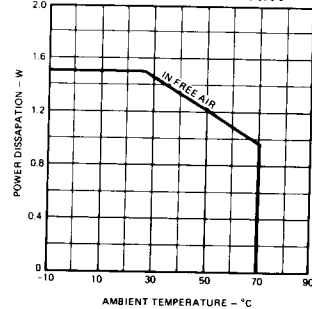

QUIESCENT SUPPLY CURRENT AS A FUNCTION OF SUPPLY VOLTAGE

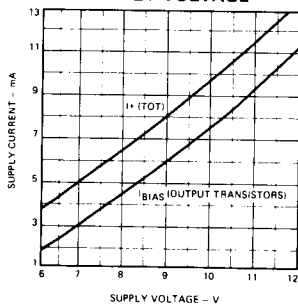

QUIESCENT SUPPLY CURRENT AS A FUNCTION OF AMBIENT TEMPERATURE

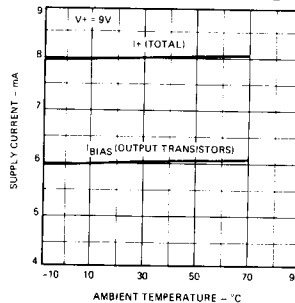

4

TYPICAL PERFORMANCE CURVES FOR TBA641 A12 (Cont'd)

QUIESCENT OUTPUT VOLTAGE AS A FUNCTION OF AMBIENT TEMPERATURE

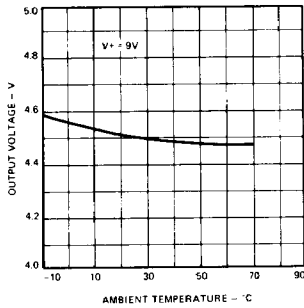

QUIESCENT OUTPUT VOLTAGE AS A FUNCTION OF SUPPLY VOLTAGE

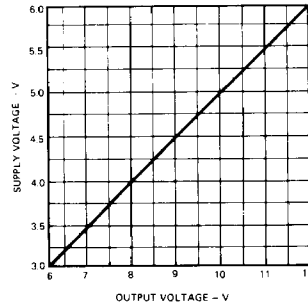

TEST AND APPLICATION CIRCUIT - TBA641

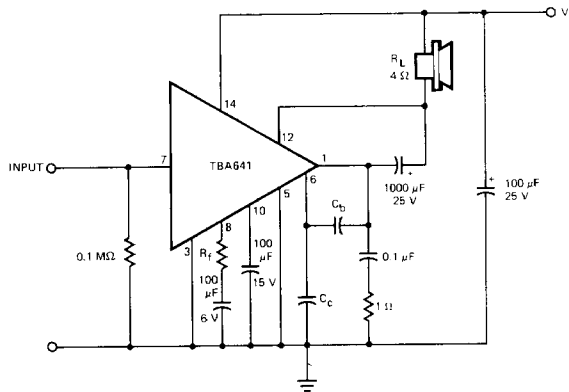

AM CAR RADIO APPLICATION TBA641 B11

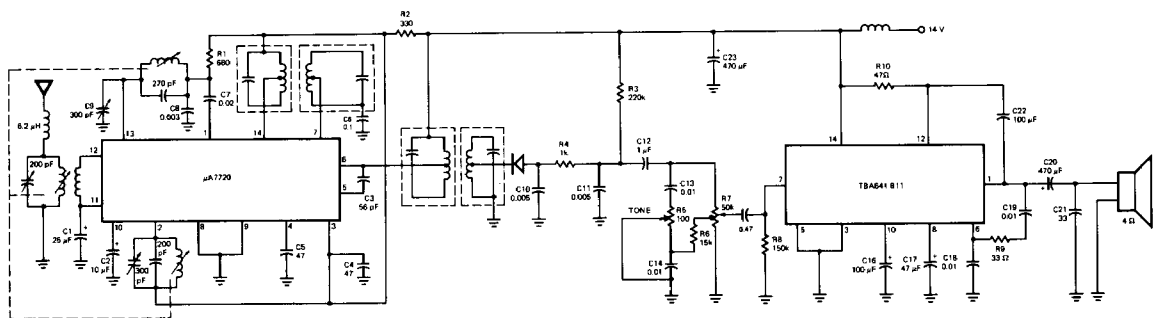

ELECTRICAL PERFORMANCE

Output power (THD = 10%)	4.5 W
Useable sensitivity (S/N = 20 dB)	10 μV
S/N (5 mV Input)	40 dB
AGC Range (ΔV <sub>OUT</sub> = 10 dB)	80 dB

**MOUNTING INSTRUCTIONS – TBA641 B11** Power dissipation can be increased by means of an additional external heat sink fixed with two screws or by soldering the pins of the external bar to suitable copper areas on the PC board (TBA641 B11).

A. In the former case, the thermal resistance case-ambient of the added heat sink can be calculated as follows:

$$\theta_{C-A} = \frac{(T_{J(MAX)} - T_A) - (P_D) (\theta_{J-C})}{P_D}$$

where:

$T_{J(MAX)}$  = Max junction temperature

$T_A$  = Ambient temperature

$P_D$  = Power dissipation

$\theta_{J-C}$  = Thermal resistance junction to case

B. If copper areas on the PC board are used (TBA641 B11) the diagrams below give the maximum power dissipation as a function of copper area, with copper thickness 35  $\mu$  and ambient temperature 55° C.

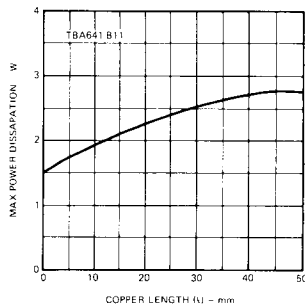
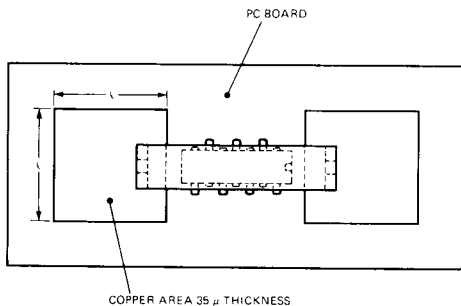

This datasheet has been downloaded from:

[www.DatasheetCatalog.com](http://www.DatasheetCatalog.com)

Datasheets for electronic components.