

RoHS compliant

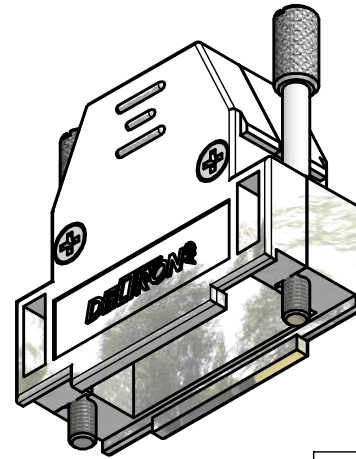
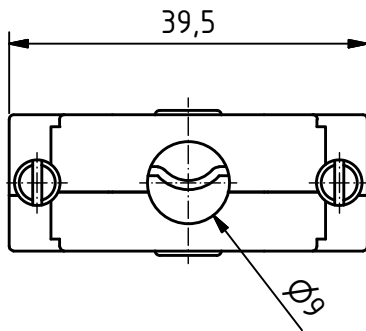
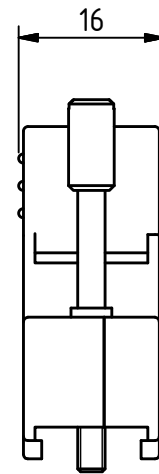
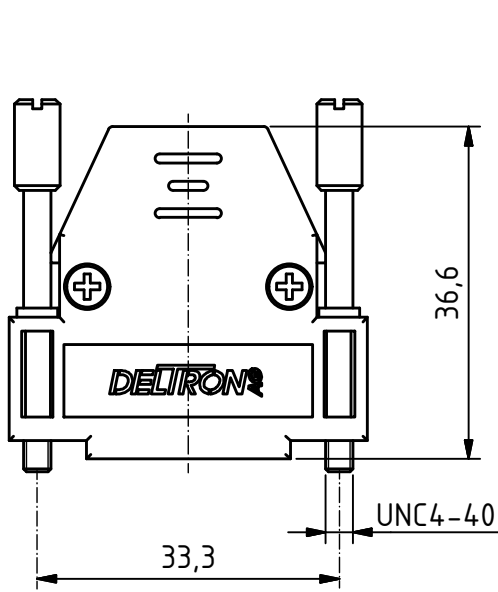

MATERIALS

- Hood: thermoplastic metallized

CHARACTERISTICS

- Temperature range: -40°C to +85°C
- Housing screw: with pressed in grommet
- Straight cable outlet
- Preassembled metal strain relief
- Two mobile assembled screws
- Attenuation: min. 40 db at 100Mhz

-Set packed in bag

General tolerances (Deltron standard)			
size in mm			
> 0.5	> 3	> 6	> 30
up to 3	up to 6	up to 30	up to 120
Tolerances			
±0.1	±0.2	±0.2	±0.3

modification	Rev.	Rev.	Rev.	DE001669 part no.		
	Rev.	Rev.	Rev.			
CTLM15UN4	1.2:1 scale	drawn	08.04.2015	mw		
		checked				
		approved				
 Industrie Neuhof 8c CH-3422 Kirchberg		K061940 drawing no.				