

## LMC6082 Precision CMOS Dual Operational Amplifier

### General Description

The LMC6082 is a precision dual low offset voltage operational amplifier, capable of single supply operation. Performance characteristics include ultra low input bias current, high voltage gain, rail-to-rail output swing, and an input common mode voltage range that includes ground. These features, plus its low offset voltage, make the LMC6082 ideally suited for precision circuit applications.

Other applications using the LMC6082 include precision full-wave rectifiers, integrators, references, and sample-and-hold circuits.

This device is built with National's advanced Double-Poly Silicon-Gate CMOS process.

For designs with more critical power demands, see the LMC6062 precision dual micropower operational amplifier.

### Features (Typical unless otherwise stated)

- Low offset voltage 150  $\mu$ V
- Operates from 4.5V to 15V single supply
- Ultra low input bias current 10 fA
- Output swing to within 20 mV of supply rail, 100k load
- Input common-mode range includes  $V^-$
- High voltage gain 130 dB
- Improved latchup immunity

### Applications

- Instrumentation amplifier
- Photodiode and infrared detector preamplifier
- Transducer amplifiers
- Medical instrumentation
- D/A converter
- Charge amplifier for piezoelectric transducers

**PATENT PENDING**

### Connection Diagram

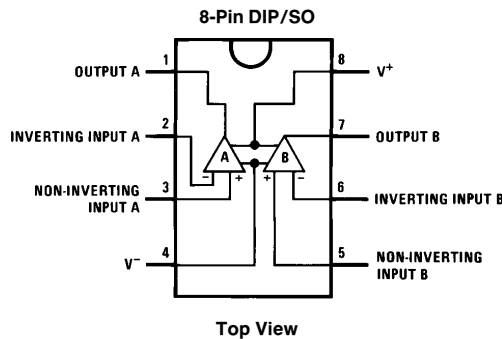

### Ordering Information

Package	Temperature Range		NSC Drawing	Transport Media
	Military -55°C to +125°C	Industrial -40°C to +85°C		
8-Pin Molded DIP	LMC6082AMN	LMC6082AIN LMC6082IN	N08E	Rail
8-Pin Small Outline		LMC6082AIM LMC6082IM	M08A	Rail Tape and Reel

**For MIL-STD-883C qualified products, please contact your local National Semiconductor Sales Office or Distributor for availability and specification information.**

## Absolute Maximum Ratings (Note 1)

If Military/Aerospace specified devices are required, please contact the National Semiconductor Sales Office/Distributors for availability and specifications.

Differential Input Voltage	$\pm$ Supply Voltage
Voltage at Input/Output Pin	(V <sup>+</sup> ) +0.3V, (V <sup>-</sup> ) -0.3V
Supply Voltage (V <sup>+</sup> - V <sup>-</sup> )	16V
Output Short Circuit to V <sup>+</sup>	(Note 11)
Output Short Circuit to V <sup>-</sup>	(Note 2)
Lead Temperature (Soldering, 10 Sec.)	260°C
Storage Temp. Range	-65°C to +150°C
Junction Temperature	150°C
ESD Tolerance (Note 4)	2 kV

Current at Input Pin	$\pm$ 10 mA
Current at Output Pin	$\pm$ 30 mA
Current at Power Supply Pin	40 mA
Power Dissipation	(Note 3)

## Operating Ratings (Note 1)

Temperature Range	
LMC6082AM	-55°C $\leq$ T <sub>J</sub> $\leq$ +125°C
LMC6082AI, LMC6082I	-40°C $\leq$ T <sub>J</sub> $\leq$ +85°C
Supply Voltage	4.5V $\leq$ V <sup>+</sup> $\leq$ 15.5V
Thermal Resistance ( $\theta_{JA}$ ) (Note 12)	
8-Pin Molded DIP	115°C/W
8-Pin SO	193°C/W
Power Dissipation	(Note 10)

## DC Electrical Characteristics

Unless otherwise specified, all limits guaranteed for T<sub>J</sub> = 25°C. **Boldface** limits apply at the temperature extremes. V<sup>+</sup> = 5V, V<sup>-</sup> = 0V, V<sub>CM</sub> = 1.5V, V<sub>O</sub> = 2.5V and R<sub>L</sub> > 1M unless otherwise specified.

Symbol	Parameter	Conditions	Typ (Note 5)	LMC6082AM Limit (Note 6)	LMC6082AI Limit (Note 6)	LMC6082I Limit (Note 6)	Units	
V <sub>OS</sub>	Input Offset Voltage		150	350 <b>1000</b>	350 <b>800</b>	800 <b>1300</b>	$\mu$ V Max	
TCV <sub>OS</sub>	Input Offset Voltage Average Drift		1.0				$\mu$ V/°C	
I <sub>B</sub>	Input Bias Current		0.010	<b>100</b>	<b>4</b>	<b>4</b>	pA Max	
I <sub>OS</sub>	Input Offset Current		0.005	<b>100</b>	<b>2</b>	<b>2</b>	pA Max	
R <sub>IN</sub>	Input Resistance		> 10				Tera $\Omega$	
CMRR	Common Mode Rejection Ratio	0V $\leq$ V <sub>CM</sub> $\leq$ 12.0V V <sup>+</sup> = 15V	85	75 <b>72</b>	75 <b>72</b>	66 <b>63</b>	dB Min	
+ PSRR	Positive Power Supply Rejection Ratio	5V $\leq$ V <sup>+</sup> $\leq$ 15V V <sub>O</sub> = 2.5V	85	75 <b>72</b>	75 <b>72</b>	66 <b>63</b>	dB Min	
- PSRR	Negative Power Supply Rejection Ratio	0V $\leq$ V <sup>-</sup> $\leq$ -10V	94	84 <b>81</b>	84 <b>81</b>	74 <b>71</b>	dB Min	
V <sub>CM</sub>	Input Common-Mode Voltage Range	V <sup>+</sup> = 5V and 15V for CMRR $\geq$ 60 dB	-0.4	-0.1 <b>0</b>	-0.1 <b>0</b>	-0.1 <b>0</b>	V Max	
			V <sup>+</sup> - 1.9	V <sup>+</sup> - 2.3 <b>V<sup>+</sup> - 2.6</b>	V <sup>+</sup> - 2.3 <b>V<sup>+</sup> - 2.5</b>	V <sup>+</sup> - 2.3 <b>V<sup>+</sup> - 2.5</b>	V Min	
A <sub>v</sub>	Large Signal Voltage Gain	R <sub>L</sub> = 2 k $\Omega$ (Note 7)	Sourcing	1400	400 <b>300</b>	400 <b>300</b>	300 <b>200</b>	V/mV Min
			Sinking	350	180 <b>70</b>	180 <b>100</b>	90 <b>60</b>	V/mV Min
		R <sub>L</sub> = 600 $\Omega$ (Note 7)	Sourcing	1200	400 <b>150</b>	400 <b>150</b>	200 <b>80</b>	V/mV Min
			Sinking	150	100 <b>35</b>	100 <b>50</b>	70 <b>35</b>	V/mV Min

### DC Electrical Characteristics (Continued)

Unless otherwise specified, all limits guaranteed for  $T_J = 25^\circ\text{C}$ . **Boldface** limits apply at the temperature extremes.  $V^+ = 5\text{V}$ ,  $V^- = 0\text{V}$ ,  $V_{CM} = 1.5\text{V}$ ,  $V_O = 2.5\text{V}$  and  $R_L > 1\text{M}$  unless otherwise specified.

Symbol	Parameter	Conditions	Typ (Note 5)	LMC6082AM Limit (Note 6)	LMC6082AI Limit (Note 6)	LMC6082I Limit (Note 6)	Units		
$V_O$	Output Swing	$V^+ = 5\text{V}$ $R_L = 2\text{ k}\Omega$ to $2.5\text{V}$	4.87	4.80 <b>4.70</b>	4.80 <b>4.73</b>	4.75 <b>4.67</b>	V Min		
			0.10	0.13 <b>0.19</b>	0.13 <b>0.17</b>	0.20 <b>0.24</b>	V Max		
		$V^+ = 5\text{V}$ $R_L = 600\Omega$ to $2.5\text{V}$	4.61	4.50 <b>4.24</b>	4.50 <b>4.31</b>	4.40 <b>4.21</b>	V Min		
			0.30	0.40 <b>0.63</b>	0.40 <b>0.50</b>	0.50 <b>0.63</b>	V Max		
		$V^+ = 15\text{V}$ $R_L = 2\text{ k}\Omega$ to $7.5\text{V}$	14.63	14.50 <b>14.30</b>	14.50 <b>14.34</b>	14.37 <b>14.25</b>	V Min		
			0.26	0.35 <b>0.48</b>	0.35 <b>0.45</b>	0.44 <b>0.56</b>	V Max		
		$V^+ = 15\text{V}$ $R_L = 600\Omega$ to $7.5\text{V}$	13.90	13.35 <b>12.80</b>	13.35 <b>12.86</b>	12.92 <b>12.44</b>	V Min		
			0.79	1.16 <b>1.42</b>	1.16 <b>1.32</b>	1.33 <b>1.58</b>	V Max		
		$I_O$	Output Current $V^+ = 5\text{V}$	Sourcing, $V_O = 0\text{V}$	22	16 <b>8</b>	16 <b>10</b>	13 <b>8</b>	mA Min
				Sinking, $V_O = 5\text{V}$	21	16 <b>11</b>	16 <b>13</b>	13 <b>10</b>	mA Min
$I_O$	Output Current $V^+ = 15\text{V}$	Sourcing, $V_O = 0\text{V}$	30	28 <b>18</b>	28 <b>22</b>	23 <b>18</b>	mA Min		
		Sinking, $V_O = 13\text{V}$ (Note 11)	34	28 <b>19</b>	28 <b>22</b>	23 <b>18</b>	mA Min		
$I_S$	Supply Current	Both Amplifiers $V^+ = +5\text{V}$ , $V_O = 1.5\text{V}$	0.9	1.5 <b>1.8</b>	1.5 <b>1.8</b>	1.5 <b>1.8</b>	mA Max		
		Both Amplifiers $V^+ = +15\text{V}$ , $V_O = 7.5\text{V}$	1.1	1.7 <b>2</b>	1.7 <b>2</b>	1.7 <b>2</b>	mA Max		

## AC Electrical Characteristics

Unless otherwise specified, all limits guaranteed for  $T_J = 25^\circ\text{C}$ , **Boldface** limits apply at the temperature extremes.  $V^+ = 5\text{V}$ ,  $V^- = 0\text{V}$ ,  $V_{\text{CM}} = 1.5\text{V}$ ,  $V_O = 2.5\text{V}$  and  $R_L > 1\text{M}$  unless otherwise specified.

Symbol	Parameter	Conditions	Typ (Note 5)	LMC6082AM Limit (Note 6)	LMC6082AI Limit (Note 6)	LMC6082I Limit (Note 6)	Units
SR	Slew Rate	(Note 8)	1.5	0.8 <b>0.5</b>	0.8 <b>0.6</b>	0.8 <b>0.6</b>	V/ $\mu\text{s}$ Min
GBW	Gain-Bandwidth Product		1.3				MHz
$\phi_m$	Phase Margin		50				Deg
	Amp-to-Amp Isolation	(Note 9)	140				dB
$e_n$	Input-Referred Voltage Noise	F = 1 kHz	22				nV/ $\sqrt{\text{Hz}}$
$i_n$	Input-Referred Current Noise	F = 1 kHz	0.0002				pA/ $\sqrt{\text{Hz}}$
T.H.D.	Total Harmonic Distortion	F = 10 kHz, $A_V = -10$ $R_L = 2\text{ k}\Omega$ , $V_O = 8\text{ V}_{\text{pp}}$ $\pm 5\text{V}$ Supply	0.01				%

**Note 1:** Absolute Maximum Ratings indicate limits beyond which damage to the device may occur. Operating Ratings indicate conditions for which the device is intended to be functional, but do not guarantee specific performance limits. For guaranteed specifications and test conditions, see the Electrical Characteristics. The guaranteed specifications apply only for the test conditions listed.

**Note 2:** Applies to both single-supply and split-supply operation. Continuous short circuit operation at elevated ambient temperature can result in exceeding the maximum allowed junction temperature of  $150^\circ\text{C}$ . Output currents in excess of  $\pm 30\text{ mA}$  over long term may adversely affect reliability.

**Note 3:** The maximum power dissipation is a function of  $T_{\text{J(Max)}}$ ,  $\theta_{\text{JA}}$ , and  $T_A$ . The maximum allowable power dissipation at any ambient temperature is  $P_D = (T_{\text{J(Max)}} - T_A) / \theta_{\text{JA}}$ .

**Note 4:** Human body model,  $1.5\text{ k}\Omega$  in series with  $100\text{ pF}$ .

**Note 5:** Typical values represent the most likely parametric norm.

**Note 6:** All limits are guaranteed by testing or statistical analysis.

**Note 7:**  $V^+ = 15\text{V}$ ,  $V_{\text{CM}} = 7.5\text{V}$  and  $R_L$  connected to  $7.5\text{V}$ . For Sourcing tests,  $7.5\text{V} \leq V_O \leq 11.5\text{V}$ . For Sinking tests,  $2.5\text{V} \leq V_O \leq 7.5\text{V}$ .

**Note 8:**  $V^+ = 15\text{V}$ . Connected as Voltage Follower with  $10\text{V}$  step input. Number specified is the slower of the positive and negative slew rates.

**Note 9:** Input referred  $V^+ = 15\text{V}$  and  $R_L = 100\text{ k}\Omega$  connected to  $7.5\text{V}$ . Each amp excited in turn with  $1\text{ kHz}$  to produce  $V_O = 12\text{ V}_{\text{pp}}$ .

**Note 10:** For operating at elevated temperatures the device must be derated based on the thermal resistance  $\theta_{\text{JA}}$  with  $P_D = (T_J - T_A) / \theta_{\text{JA}}$ . All numbers apply for packages soldered directly into a PC board.

**Note 11:** Do not connect output to  $V^+$ , when  $V^+$  is greater than  $13\text{V}$  or reliability will be adversely affected.

**Note 12:** All numbers apply for packages soldered directly into a PC board.

# Typical Performance Characteristics $V_S = \pm 7.5V$ , $T_A = 25^\circ C$ , Unless otherwise specified

**Distribution of LMC6082 Input Offset Voltage ( $T_A = +25^\circ C$ )**

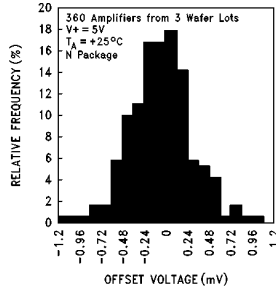

**Distribution of LMC6082 Input Offset Voltage ( $T_A = -55^\circ C$ )**

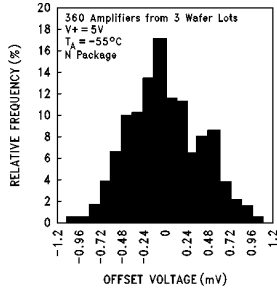

**Distribution of LMC6082 Input Offset Voltage ( $T_A = +125^\circ C$ )**

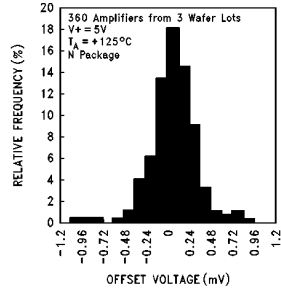

**Input Bias Current vs Temperature**

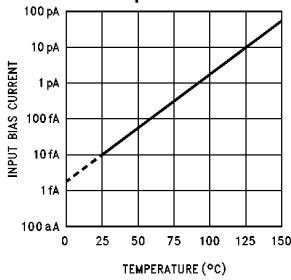

**Supply Current vs Supply Voltage**

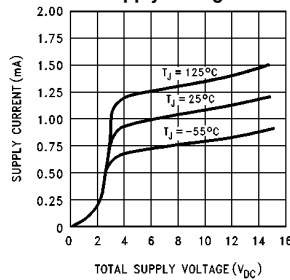

**Input Voltage vs Output Voltage**

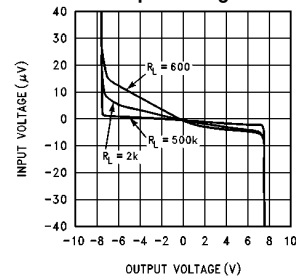

**Common Mode Rejection Ratio vs Frequency**

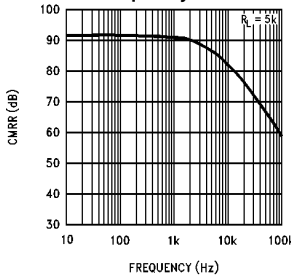

**Power Supply Rejection Ratio vs Frequency**

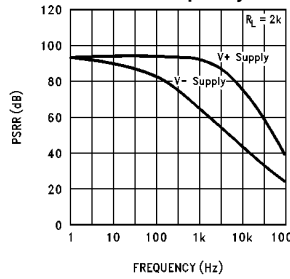

**Input Voltage Noise vs Frequency**

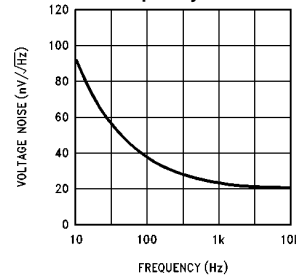

**Output Characteristics Sourcing Current**

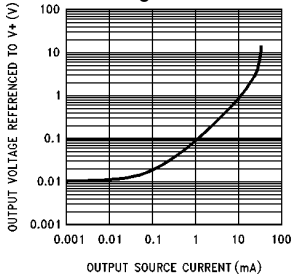

**Output Characteristics Sinking Current**

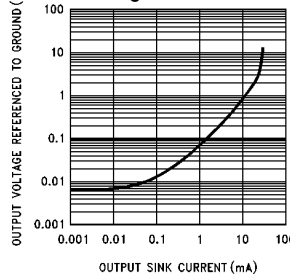

**Gain and Phase Response vs Temperature ( $-55^\circ C$  to  $+125^\circ C$ )**

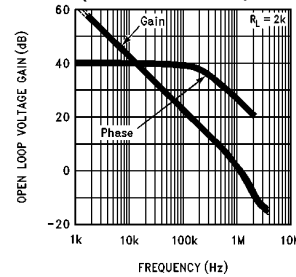

TL/H/11297-2

**Typical Performance Characteristics**  $V_S = \pm 7.5V$ ,  $T_A = 25^\circ C$ , Unless otherwise specified

**Gain and Phase Response vs Capacitive Load with  $R_L = 600\Omega$**

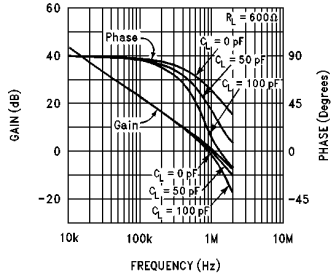

**Gain and Phase Response vs Capacitive Load with  $R_L = 500k\Omega$**

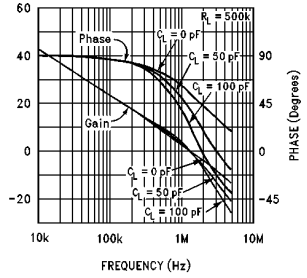

**Open Loop Frequency Response**

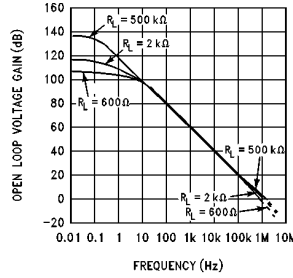

**Inverting Small Signal Pulse Response**

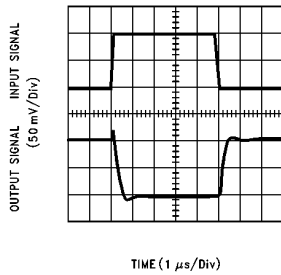

**Inverting Large Signal Pulse Response**

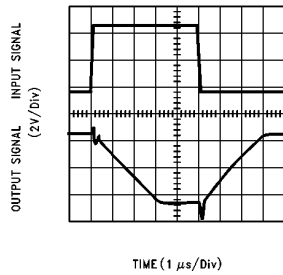

**Non-Inverting Small Signal Pulse Response**

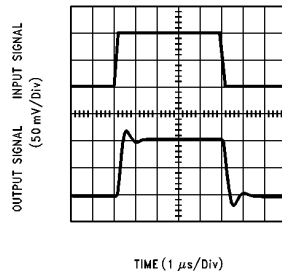

**Non-Inverting Large Signal Pulse Response**

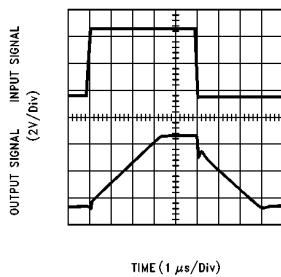

**Crosstalk Rejection vs Frequency**

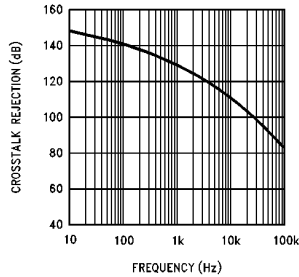

**Stability vs Capacitive Load,  $R_L = 600\Omega$**

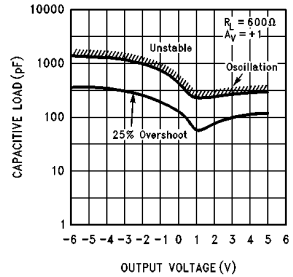

**Stability vs Capacitive Load  $R_L = 1M\Omega$**

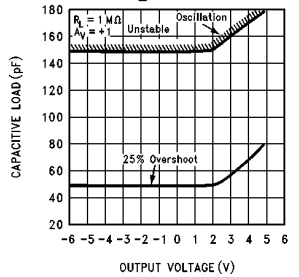

## Applications Hints

### AMPLIFIER TOPOLOGY

The LMC6082 incorporates a novel op-amp design topology that enables it to maintain rail to rail output swing even when driving a large load. Instead of relying on a push-pull unity gain output buffer stage, the output stage is taken directly from the internal integrator, which provides both low output impedance and large gain. Special feed-forward compensation design techniques are incorporated to maintain stability over a wider range of operating conditions than traditional micropower op-amps. These features make the LMC6082 both easier to design with, and provide higher speed than products typically found in this ultra-low power class.

### COMPENSATING FOR INPUT CAPACITANCE

It is quite common to use large values of feedback resistance for amplifiers with ultra-low input current, like the LMC6082.

Although the LMC6082 is highly stable over a wide range of operating conditions, certain precautions must be met to achieve the desired pulse response when a large feedback resistor is used. Large feedback resistors and even small values of input capacitance, due to transducers, photodiodes, and circuit board parasitics, reduce phase margins.

When high input impedances are demanded, guarding of the LMC6082 is suggested. Guarding input lines will not only reduce leakage, but lowers stray input capacitance as well. (See *Printed-Circuit-Board Layout for High Impedance Work*).

The effect of input capacitance can be compensated for by adding a capacitor,  $C_f$ , around the feedback resistors (as in *Figure 1*) such that:

$$\frac{1}{2\pi R_1 C_{IN}} \geq \frac{1}{2\pi R_2 C_f}$$

or

$$R_1 C_{IN} \leq R_2 C_f$$

Since it is often difficult to know the exact value of  $C_{IN}$ ,  $C_f$  can be experimentally adjusted so that the desired pulse response is achieved. Refer to the LMC660 and LMC662 for a more detailed discussion on compensating for input capacitance.

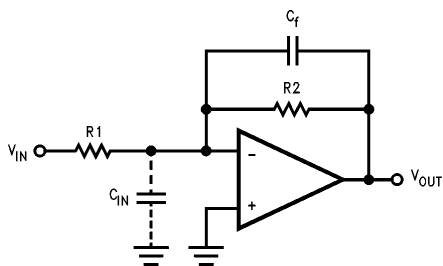

TL/H/11297-4

FIGURE 1. Cancelling the Effect of Input Capacitance

### CAPACITIVE LOAD TOLERANCE

All rail-to-rail output swing operational amplifiers have voltage gain in the output stage. A compensation capacitor is normally included in this integrator stage. The frequency location of the dominant pole is affected by the resistive load on the amplifier. Capacitive load driving capability can be optimized by using an appropriate resistive load in parallel with the capacitive load (see typical curves).

Direct capacitive loading will reduce the phase margin of many op-amps. A pole in the feedback loop is created by the combination of the op-amp's output impedance and the capacitive load. This pole induces phase lag at the unity-gain crossover frequency of the amplifier resulting in either an oscillatory or underdamped pulse response. With a few external components, op amps can easily indirectly drive capacitive loads, as shown in *Figure 2a*.

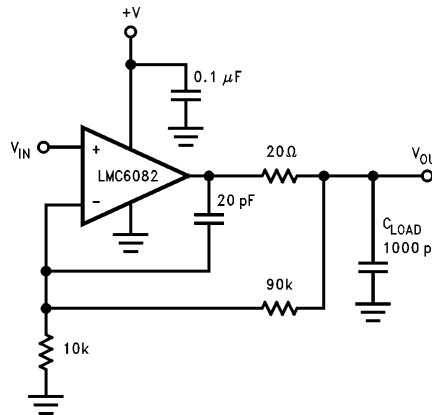

TL/H/11297-5

FIGURE 2a. LMC6082 Noninverting Gain of 10 Amplifier, Compensated to Handle Capacitive Loads

In the circuit of *Figure 2a*,  $R_1$  and  $C_1$  serve to counteract the loss of phase margin by feeding the high frequency component of the output signal back to the amplifier's inverting input, thereby preserving phase margin in the overall feedback loop.

Capacitive load driving capability is enhanced by using a pull up resistor to  $V^+$  (*Figure 2b*). Typically a pull up resistor conducting  $500 \mu A$  or more will significantly improve capacitive load responses. The value of the pull up resistor must be determined based on the current sinking capability of the amplifier with respect to the desired output swing. Open loop gain of the amplifier can also be affected by the pull up resistor (see Electrical Characteristics).

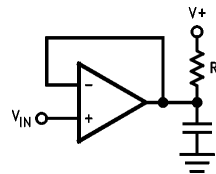

TL/H/11297-14

FIGURE 2b. Compensating for Large Capacitive Loads with a Pull Up Resistor

### PRINTED-CIRCUIT-BOARD LAYOUT FOR HIGH-IMPEDANCE WORK

It is generally recognized that any circuit which must operate with less than  $1000 \text{ pA}$  of leakage current requires special layout of the PC board. When one wishes to take advantage of the ultra-low bias current of the LMC6082, typically less than  $10 \text{ fA}$ , it is essential to have an excellent layout. Fortunately, the techniques of obtaining low leakages are quite simple. First, the user must not ignore the surface

## Applications Hints

leakage of the PC board, even though it may sometimes appear acceptably low, because under conditions of high humidity or dust or contamination, the surface leakage will be appreciable.

To minimize the effect of any surface leakage, lay out a ring of foil completely surrounding the LMC6082's inputs and the terminals of capacitors, diodes, conductors, resistors, relay terminals, etc. connected to the op-amp's inputs, as in *Figure 3*. To have a significant effect, guard rings should be placed on both the top and bottom of the PC board. This PC foil must then be connected to a voltage which is at the same voltage as the amplifier inputs, since no leakage current can flow between two points at the same potential. For example, a PC board trace-to-pad resistance of  $10^{12}\Omega$ , which is normally considered a very large resistance, could leak 5 pA if the trace were a 5V bus adjacent to the pad of the input. This would cause a 100 times degradation from the LMC6082's actual performance. However, if a guard ring is held within 5 mV of the inputs, then even a resistance of  $10^{11}\Omega$  would cause only 0.05 pA of leakage current. See *Figures 4a, 4b, 4c* for typical connections of guard rings for standard op-amp configurations.

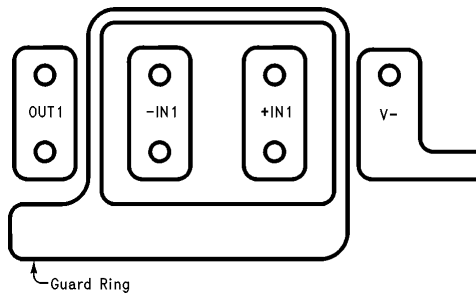

TL/H/11297-6

**FIGURE 3. Example of Guard Ring in P.C. Board Layout**

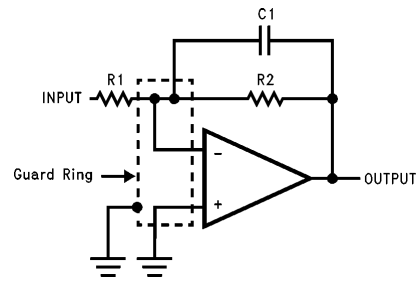

TL/H/11297-7

**(a) Inverting Amplifier**

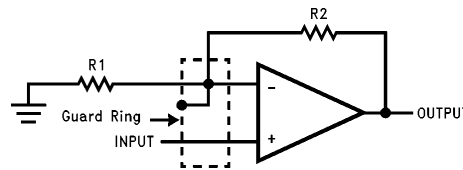

TL/H/11297-8

**(b) Non-Inverting Amplifier**

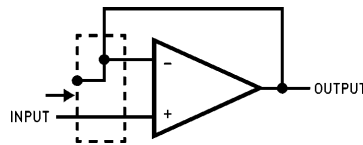

TL/H/11297-9

**(c) Follower**

**FIGURE 4. Typical Connections of Guard Rings**

The designer should be aware that when it is inappropriate to lay out a PC board for the sake of just a few circuits, there is another technique which is even better than a guard ring on a PC board: Don't insert the amplifier's input pin into the board at all, but bend it up in the air and use only air as an insulator. Air is an excellent insulator. In this case you may have to forego some of the advantages of PC board construction, but the advantages are sometimes well worth the effort of using point-to-point up-in-the-air wiring. See *Figure 5*.



## Latchup

CMOS devices tend to be susceptible to latchup due to their internal parasitic SCR effects. The (I/O) input and output pins look similar to the gate of the SCR. There is a minimum current required to trigger the SCR gate lead. The LMC6062 and LMC6082 are designed to withstand 100 mA surge current on the I/O pins. Some resistive method should be used to isolate any capacitance from supplying excess current to the I/O pins. In addition, like an SCR, there is a minimum holding current for any latchup mode. Limiting current to the supply pins will also inhibit latchup susceptibility.

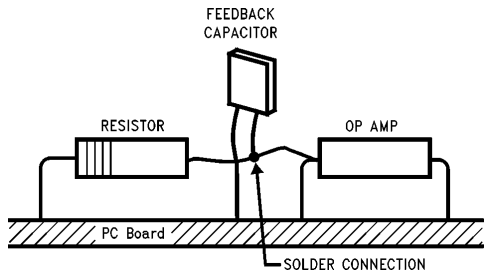

TL/H/11297-10

(Input pins are lifted out of PC board and soldered directly to components. All other pins connected to PC board).

**FIGURE 5. Air Wiring**

## Typical Single-Supply Applications

( $V^+ = 5.0 V_{DC}$ )

The extremely high input impedance, and low power consumption, of the LMC6082 make it ideal for applications that require battery-powered instrumentation amplifiers. Examples of these types of applications are hand-held pH probes, analytic medical instruments, magnetic field detectors, gas detectors, and silicon based pressure transducers.

Figure 6 shows an instrumentation amplifier that features high differential and common mode input resistance ( $> 10^{14} \Omega$ ), 0.01% gain accuracy at  $A_V = 1000$ , excellent CMRR with 1 k $\Omega$  imbalance in bridge source resistance. Input current is less than 100 fA and offset drift is less than 2.5  $\mu V/^\circ C$ .  $R_2$  provides a simple means of adjusting gain over a wide range without degrading CMRR.  $R_7$  is an initial trim used to maximize CMRR without using super precision matched resistors. For good CMRR over temperature, low drift resistors should be used.

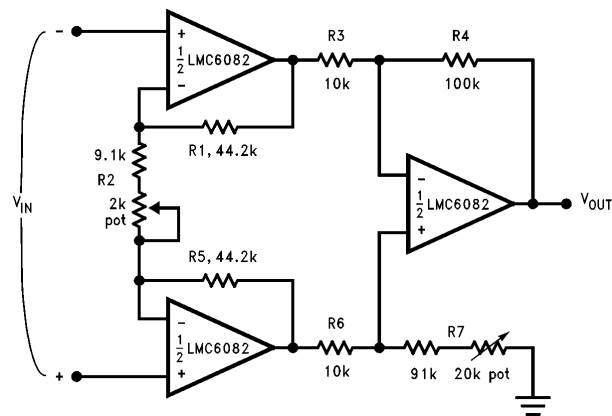

TL/H/11297-11

If  $R_1 = R_5$ ,  $R_3 = R_6$ , and  $R_4 = R_7$ ; then

$$\frac{V_{OUT}}{V_{IN}} = \frac{R_2 + 2R_1}{R_2} \times \frac{R_4}{R_3}$$

$\therefore A_V \approx 100$  for circuit shown ( $R_2 = 9.822k$ ).

**FIGURE 6. Instrumentation Amplifier**

**Typical Single-Supply Applications** ( $V^+ = 5.0 V_{DC}$ )

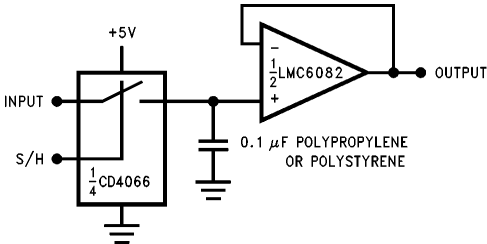

**FIGURE 7. Low-Leakage Sample and Hold**

TL/H/11297-12

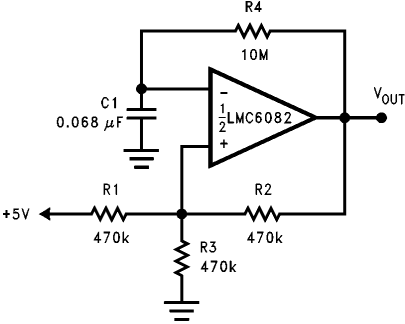

**FIGURE 8. 1 Hz Square Wave Oscillator**

TL/H/11297-13

**Physical Dimensions** inches (millimeters)

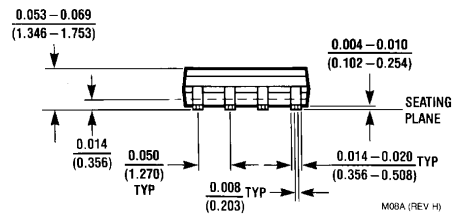
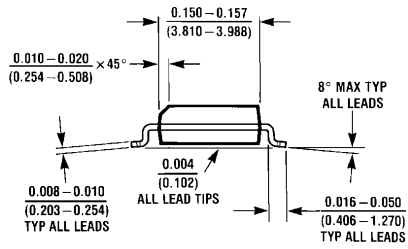
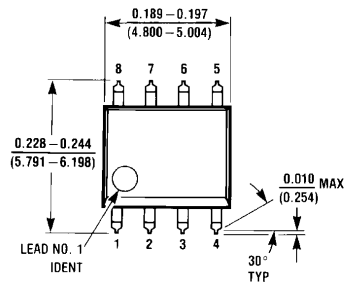

**8-Pin Small Outline Package**  
**Order Number LMC6082AIM or LMC6082IM**  
**NS Package Number M08A**

**Physical Dimensions** inches (millimeters) (Continued)

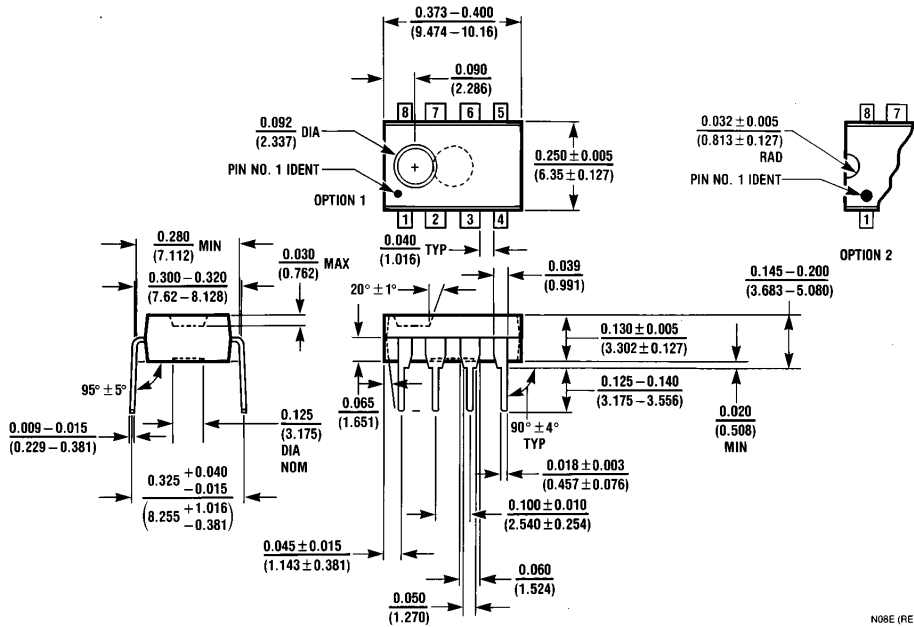

**8-Pin Molded Dual-In-Line Package**  
**Order Number LMC6082AIN, LMC6082AMN or LMC6082IN**  
**NS Package Number N08E**

N08E (REV F)

**LIFE SUPPORT POLICY**

NATIONAL'S PRODUCTS ARE NOT AUTHORIZED FOR USE AS CRITICAL COMPONENTS IN LIFE SUPPORT DEVICES OR SYSTEMS WITHOUT THE EXPRESS WRITTEN APPROVAL OF THE PRESIDENT OF NATIONAL SEMICONDUCTOR CORPORATION. As used herein:

1. Life support devices or systems are devices or systems which, (a) are intended for surgical implant into the body, or (b) support or sustain life, and whose failure to perform, when properly used in accordance with instructions for use provided in the labeling, can be reasonably expected to result in a significant injury to the user.
2. A critical component is any component of a life support device or system whose failure to perform can be reasonably expected to cause the failure of the life support device or system, or to affect its safety or effectiveness.



**National Semiconductor Corporation**  
 2900 Semiconductor Drive  
 P.O. Box 58090  
 Santa Clara, CA 95052-8090  
 Tel: 1(800) 272-9959  
 TWX: (910) 339-9240

**National Semiconductor GmbH**  
 Livny-Gargan-Str. 10  
 D-82256 Fürstenfeldbruck  
 Germany  
 Tel: (81-41) 35-0  
 Telex: 527849  
 Fax: (81-41) 35-1

**National Semiconductor Japan Ltd.**  
 Sumitomo Chemical  
 Engineering Center  
 Bldg. 7F  
 1-7-1, Nakase, Mihama-Ku  
 Chiba-City,  
 Ciba Prefecture 261  
 Tel: (043) 299-2300  
 Fax: (043) 299-2500

**National Semiconductor Hong Kong Ltd.**  
 13th Floor, Straight Block,  
 Ocean Centre, 5 Canton Rd.  
 Tsimshatsui, Kowloon  
 Hong Kong  
 Tel: (852) 2737-1600  
 Fax: (852) 2736-9960

**National Semicondutores Do Brazil Ltda.**  
 Rue Deputado Lacorda Franco  
 120-3A  
 Sao Paulo-SP  
 Brazil 05418-000  
 Tel: (55-11) 212-5066  
 Telex: 391-1131931 NSBR BR  
 Fax: (55-11) 212-1181

**National Semiconductor (Australia) Pty. Ltd.**  
 Building 16  
 Business Park Drive  
 Monash Business Park  
 Nottinghill, Melbourne  
 Victoria 3168 Australia  
 Tel: (3) 558-9999  
 Fax: (3) 558-9998

National does not assume any responsibility for use of any circuitry described, no circuit patent licenses are implied and National reserves the right at any time without notice to change said circuitry and specifications.