

LM6152/LM6154 Dual and Quad 75 MHz GBW Rail-to-Rail I/O Operational Amplifiers

1 Features

- At $V_S = 5V$, typical unless noted.
- Greater than Rail-to-rail Input CMVR $-0.25V$ to $5.25V$
- Rail-to-rail Output Swing $0.01V$ to $4.99V$
- Wide Gain-bandwidth 75 MHz @ 100 kHz
- Slew Rate
 - Small Signal $5\text{ V}/\mu\text{s}$
 - Large Signal $45\text{ V}/\mu\text{s}$
- Low Supply Current $1.4\text{ mA}/\text{amplifier}$
- Wide Supply Range 2.7 V to 24 V
- Fast Settling Time of $1.1\text{ }\mu\text{s}$ for 2 V Step (to 0.01%)
- PSRR 91 dB
- CMRR 84 dB

2 Applications

- Portable High Speed Instrumentation
- Signal Conditioning Amplifier/ADC Buffers
- Barcode Scanners

3 Description

Using patented circuit topologies, the LM6152/LM6154 provides new levels of speed vs. power performance in applications where low voltage supplies or power limitations previously made compromise necessary. With only $1.4\text{ mA}/\text{amplifier}$ supply current, the 75 MHz gain bandwidth of this device supports new portable applications where higher power devices unacceptably drain battery life. The slew rate of the devices increases with increasing input differential voltage, thus allowing the device to handle capacitive loads while maintaining large signal amplitude.

The LM6152/LM6154 can be driven by voltages that exceed both power supply rails, thus eliminating concerns about exceeding the common-mode voltage range. The rail-to-rail output swing capability provides the maximum possible dynamic range at the output. This is particularly important when operating on low supply voltages.

Operating on supplies from 2.7 V to over 24 V , the LM6152/LM6154 is excellent for a very wide range of applications, from battery operated systems with large bandwidth requirements to high speed instrumentation.

Device Information⁽¹⁾

| PART NUMBER | PACKAGE | BODY SIZE (NOM) |
|-------------|-----------|---------------------|
| LM6152 | SOIC (8) | 4.902 mm × 3.912 mm |
| LM6154 | SOIC (14) | 8.636 mm × 3.912 mm |

(1) For all available packages, see the orderable addendum at the end of the datasheet.

Supply Current vs. Supply Voltage

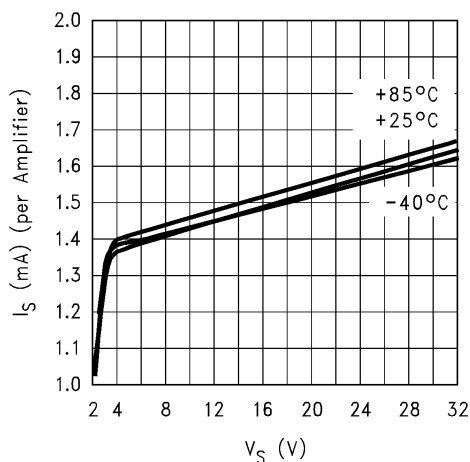

Offset Voltage vs. Supply voltage

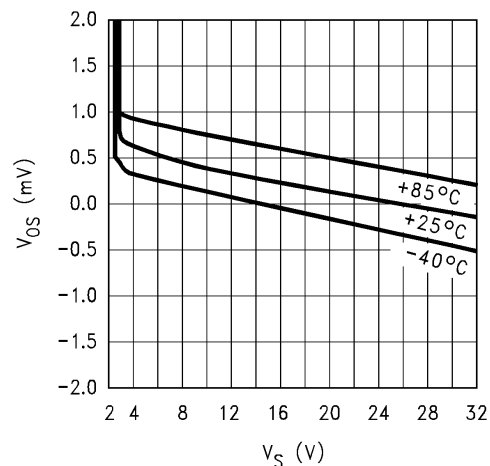

Table of Contents

| | | | |
|---|----------|---|-----------|
| 1 Features | 1 | 6.7 2.7 V DC Electrical Characteristics | 7 |
| 2 Applications | 1 | 6.8 2.7 V AC Electrical Characteristics | 7 |
| 3 Description | 1 | 6.9 24 V DC Electrical Characteristics | 8 |
| 4 Revision History | 2 | 6.10 24 V AC Electrical Characteristics | 8 |
| 5 Pin Configuration and Functions | 3 | 6.11 Typical Performance Characteristics | 9 |
| 6 Specifications | 4 | 7 Application and Implementation | 14 |
| 6.1 Absolute Maximum Ratings | 4 | 8 Device and Documentation Support | 16 |
| 6.2 Handling Ratings | 4 | 8.1 Related Links | 16 |
| 6.3 Recommended Operating Conditions ⁽¹⁾ | 4 | 8.2 Trademarks | 16 |
| 6.4 Thermal Information | 4 | 8.3 Electrostatic Discharge Caution | 16 |
| 6.5 5.0 V DC Electrical Characteristics | 5 | 8.4 Glossary | 16 |
| 6.6 5.0 V AC Electrical Characteristics | 6 | 9 Mechanical, Packaging, and Orderable Information | 16 |

4 Revision History

| Changes from Revision D (March 2013) to Revision E | Page |
|---|-------------|
| • Changed "Junction Temperature Range" to "Operating Temperature Range" and deleted "T _J " in Recommended Operating Conditions | 4 |
| • Deleted T _J = 25°C for Electrical Characteristics Tables | 5 |

| Changes from Revision C (March 2013) to Revision D | Page |
|--|-------------|
| • Changed layout of National Data Sheet to TI format | 15 |

5 Pin Configuration and Functions

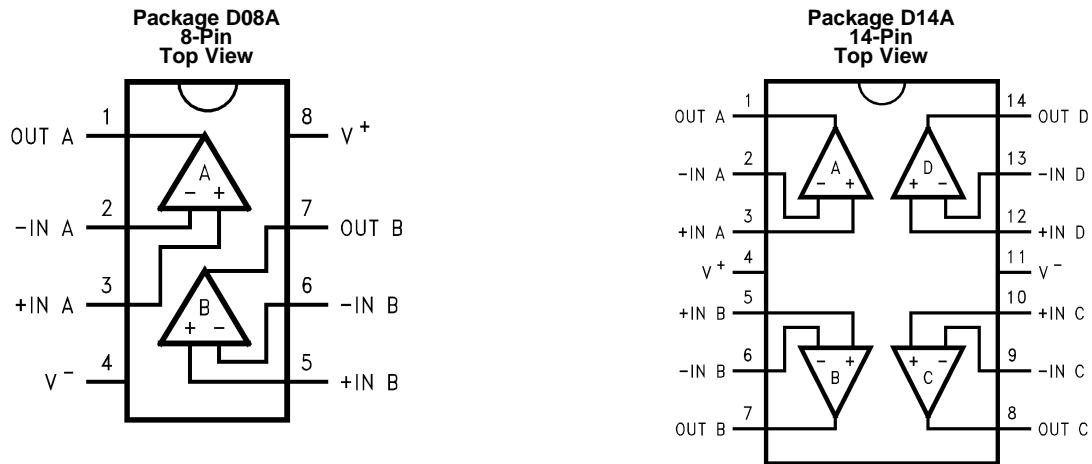

Pin Functions

| NAME | PIN | | I/O | DESCRIPTION |
|----------------|----------------|----------------|-----|-------------------------|
| | LM6152 D08A | LM6154 D14A | | |
| -IN A | 2 | 2 | I | ChA Inverting Input |
| +IN A | 3 | 3 | I | ChA Non-inverting Input |
| -IN B | 6 | 6 | I | ChB Inverting Input |
| +IN B | 5 | 5 | I | ChB Non-inverting Input |
| -IN C | | 9 | I | ChC Inverting Input |
| +IN C | | 10 | I | ChC Non-inverting Input |
| -IN D | | 13 | I | ChD Inverting Input |
| +IN D | | 12 | I | ChD Non-inverting Input |
| OUT A | 1 | 1 | O | ChA Output |
| OUT B | 7 | 7 | O | ChB Output |
| OUT C | | 8 | O | ChC Output |
| OUT D | | 14 | O | ChD Output |
| V ⁻ | 4 | 11 | I | Negative Supply |
| V ⁺ | 8 | 4 | I | Positive Supply |

6 Specifications

6.1 Absolute Maximum Ratings⁽¹⁾⁽²⁾

| | MIN | MAX | UNIT |
|---|-----|--|------|
| Differential Input Voltage | | ±15 | V |
| Voltage at Input/Output Pin | | (V ⁺) + 0.3 (V ⁻) - 0.3 | V |
| Supply Voltage (V ⁺ - V ⁻) | | 35 | V |
| Current at Input Pin | | ±10 | mA |
| Current at Output Pin ⁽³⁾ | | ±25 | mA |
| Current at Power Supply Pin | | 50 | mA |
| Lead Temperature (soldering, 10 sec) | | 260 | °C |
| Junction Temperature ⁽⁴⁾ | | 150 | °C |

- (1) Absolute Maximum Ratings indicate limits beyond which damage to the device may occur. Operating Ratings indicate conditions for which the device is intended to be functional, but specific performance is not ensured. For ensured specifications and the test conditions, see the Electrical Characteristics.
- (2) If Military/Aerospace specified devices are required, please contact the Texas Instruments Sales Office/ Distributors for availability and specifications.
- (3) Applies to both single-supply and split-supply operation. Continuous short circuit operation at elevated ambient temperature can result in exceeding the maximum allowed junction temperature of 150°C.
- (4) The maximum power dissipation is a function of T_{J(MAX)}, R_{θJA}, and T_A. The maximum allowable power dissipation at any ambient temperature is P_D = (T_{J(MAX)} - T_A) / R_{θJA}. All numbers apply for packages soldered directly into a PC board.

6.2 Handling Ratings

| | MIN | MAX | UNIT |
|--|-----|------|------|
| T _{stg} Storage temperature range | -65 | +150 | °C |
| V _(ESD) Electrostatic discharge Human body model (HBM), per ANSI/ESDA/JEDEC JS-001, all pins ⁽¹⁾ | | 2500 | V |

- (1) JEDEC document JEP155 states that 2500-V HBM allows safe manufacturing with a standard ESD control process. Human body model is 1.5 kΩ in series with 100 pF

6.3 Recommended Operating Conditions⁽¹⁾

over operating free-air temperature range (unless otherwise noted)

| | MIN | MAX | UNIT |
|---|-----|---------------------------|------|
| Supply Voltage | | 2.7 ≤ V ⁺ ≤ 24 | V |
| Operating Temperature Range, LM6152, LM6154 | 0 | +70 | °C |

- (1) Absolute Maximum Ratings indicate limits beyond which damage to the device may occur. Operating Ratings indicate conditions for which the device is intended to be functional, but specific performance is not ensured. For ensured specifications and the test conditions, see the Electrical Characteristics.

6.4 Thermal Information

| THERMAL METRIC ⁽¹⁾ | D08A | D14A | UNIT |
|---|---------|---------|------|
| | 8 PINS | 14 PINS | |
| R _{θJA} Junction-to-ambient thermal resistance | 193°C/W | 126°C/W | °C/W |

- (1) For more information about traditional and new thermal metrics, see the *IC Package Thermal Metrics* application report, [SPRA953](#).

6.5 5.0 V DC Electrical Characteristics

Unless otherwise specified, all limits are ensured for $V^+ = 5.0V$, $V^- = 0V$, $V_{CM} = V_O = V^+/2$ and $R_L > 1\text{ M}\Omega$ to $V^+/2$. **Boldface** limits apply at the temperature extremes.

| PARAMETER | TEST CONDITIONS | TYP ⁽¹⁾ | LM6152AC LIMIT ⁽²⁾ | LM6154BC LM6152BC LIMIT ⁽²⁾ | UNIT | |
|------------|------------------------------------|----------------------------|----------------------------------|--|------------------------------|-----------|
| V_{OS} | Input Offset Voltage | 0.54 | 2 4 | 5 7 | mV max | |
| TCV_{OS} | Input Offset Voltage Average Drift | 10 | | | $\mu\text{V}/^\circ\text{C}$ | |
| I_B | Input Bias Current | 500 750 | 980 1500 | 980 1500 | nA max | |
| I_{OS} | Input Offset Current | 32 40 | 100 160 | 100 160 | nA max | |
| R_{IN} | Input Resistance, CM | 30 | | | M Ω | |
| $CMRR$ | Common Mode Rejection Ratio | $0V \leq V_{CM} \leq 4V$ | 94 | 70 | 70 | |
| | | $0V \leq V_{CM} \leq 5V$ | 84 | 60 | 60 | |
| $PSRR$ | Power Supply Rejection Ratio | 91 | 80 | 80 | dB min | |
| V_{CM} | Input Common-Mode Voltage Range | Low | -0.25 | 0 | 0 | |
| | | High | 5.25 | 5.0 | 5.0 | |
| A_V | Large Signal Voltage Gain | 214 | 50 | 50 | V/mV min | |
| V_O | Output Swing | $R_L = 100\text{ k}\Omega$ | 0.006 | 0.02 0.03 | 0.02 0.03 | |
| | | | 4.992 | 4.97 4.96 | 4.97 4.96 | |
| | | $R_L = 2\text{ k}\Omega$ | 0.04 | 0.10 0.12 | 0.10 0.12 | |
| | | | 4.89 | 4.80 4.70 | 4.80 4.70 | |
| I_{SC} | Output Short Circuit Current | Sourcing | 3 | 3 | 3 | |
| | | | 6.2 | 2.5 | 2.5 | |
| | | Sinking | 27 | 27 | 27 | |
| | | | 16.9 | 17 | 17 | |
| I_S | Supply Current | Per Amplifier | 7 | 7 | 7 | |
| | | | 40 | 5 | 5 | |
| | | | 1.4 | 2 2.25 | 2 2.25 | mA max |

(1) Typical Values represent the most likely parametric norm.

(2) All limits are specified by testing or statistical analysis.

6.6 5.0 V AC Electrical Characteristics

Unless otherwise specified, all limits ensured for $V^+ = 5.0V$, $V^- = 0V$, $V_{CM} = V_O = V^+/2$ and $R_L > 1\text{ M}\Omega$ to $V^+/2$. **Boldface** limits apply at the temperature extremes.

| PARAMETER | | TEST CONDITIONS | TYP ⁽¹⁾ | LM6152AC LIMIT ⁽²⁾ | LM6154BC LM6152BC LIMIT ⁽²⁾ | UNIT |
|-----------|------------------------------|--|--------------------|----------------------------------|--|------------------------|
| SR | Slew Rate | $\pm 4V$ Step @ $V_S = \pm 6V$, $R_S < 1\text{ k}\Omega$ | 30 | 24 15 | 24 15 | V/ μ s min |
| GBW | Gain-Bandwidth Product | $f = 100\text{ kHz}$ | 75 | | | MHz |
| | Amp-to-Amp Isolation | $R_L = 10\text{ k}\Omega$ | 125 | | | dB |
| e_n | Input-Referred Voltage Noise | $f = 1\text{ kHz}$ | 9 | | | nV/ $\sqrt{\text{Hz}}$ |
| i_n | Input-Referred Current Noise | $f = 1\text{ kHz}$ | 0.34 | | | pA/ $\sqrt{\text{Hz}}$ |
| T.H.D | Total Harmonic Distortion | $f = 100\text{ kHz}$, $R_L = 10\text{ k}\Omega$ $A_V = -1$, $V_O = 2.5\text{ V}_{PP}$ | -65 | | | dBc |
| ts | Settling Time | 2V Step to 0.01% | 1.1 | | | μ s |

(1) Typical Values represent the most likely parametric norm.

(2) All limits are specified by testing or statistical analysis.

6.7 2.7 V DC Electrical Characteristics

Unless otherwise specified, all limits are ensured for $V^+ = 2.7V$, $V^- = 0V$, $V_{CM} = V_O = V^+/2$ and $R_L > 1\text{ M}\Omega$ to $V^+/2$. **Boldface** limits apply at the temperature extremes.

| PARAMETER | TEST CONDITIONS | TYP ⁽¹⁾ | LM6152AC LIMIT ⁽²⁾ | LM6154BC LM6152BC LIMIT ⁽²⁾ | UNIT | |
|------------|------------------------------------|----------------------------|----------------------------------|--|------------------------------|----------|
| V_{OS} | Input Offset Voltage | 0.8 | 2 5 | 5 8 | mV max | |
| TCV_{OS} | Input Offset Voltage Average Drift | 10 | | | $\mu\text{V}/^\circ\text{C}$ | |
| I_B | Input Bias Current | 500 | | | nA | |
| I_{OS} | Input Offset Current | 50 | | | nA | |
| R_{IN} | Input Resistance, CM | $0V \leq V_{CM} \leq 1.8V$ | 30 | | M Ω | |
| $CMRR$ | Common Mode Rejection Ratio | $0V \leq V_{CM} \leq 1.8V$ | 88 | | dB | |
| | | $0V \leq V_{CM} \leq 2.7V$ | 78 | | | |
| $PSRR$ | Power Supply Rejection Ratio | $3V \leq V^+ \leq 5V$ | 69 | | dB | |
| V_{CM} | Input Common-Mode Voltage Range | Low | -0.25 | 0 | 0 | V |
| | | High | 2.95 | 2.7 | 2.7 | V |
| A_V | Large Signal Voltage Gain | $R_L = 10\text{ k}\Omega$ | 5.5 | | V/mV | |
| V_O | Output Swing | $R_L = 10\text{ k}\Omega$ | 0.032 | 0.07 0.11 | 0.07 0.11 | V max |
| | | | 2.68 | 2.64 2.62 | 2.64 2.62 | V min |
| I_S | Supply Current | Per Amplifier | 1.35 | | mA | |

(1) Typical Values represent the most likely parametric norm.

(2) All limits are specified by testing or statistical analysis.

6.8 2.7 V AC Electrical Characteristics

Unless otherwise specified, all limits are ensured for $V^+ = 2.7V$, $V^- = 0V$, $V_{CM} = V_O = V^+/2$ and $R_L > 1\text{ M}\Omega$ to $V^+/2$. **Boldface** limits apply at the temperature extremes.

| PARAMETER | TEST CONDITIONS | TYP ⁽¹⁾ | LM6152AC LIMIT ⁽²⁾ | LM6154BC LM6152BC LIMIT ⁽²⁾ | UNIT |
|-----------|------------------------|----------------------|----------------------------------|--|------|
| GBW | Gain-Bandwidth Product | $f = 100\text{ kHz}$ | 80 | | MHz |

(1) Typical Values represent the most likely parametric norm.

(2) All limits are specified by testing or statistical analysis.

6.9 24 V DC Electrical Characteristics

Unless otherwise specified, all limits are ensured for $V^+ = 24V$, $V^- = 0V$, $V_{CM} = V_O = V^+/2$ and $R_L > 1\text{ M}\Omega$ to $V^+/2$. **Boldface** limits apply at the temperature extremes.

| PARAMETER | TEST CONDITIONS | TYP ⁽¹⁾ | LM6152AC LIMIT ⁽²⁾ | LM6154BC LM6152BC LIMIT ⁽²⁾ | UNIT |
|---|---------------------------|--------------------|----------------------------------|--|------------------|
| V_{OS} Input Offset Voltage | | 0.3 | 2 4 | 7 9 | mV max |
| TCV_{OS} Input Offset Voltage Average Drift | | 10 | | | $\mu V/^\circ C$ |
| I_B Input Bias Current | | 500 | | | nA |
| I_{OS} Input Offset Current | | 32 | | | nA |
| R_{IN} Input Resistance, CM | $0V \leq V_{CM} \leq 23V$ | 60 | | | Meg Ω |
| $CMRR$ Common Mode Rejection Ratio | $0V \leq V_{CM} \leq 23V$ | 94 | | | dB |
| | $0V \leq V_{CM} \leq 24V$ | 84 | | | |
| $PSRR$ Power Supply Rejection Ratio | $0V \leq V_{CM} \leq 24V$ | 95 | | | dB |
| V_{CM} Input Common-Mode Voltage Range | Low | -0.25 | 0 | 0 | V |
| | High | 24.25 | 24 | 24 | V |
| A_V Large Signal Voltage Gain | $R_L = 10\text{ k}\Omega$ | 55 | | | V/mV |
| V_O Output Swing | $R_L = 10\text{ k}\Omega$ | 0.044 | 0.075 0.090 | 0.075 0.090 | V max |
| | | 23.91 | 23.8 23.7 | 23.8 23.7 | V min |
| I_S Supply Current | Per Amplifier | 1.6 | 2.25 2.50 | 2.25 2.50 | mA max |

(1) Typical Values represent the most likely parametric norm.

(2) All limits are specified by testing or statistical analysis.

6.10 24 V AC Electrical Characteristics

Unless otherwise specified, all limits are ensured for $V^+ = 24V$, $V^- = 0V$, $V_{CM} = V_O = V^+/2$ and $R_L > 1\text{ M}\Omega$ to $V^+/2$. **Boldface** limits apply at the temperature extremes.

| PARAMETER | TEST CONDITIONS | TYP ⁽¹⁾ | LM6152AC LIMIT ⁽²⁾ | LM6154BC LM6152BC LIMIT ⁽²⁾ | UNIT |
|----------------------------|----------------------|--------------------|----------------------------------|--|------|
| GBW Gain-Bandwidth Product | $f = 100\text{ kHz}$ | 80 | | | MHz |

(1) Typical Values represent the most likely parametric norm.

(2) All limits are specified by testing or statistical analysis.

6.11 Typical Performance Characteristics

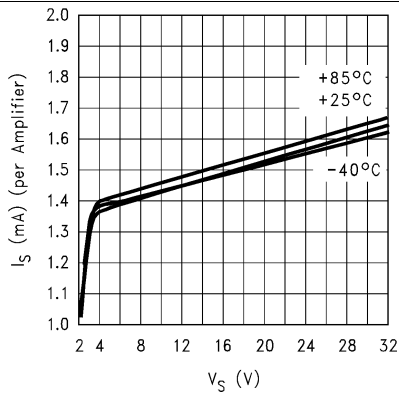

Figure 1. Supply Current vs. Supply Voltage

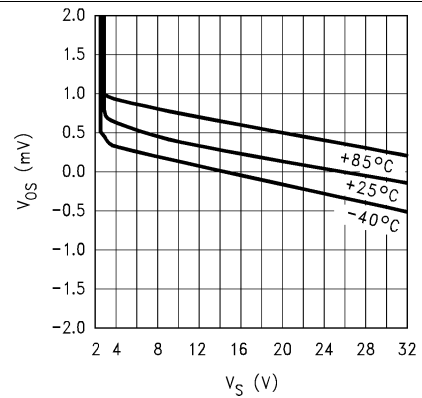

Figure 2. Offset Voltage vs. Supply Voltage

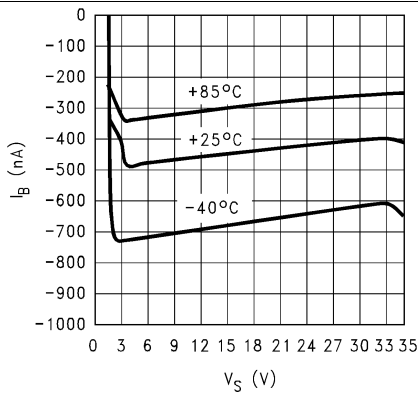

Figure 3. Bias Current vs. Supply Voltage

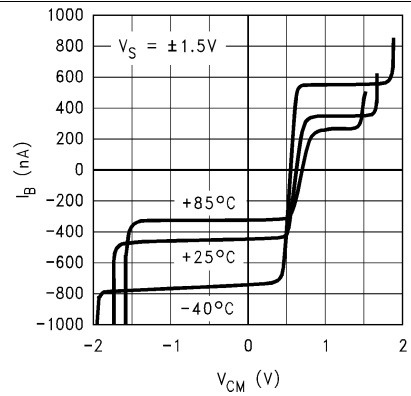

Figure 4. Bias Current vs. V_{CM}

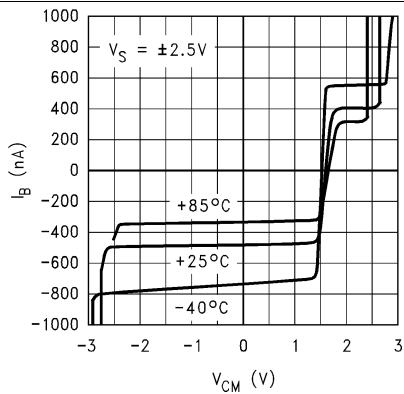

Figure 5. Bias Current vs. V_{CM}

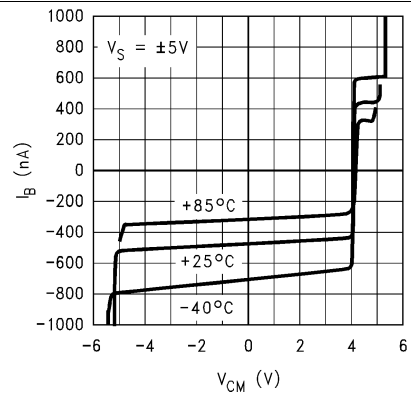
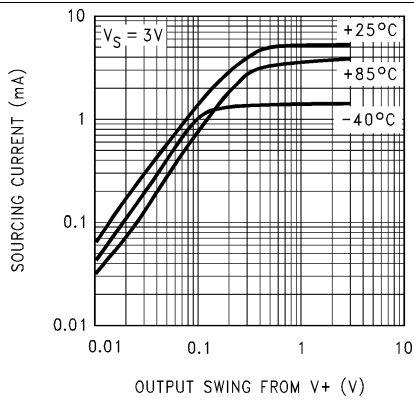
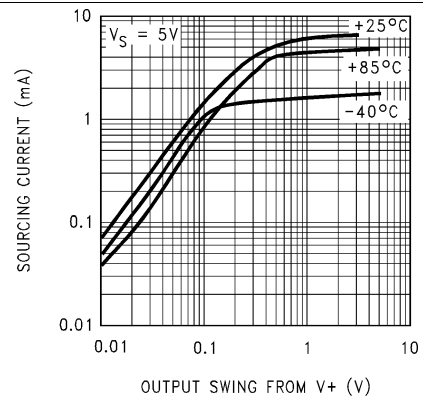
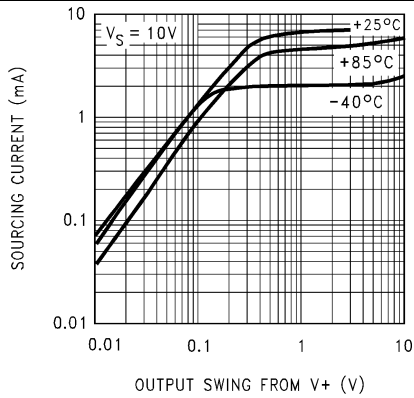
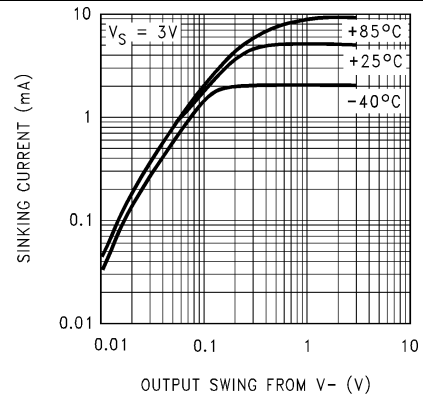
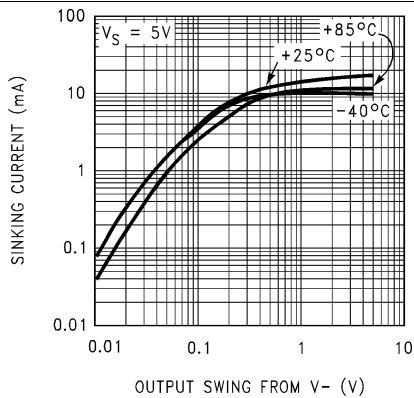
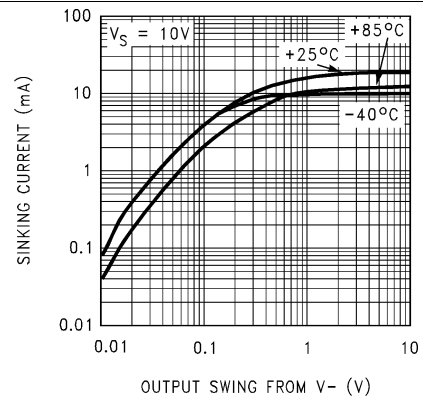

Figure 6. Bias Current vs. V_{CM}

Typical Performance Characteristics (continued)

Figure 7. Output Voltage vs. Source Current

Figure 8. Output Voltage vs. Source Current

Figure 9. Output Voltage vs. Source Current

Figure 10. Output Voltage vs. Sink Current

Figure 11. Output Voltage vs. Sink Current

Figure 12. Output Voltage vs. Sink Current

Typical Performance Characteristics (continued)

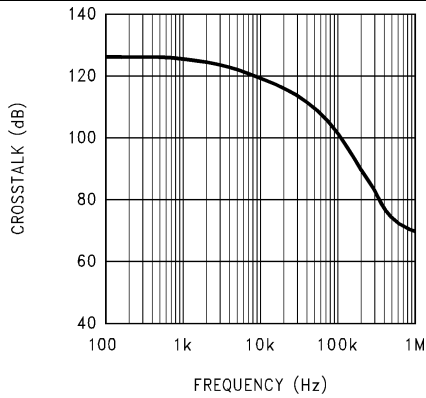

Figure 13. Crosstalk (dB) vs. Frequency

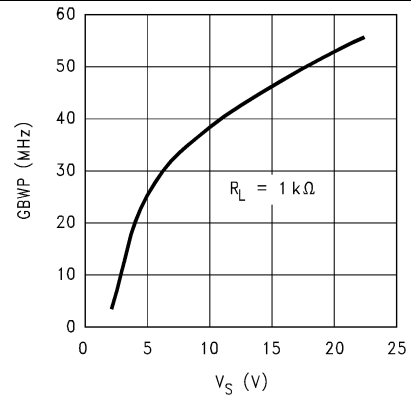

Figure 14. GBWP (@ 100 kHz) vs. Supply Voltage

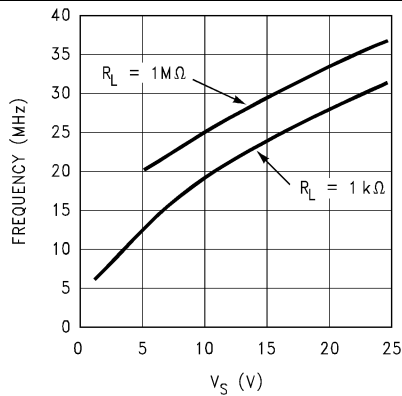

Figure 15. Unity Gain Frequency vs. Supply Voltage for Various Loads

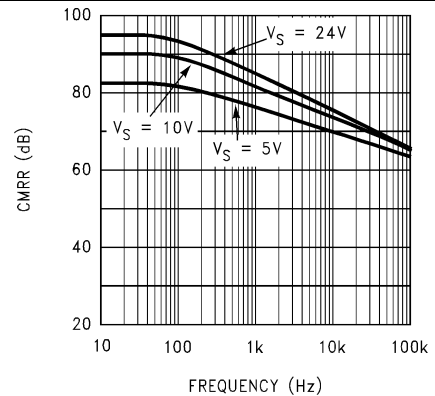

Figure 16. CMRR

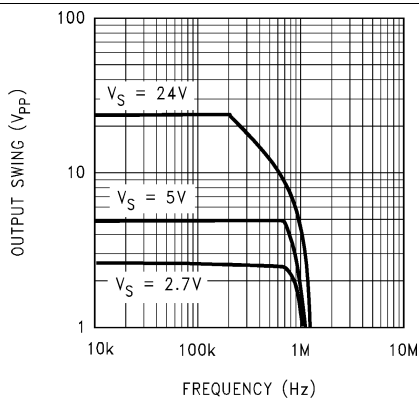

Figure 17. Voltage Swing vs. Frequency (C_L = 100 pF)

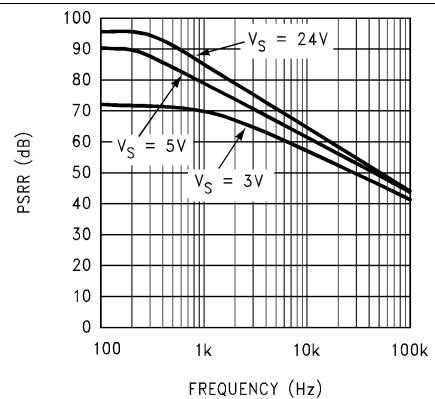

Figure 18. PSRR vs. Frequency

Typical Performance Characteristics (continued)

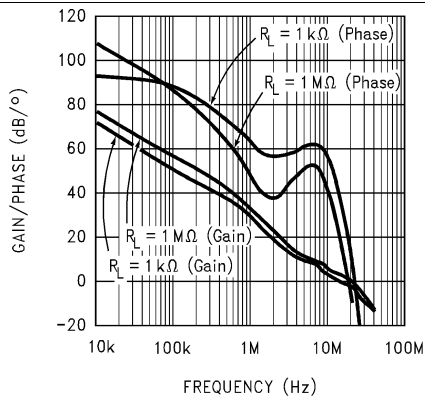

Figure 19. Open Loop Gain/Phase (Vs = 5V)

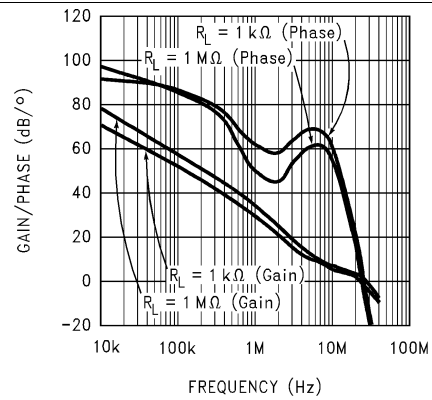

Figure 20. Open Loop Gain/Phase (Vs = 10V)

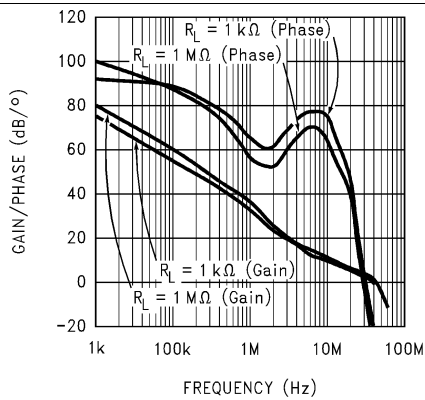

Figure 21. Open Loop Gain/Phase (Vs = 24V)

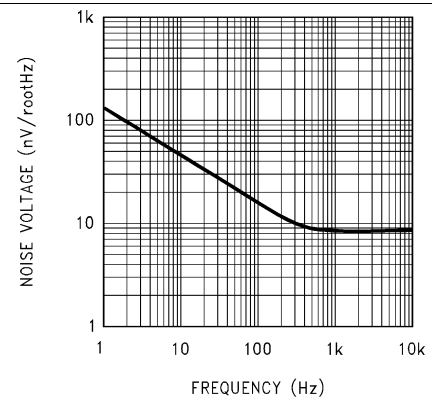

Figure 22. Noise Voltage vs. Frequency

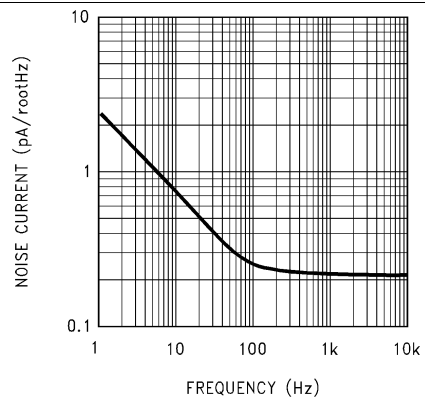

Figure 23. Noise Current vs. Frequency

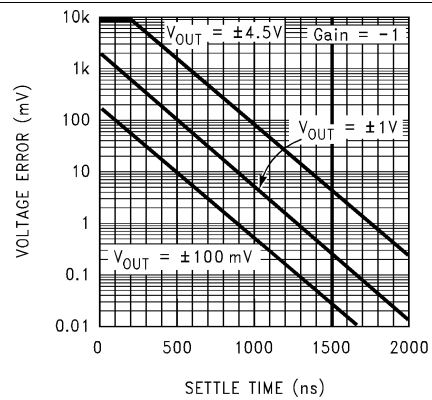

Figure 24. Voltage Error vs. Settle Time

Typical Performance Characteristics (continued)

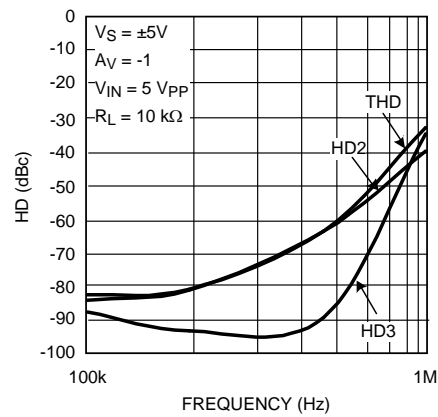

Figure 25. Distortion vs. Frequency

7 Application and Implementation

The LM6152/LM6154 is ideally suited for operation with about 10 kΩ (Feedback Resistor, R_F) between the output and the negative input terminal.

With R_F set to this value, for most applications requiring a close loop gain of 10 or less, an additional small compensation capacitor (C_F) (see Figure 26) is recommended across R_F in order to achieve a reasonable overshoot (10%) at the output by compensating for stray capacitance across the inputs.

The optimum value for C_F can best be established experimentally with a trimmer cap in place since its value is dependant on the supply voltage, output driving load, and the operating gain. Below, some typical values used in an inverting configuration and driving a 10 kΩ load have been tabulated for reference:

Table 1. Typical BW (-3 dB) at Various Supply Voltage and Gains

| V_s Volts | GAIN | C_F pF | BW (-3 dB) MHz |
|----------------|------|-------------|-------------------|
| 3 | -1 | 5.6 | 4 |
| | -10 | 6.8 | 1.97 |
| | -100 | None | 0.797 |
| 24 | -1 | 2.2 | 6.6 |
| | -10 | 4.7 | 2.2 |
| | -100 | None | 0.962 |

In the non-inverting configuration, the LM6152/LM6154 can be used for closed loop gains of +2 and above. In this case, also, the compensation capacitor (C_F) is recommended across R_F (= 10 kΩ) for gains of 10 or less.

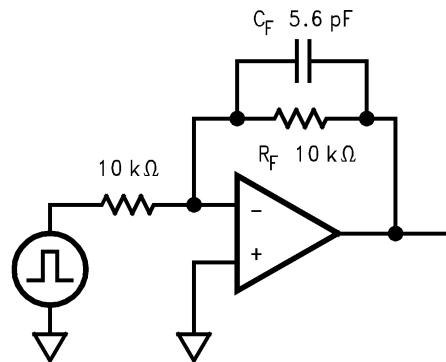

Figure 26. Typical Inverting Gain Circuit $A_V = -1$

Because of the unique structure of this amplifier, when used at low closed loop gains, the realizable BW will be much less than the GBW product would suggest.

The LM6152/LM6154 brings a new level of ease of use to op amp system design.

The greater than rail-to-rail input voltage range eliminates concern over exceeding the common-mode voltage range. The rail-to-rail output swing provides the maximum possible dynamic range at the output. This is particularly important when operating on low supply voltages.

The high gain-bandwidth with low supply current opens new battery powered applications where higher power consumption previously reduced battery life to unacceptable levels.

The ability to drive large capacitive loads without oscillating functional removes this common problem.

To take advantage of these features, some ideas should be kept in mind.

The LM6152/LM6154, capacitive loads do not lead to oscillations, in all but the most extreme conditions, but they will result in reduced bandwidth. They also cause increased settling time.

Unlike most bipolar op amps, the unique phase reversal prevention/speed-up circuit in the input stage, causes the slew rate to be very much a function of the input pulse amplitude. This results in a 10 to 1 increase in slew rate when the differential input signal increases. Large fast pulses will raise the slew-rate to more than 30 V/μs.

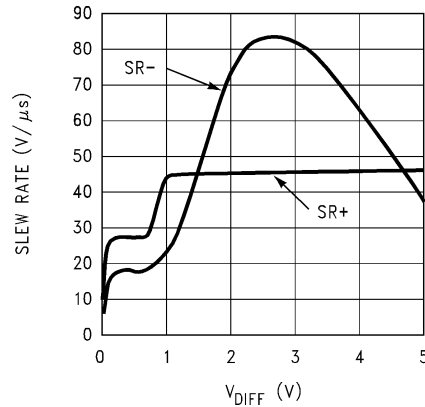

Figure 27. Slew Rate vs. V_{DIFF}

The speed-up action adds stability to the system when driving large capacitive loads.

A conventional op amp exhibits a fixed maximum slew-rate even though the differential input voltage rises due to the lagging output voltage. In the LM6152/LM6154, increasing lag causes the differential input voltage to increase but as it does, the increased slew-rate keeps the output following the input much better. This effectively reduces phase lag. As a result, the LM6152/LM6154 can drive capacitive loads as large as 470 pF at gain of 2 and above, and not oscillate.

Capacitive loads decrease the phase margin of all op amps. This can lead to overshoot, ringing and oscillation. This is caused by the output resistance of the amplifier and the load capacitance forming an R-C phase shift network. The LM6152/6154 senses this phase shift and partly compensates for this effect.

8 Device and Documentation Support

8.1 Related Links

The table below lists quick access links. Categories include technical documents, support and community resources, tools and software, and quick access to sample or buy.

Table 2. Related Links

| PARTS | PRODUCT FOLDER | SAMPLE & BUY | TECHNICAL DOCUMENTS | TOOLS & SOFTWARE | SUPPORT & COMMUNITY |
|--------|----------------------------|----------------------------|----------------------------|----------------------------|----------------------------|
| LM6152 | Click here | Click here | Click here | Click here | Click here |
| LM6154 | Click here | Click here | Click here | Click here | Click here |

8.2 Trademarks

All trademarks are the property of their respective owners.

8.3 Electrostatic Discharge Caution



These devices have limited built-in ESD protection. The leads should be shorted together or the device placed in conductive foam during storage or handling to prevent electrostatic damage to the MOS gates.

8.4 Glossary

[SLYZ022](#) — *TI Glossary*.

This glossary lists and explains terms, acronyms, and definitions.

9 Mechanical, Packaging, and Orderable Information

The following pages include mechanical, packaging, and orderable information. This information is the most current data available for the designated devices. This data is subject to change without notice and revision of this document. For browser-based versions of this data sheet, refer to the left-hand navigation.

PACKAGING INFORMATION

| Orderable Device | Status (1) | Package Type | Package Drawing | Pins | Package Qty | Eco Plan (2) | Lead/Ball Finish (6) | MSL Peak Temp (3) | Op Temp (°C) | Device Marking (4/5) | Samples |
|------------------|---------------|--------------|-----------------|------|-------------|----------------------------|-------------------------|----------------------|--------------|-------------------------|----------------|
| LM6152ACM | NRND | SOIC | D | 8 | 95 | TBD | Call TI | Call TI | 0 to 70 | LM61 52ACM | |
| LM6152ACM/NOPB | ACTIVE | SOIC | D | 8 | 95 | Green (RoHS & no Sb/Br) | CU SN | Level-1-260C-UNLIM | 0 to 70 | LM61 52ACM | Samples |
| LM6152ACMX | NRND | SOIC | D | 8 | 2500 | TBD | Call TI | Call TI | 0 to 70 | LM61 52ACM | |
| LM6152ACMX/NOPB | ACTIVE | SOIC | D | 8 | 2500 | Green (RoHS & no Sb/Br) | CU SN | Level-1-260C-UNLIM | 0 to 70 | LM61 52ACM | Samples |
| LM6152BCM/NOPB | ACTIVE | SOIC | D | 8 | 95 | Green (RoHS & no Sb/Br) | CU SN | Level-1-260C-UNLIM | 0 to 70 | LM61 52BCM | Samples |
| LM6152BCM | NRND | SOIC | D | 8 | 2500 | TBD | Call TI | Call TI | 0 to 70 | LM61 52BCM | |
| LM6152BCM/NOPB | ACTIVE | SOIC | D | 8 | 2500 | Green (RoHS & no Sb/Br) | CU SN | Level-1-260C-UNLIM | 0 to 70 | LM61 52BCM | Samples |
| LM6154BCM | NRND | SOIC | D | 14 | 55 | TBD | Call TI | Call TI | 0 to 70 | LM6154BCM | |
| LM6154BCM/NOPB | ACTIVE | SOIC | D | 14 | 55 | Green (RoHS & no Sb/Br) | CU SN | Level-1-260C-UNLIM | 0 to 70 | LM6154BCM | Samples |
| LM6154BCM/NOPB | ACTIVE | SOIC | D | 14 | 2500 | Green (RoHS & no Sb/Br) | CU SN | Level-1-260C-UNLIM | 0 to 70 | LM6154BCM | Samples |

(1) The marketing status values are defined as follows:

ACTIVE: Product device recommended for new designs.

LIFEBUY: TI has announced that the device will be discontinued, and a lifetime-buy period is in effect.

NRND: Not recommended for new designs. Device is in production to support existing customers, but TI does not recommend using this part in a new design.

PREVIEW: Device has been announced but is not in production. Samples may or may not be available.

OBSELETE: TI has discontinued the production of the device.

(2) Eco Plan - The planned eco-friendly classification: Pb-Free (RoHS), Pb-Free (RoHS Exempt), or Green (RoHS & no Sb/Br) - please check <http://www.ti.com/productcontent> for the latest availability information and additional product content details.

TBD: The Pb-Free/Green conversion plan has not been defined.

Pb-Free (RoHS): TI's terms "Lead-Free" or "Pb-Free" mean semiconductor products that are compatible with the current RoHS requirements for all 6 substances, including the requirement that lead not exceed 0.1% by weight in homogeneous materials. Where designed to be soldered at high temperatures, TI Pb-Free products are suitable for use in specified lead-free processes.

Pb-Free (RoHS Exempt): This component has a RoHS exemption for either 1) lead-based flip-chip solder bumps used between the die and package, or 2) lead-based die adhesive used between the die and leadframe. The component is otherwise considered Pb-Free (RoHS compatible) as defined above.

Green (RoHS & no Sb/Br): TI defines "Green" to mean Pb-Free (RoHS compatible), and free of Bromine (Br) and Antimony (Sb) based flame retardants (Br or Sb do not exceed 0.1% by weight in homogeneous material)

- (3) MSL, Peak Temp. - The Moisture Sensitivity Level rating according to the JEDEC industry standard classifications, and peak solder temperature.
- (4) There may be additional marking, which relates to the logo, the lot trace code information, or the environmental category on the device.
- (5) Multiple Device Markings will be inside parentheses. Only one Device Marking contained in parentheses and separated by a "~" will appear on a device. If a line is indented then it is a continuation of the previous line and the two combined represent the entire Device Marking for that device.
- (6) Lead/Ball Finish - Orderable Devices may have multiple material finish options. Finish options are separated by a vertical ruled line. Lead/Ball Finish values may wrap to two lines if the finish value exceeds the maximum column width.

Important Information and Disclaimer:The information provided on this page represents TI's knowledge and belief as of the date that it is provided. TI bases its knowledge and belief on information provided by third parties, and makes no representation or warranty as to the accuracy of such information. Efforts are underway to better integrate information from third parties. TI has taken and continues to take reasonable steps to provide representative and accurate information but may not have conducted destructive testing or chemical analysis on incoming materials and chemicals. TI and TI suppliers consider certain information to be proprietary, and thus CAS numbers and other limited information may not be available for release.

In no event shall TI's liability arising out of such information exceed the total purchase price of the TI part(s) at issue in this document sold by TI to Customer on an annual basis.

TAPE AND REEL INFORMATION



QUADRANT ASSIGNMENTS FOR PIN 1 ORIENTATION IN TAPE



*All dimensions are nominal

| Device | Package Type | Package Drawing | Pins | SPQ | Reel Diameter (mm) | Reel Width W1 (mm) | A0 (mm) | B0 (mm) | K0 (mm) | P1 (mm) | W (mm) | Pin1 Quadrant |
|-----------------|--------------|-----------------|------|------|--------------------|--------------------|---------|---------|---------|---------|--------|---------------|
| LM6152ACMX | SOIC | D | 8 | 2500 | 330.0 | 12.4 | 6.5 | 5.4 | 2.0 | 8.0 | 12.0 | Q1 |
| LM6152ACMX/NOPB | SOIC | D | 8 | 2500 | 330.0 | 12.4 | 6.5 | 5.4 | 2.0 | 8.0 | 12.0 | Q1 |
| LM6152BCMX | SOIC | D | 8 | 2500 | 330.0 | 12.4 | 6.5 | 5.4 | 2.0 | 8.0 | 12.0 | Q1 |
| LM6152BCMX/NOPB | SOIC | D | 8 | 2500 | 330.0 | 12.4 | 6.5 | 5.4 | 2.0 | 8.0 | 12.0 | Q1 |
| LM6154BCMX/NOPB | SOIC | D | 14 | 2500 | 330.0 | 16.4 | 6.5 | 9.35 | 2.3 | 8.0 | 16.0 | Q1 |

TAPE AND REEL BOX DIMENSIONS

*All dimensions are nominal

| Device | Package Type | Package Drawing | Pins | SPQ | Length (mm) | Width (mm) | Height (mm) |
|-----------------|--------------|-----------------|------|------|-------------|------------|-------------|
| LM6152ACMX | SOIC | D | 8 | 2500 | 367.0 | 367.0 | 35.0 |
| LM6152ACMX/NOPB | SOIC | D | 8 | 2500 | 367.0 | 367.0 | 35.0 |
| LM6152BCMX | SOIC | D | 8 | 2500 | 367.0 | 367.0 | 35.0 |
| LM6152BCMX/NOPB | SOIC | D | 8 | 2500 | 367.0 | 367.0 | 35.0 |
| LM6154BCMX/NOPB | SOIC | D | 14 | 2500 | 367.0 | 367.0 | 35.0 |

D (R-PDSO-G14)

PLASTIC SMALL OUTLINE



- NOTES:
- A. All linear dimensions are in inches (millimeters).
 - B. This drawing is subject to change without notice.
 -  Body length does not include mold flash, protrusions, or gate burrs. Mold flash, protrusions, or gate burrs shall not exceed 0.006 (0,15) each side.
 -  Body width does not include interlead flash. Interlead flash shall not exceed 0.017 (0,43) each side.
 - E. Reference JEDEC MS-012 variation AB.

IMPORTANT NOTICE

Texas Instruments Incorporated and its subsidiaries (TI) reserve the right to make corrections, enhancements, improvements and other changes to its semiconductor products and services per JESD46, latest issue, and to discontinue any product or service per JESD48, latest issue. Buyers should obtain the latest relevant information before placing orders and should verify that such information is current and complete. All semiconductor products (also referred to herein as "components") are sold subject to TI's terms and conditions of sale supplied at the time of order acknowledgment.

TI warrants performance of its components to the specifications applicable at the time of sale, in accordance with the warranty in TI's terms and conditions of sale of semiconductor products. Testing and other quality control techniques are used to the extent TI deems necessary to support this warranty. Except where mandated by applicable law, testing of all parameters of each component is not necessarily performed.

TI assumes no liability for applications assistance or the design of Buyers' products. Buyers are responsible for their products and applications using TI components. To minimize the risks associated with Buyers' products and applications, Buyers should provide adequate design and operating safeguards.

TI does not warrant or represent that any license, either express or implied, is granted under any patent right, copyright, mask work right, or other intellectual property right relating to any combination, machine, or process in which TI components or services are used. Information published by TI regarding third-party products or services does not constitute a license to use such products or services or a warranty or endorsement thereof. Use of such information may require a license from a third party under the patents or other intellectual property of the third party, or a license from TI under the patents or other intellectual property of TI.

Reproduction of significant portions of TI information in TI data books or data sheets is permissible only if reproduction is without alteration and is accompanied by all associated warranties, conditions, limitations, and notices. TI is not responsible or liable for such altered documentation. Information of third parties may be subject to additional restrictions.

Resale of TI components or services with statements different from or beyond the parameters stated by TI for that component or service voids all express and any implied warranties for the associated TI component or service and is an unfair and deceptive business practice. TI is not responsible or liable for any such statements.

Buyer acknowledges and agrees that it is solely responsible for compliance with all legal, regulatory and safety-related requirements concerning its products, and any use of TI components in its applications, notwithstanding any applications-related information or support that may be provided by TI. Buyer represents and agrees that it has all the necessary expertise to create and implement safeguards which anticipate dangerous consequences of failures, monitor failures and their consequences, lessen the likelihood of failures that might cause harm and take appropriate remedial actions. Buyer will fully indemnify TI and its representatives against any damages arising out of the use of any TI components in safety-critical applications.

In some cases, TI components may be promoted specifically to facilitate safety-related applications. With such components, TI's goal is to help enable customers to design and create their own end-product solutions that meet applicable functional safety standards and requirements. Nonetheless, such components are subject to these terms.

No TI components are authorized for use in FDA Class III (or similar life-critical medical equipment) unless authorized officers of the parties have executed a special agreement specifically governing such use.

Only those TI components which TI has specifically designated as military grade or "enhanced plastic" are designed and intended for use in military/aerospace applications or environments. Buyer acknowledges and agrees that any military or aerospace use of TI components which have **not** been so designated is solely at the Buyer's risk, and that Buyer is solely responsible for compliance with all legal and regulatory requirements in connection with such use.

TI has specifically designated certain components as meeting ISO/TS16949 requirements, mainly for automotive use. In any case of use of non-designated products, TI will not be responsible for any failure to meet ISO/TS16949.

Products

| | |
|------------------------------|--|
| Audio | www.ti.com/audio |
| Amplifiers | amplifier.ti.com |
| Data Converters | dataconverter.ti.com |
| DLP® Products | www.dlp.com |
| DSP | dsp.ti.com |
| Clocks and Timers | www.ti.com/clocks |
| Interface | interface.ti.com |
| Logic | logic.ti.com |
| Power Mgmt | power.ti.com |
| Microcontrollers | microcontroller.ti.com |
| RFID | www.ti-rfid.com |
| OMAP Applications Processors | www.ti.com/omap |
| Wireless Connectivity | www.ti.com/wirelessconnectivity |

Applications

| | |
|-------------------------------|--|
| Automotive and Transportation | www.ti.com/automotive |
| Communications and Telecom | www.ti.com/communications |
| Computers and Peripherals | www.ti.com/computers |
| Consumer Electronics | www.ti.com/consumer-apps |
| Energy and Lighting | www.ti.com/energy |
| Industrial | www.ti.com/industrial |
| Medical | www.ti.com/medical |
| Security | www.ti.com/security |
| Space, Avionics and Defense | www.ti.com/space-avionics-defense |
| Video and Imaging | www.ti.com/video |

TI E2E Community

e2e.ti.com

Mouser Electronics

Authorized Distributor

Click to View Pricing, Inventory, Delivery & Lifecycle Information:

[Texas Instruments:](#)

[LM6154BCM](#) [LM6154BCM/NOPB](#) [LM6154BCM/NOPB](#)