

## LM2991 Negative Low Dropout Adjustable Regulator

### General Description

The LM2991 is a low dropout adjustable negative regulator with a output voltage range between  $-3V$  to  $-24V$ . The LM2991 provides up to 1A of load current and features a  $\overline{ON}/OFF$  pin for remote shutdown capability.

The LM2991 uses new circuit design techniques to provide a low dropout voltage, low quiescent current and low temperature coefficient precision reference. The dropout voltage at 1A load current is typically 0.6V and a guaranteed worst-case maximum of 1V over the entire operating temperature range. The quiescent current is typically 1 mA with a 1A load current and an input-output voltage differential greater than 3V. A unique circuit design of the internal bias supply limits the quiescent current to only 9 mA (typical) when the regulator is in the dropout mode ( $V_{OUT} - V_{IN} \leq 3V$ ).

The LM2991 is short-circuit proof, and thermal shutdown includes hysteresis to enhance the reliability of the device when inadvertently overloaded for extended periods. The LM2991 is available in 5-lead TO-220 and TO-263 packages and is rated for operation over the automotive temperature range of  $-40^{\circ}C$  to  $+125^{\circ}C$ . Mil-Aero versions are also available.

### Features

- Output voltage adjustable from  $-3V$  to  $-24V$ , typically  $-2V$  to  $-25V$
- Output current in excess of 1A
- Dropout voltage typically 0.6V at 1A load
- Low quiescent current
- Internal short circuit current limit
- Internal thermal shutdown with hysteresis
- TTL, CMOS compatible  $\overline{ON}/OFF$  switch
- Functional complement to the LM2941 series

### Applications

- Post switcher regulator
- Local, on-card, regulation
- Battery operated equipment

### Typical Application

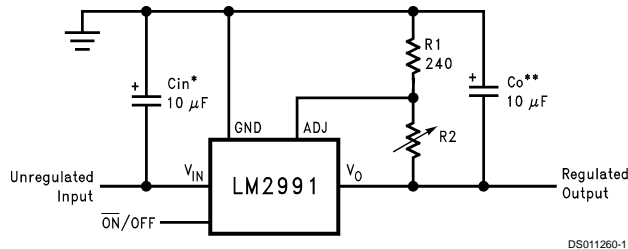

$$V_{OUT} = V_{REF} (1 + R2/R1)$$

\*Required if the regulator is located further than 6 inches from the power supply filter capacitors. A 1  $\mu F$  solid tantalum or a 10  $\mu F$  aluminum electrolytic capacitor is recommended.

\*\*Required for stability. Must be at least a 10  $\mu F$  aluminum electrolytic or a 1  $\mu F$  solid tantalum to maintain stability. May be increased without bound to maintain regulation during transients. Locate the capacitor as close as possible to the regulator. The equivalent series resistance (ESR) is critical, and should be less than 10  $\Omega$  over the same operating temperature range as the regulator.

## Connection Diagrams and Ordering Information

**5-Lead TO-220  
Straight Leads**

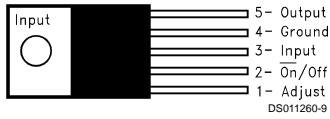

**Front View**  
Order Number **LM2991T**  
See NS Package Number **T05A**

**5-Lead TO-220  
Bent, Staggered Leads**

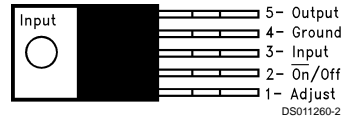

**Front View**  
Order Number **LM2991T Flow LB03**  
See NS Package Number **T05D**

**TO263  
5-Lead Surface-Mount Package**

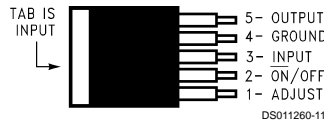

**Top View**



**Side View**  
Order Number **LM2991S**  
See NS Package Number **TS5B**

**16-Lead Ceramic Dual-in-Line Package**

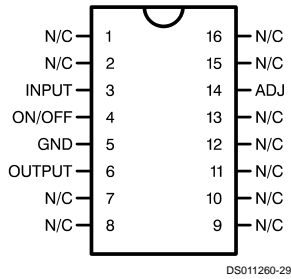

**Top View**  
Order Number **LM2991J-QMLV**  
**5962-9650501VEA**  
Order Number **LM2991J-QML**  
**5962-9650501QEA**  
See NS Package Number **J16A**

**16-Lead Ceramic Surface-Mount Package**

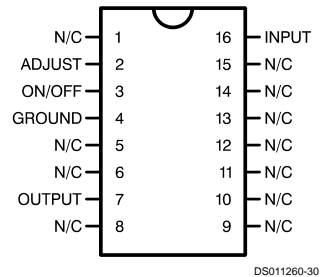

**Top View**  
Order Number **LM2991WG-QML**  
**5962-9650501QXA**  
See NS Package Number **WG16A**

## Absolute Maximum Ratings (Note 1)

If Military/Aerospace specified devices are required, please contact the National Semiconductor Sales Office/Distributors for availability and specifications.

Input Voltage	-26V to +0.3V
ESD Susceptibility (Note 2)	2 kV
Power Dissipation (Note 3)	Internally limited
Junction Temperature ( $T_{Jmax}$ )	125°C

Storage Temperature Range	-65°C to +150°C
Lead Temperature (Soldering, 10 sec.)	230°C

## Operating Ratings (Note 1)

Junction Temperature Range ( $T_J$ )	-40°C to +125°C
Maximum Input Voltage (Operational)	-26V

## Electrical Characteristics

$V_{IN} = -10V$ ,  $V_O = -3V$ ,  $I_O = 1A$ ,  $C_O = 47 \mu F$ ,  $R1 = 2.7k$ ,  $T_J = 25^\circ C$ , unless otherwise specified. **Boldface** limits apply over the entire operating junction temperature range.

Parameter	Conditions	Typical (Note 4)	Min	Max	Units
Reference Voltage	$5 mA \leq I_O \leq 1A$	-1.210	-1.234	-1.186	V
	$5 mA \leq I_O \leq 1A$ , $V_O - 1V \geq V_{IN} \geq -26V$		<b>-1.27</b>	<b>-1.15</b>	V
Output Voltage Range		-2		-3	V
	$V_{IN} = -26V$	-25	-24		V
Line Regulation	$I_O = 5 mA$ , $V_O - 1V \geq V_{IN} \geq -26V$	0.004		0.04	%/V
Load Regulation	$50 mA \leq I_O \leq 1A$	0.04		0.4	%
Dropout Voltage	$I_O = 0.1A$ , $\Delta V_O \leq 100 mV$	0.1		0.2	V
	$I_O = 1A$ , $\Delta V_O \leq 100 mV$	0.6		0.8	V
				<b>1</b>	
Quiescent Current	$I_O \leq 1A$	0.7		5	mA
Dropout Quiescent Current	$V_{IN} = V_O$ , $I_O \leq 1A$	16		50	mA
Ripple Rejection	$V_{ripple} = 1 V_{rms}$ , $f_{ripple} = 1 kHz$ , $I_O = 5 mA$	60	50		dB
Output Noise	10 Hz – 100 kHz, $I_O = 5 mA$	200		450	$\mu V$
$\overline{ON}$ /OFF Input Voltage	( $V_{OUT}$ : ON)	1.2		0.8	V
	( $V_{OUT}$ : OFF)	1.3	2.4		
$\overline{ON}$ /OFF Input Current	$V_{ON/OFF} = 0.8V$ ( $V_{OUT}$ : ON)	0.1		10	$\mu A$
	$V_{ON/OFF} = 2.4V$ ( $V_{OUT}$ : OFF)	40		100	
Output Leakage Current	$V_{IN} = -26V$ , $V_{ON/OFF} = 2.4V$ $V_{OUT} = 0V$	60		250	$\mu A$
Current Limit	$V_{OUT} = 0V$	2	1.5		A

**Note 1:** Absolute Maximum Ratings indicate limits beyond which damage to the device may occur. Operating Ratings indicate conditions for which the device is intended to be functional, but do not guarantee specific performance limits. For guaranteed specifications and test conditions, see the Electrical Characteristics.

**Note 2:** Human body model, 100 pF discharged through a 1.5 k $\Omega$  resistor.

**Note 3:** The maximum power dissipation is a function of  $T_{Jmax}$ ,  $\theta_{JA}$  and  $T_A$ . The maximum allowable power dissipation at any ambient temperature is  $P_D = (T_{Jmax} - T_A)/\theta_{JA}$ . If this dissipation is exceeded, the die temperature will rise above 125°C and the LM2991 will go into thermal shutdown. For the LM2991, the junction-to-ambient thermal resistance is 53°C/W for the TO-220, 73°C/W for the TO-263, and junction-to-case thermal resistance is 3°C. If the TO-263 package is used, the thermal resistance can be reduced by increasing the PC board copper area thermally connected to the package. Using 0.5 square inches of copper area,  $\theta_{JA}$  is 50°C/W; with 1 square inch of copper area,  $\theta_{JA}$  is 37°C/W; and with 1.6 or more square inches of copper area,  $\theta_{JA}$  is 32°C/W.

**Note 4:** Typical values are at  $T_J = 25^\circ C$  and represent the most likely parametric norm.

# Typical Performance Characteristics

**Dropout Voltage**

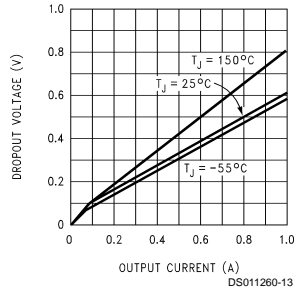

**Normalized Output Voltage**

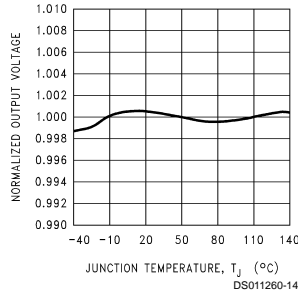

**Output Voltage**

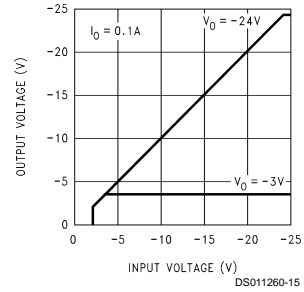

**Output Noise Voltage**

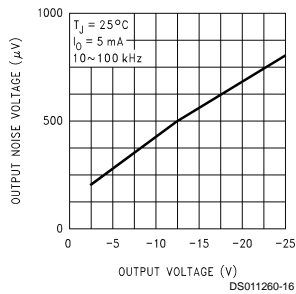

**Quiescent Current**

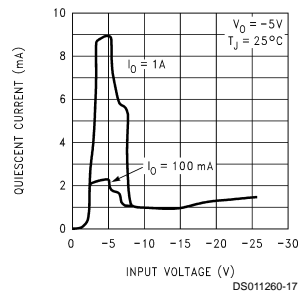

**Maximum Output Current**

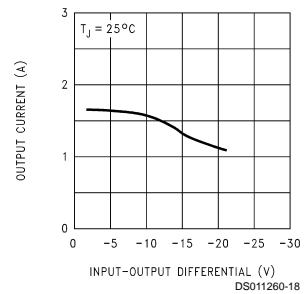

**Line Transient Response**

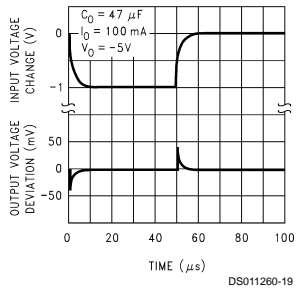

**Load Transient Response**

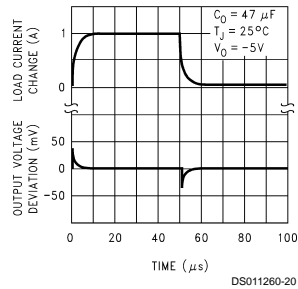

**Maximum Output Current**

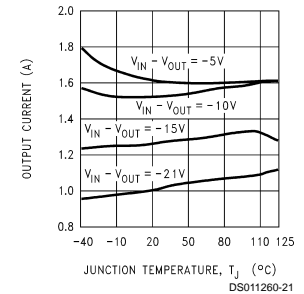

**Ripple Rejection**

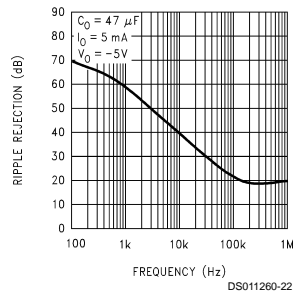

**Output Impedance**

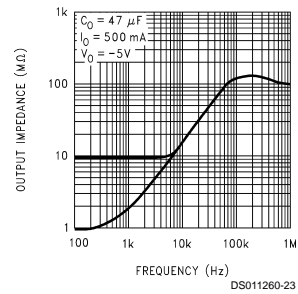

**ON/OFF Control Voltage**

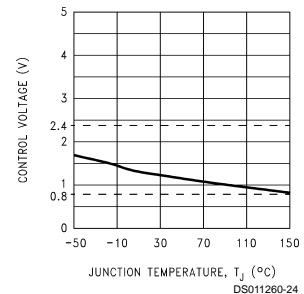

## Typical Performance Characteristics (Continued)

**Adjust Pin Current**

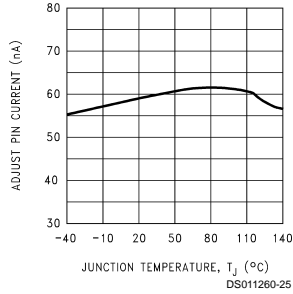

**Low Voltage Behavior**

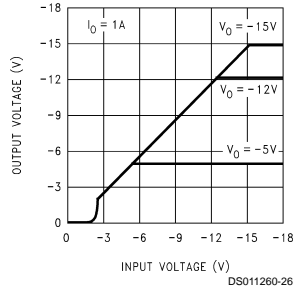

**Maximum Power Dissipation (TO-220)**

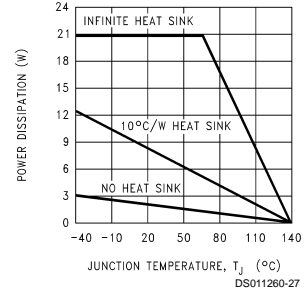

**Maximum Power Dissipation (TO-263) (See Note 3)**

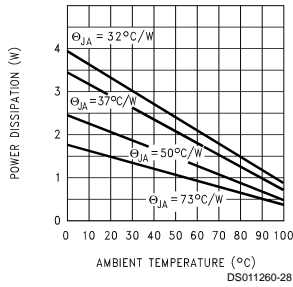

## Application Hints

### EXTERNAL CAPACITORS

The LM2991 regulator requires an output capacitor to maintain stability. The capacitor must be at least 10  $\mu\text{F}$  aluminum electrolytic or 1  $\mu\text{F}$  solid tantalum. The output capacitor's ESR must be less than 10  $\Omega$ , or the zero added to the regulator frequency response by the ESR could reduce the phase margin, creating oscillations. The shaded area in the Output Capacitor ESR graph indicates the recommended ESR range. An input capacitor, of at least 1  $\mu\text{F}$  solid tantalum or 10  $\mu\text{F}$  aluminum electrolytic, is also needed if the regulator is situated more than 6 inches from the input power supply filter.

**Output Capacitor ESR Range**

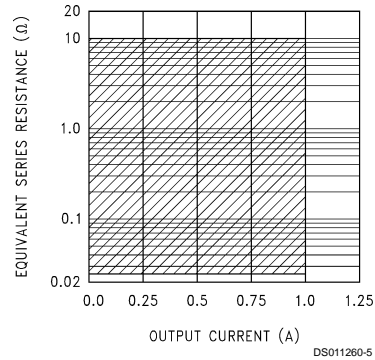

### MINIMUM LOAD

A minimum load current of 500  $\mu\text{A}$  is required for proper operation. The external resistor divider can provide the minimum load, with the resistor from the adjust pin to ground set to 2.4 k $\Omega$ .

### SETTING THE OUTPUT VOLTAGE

The output voltage of the LM2991 is set externally by a resistor divider using the following equation:

$$V_{OUT} = V_{REF} \times (1 + R_2/R_1) - (I_{ADJ} \times R_2)$$

where  $V_{REF} = -1.21V$ . The output voltage can be programmed within the range of -3V to -24V, typically an even

## Application Hints (Continued)

greater range of  $-2V$  to  $-25V$ . The adjust pin current is about  $60\text{ nA}$ , causing a slight error in the output voltage. However, using resistors lower than  $100\text{ k}\Omega$  makes the adjust pin current negligible. For example, neglecting the adjust pin current, and setting  $R_2$  to  $100\text{ k}\Omega$  and  $V_{OUT}$  to  $-5V$ , results in an output voltage error of only  $0.16\%$ .

### ON/OFF PIN

The LM2991 regulator can be turned off by applying a TTL or CMOS level high signal to the ON/OFF pin (see Adjustable Current Sink Application).

## Typical Applications

### FORCING THE OUTPUT POSITIVE

Due to an internal clamp circuit, the LM2991 can withstand positive voltages on its output. If the voltage source pulling the output positive is DC, the current must be limited to  $1.5A$ . A current over  $1.5A$  fed back into the LM2991 could damage the device. The LM2991 output can also withstand fast positive voltage transients up to  $26V$ , without any current limiting of the source. However, if the transients have a duration of over  $1\text{ ms}$ , the output should be clamped with a Schottky diode to ground.

Fully Isolated Post-Switcher Regulator

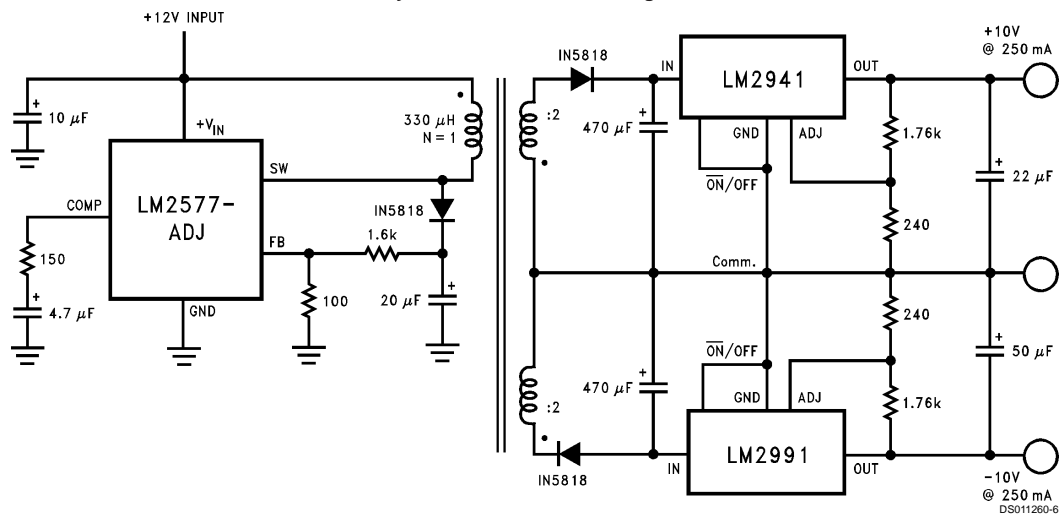

Adjustable Current Sink

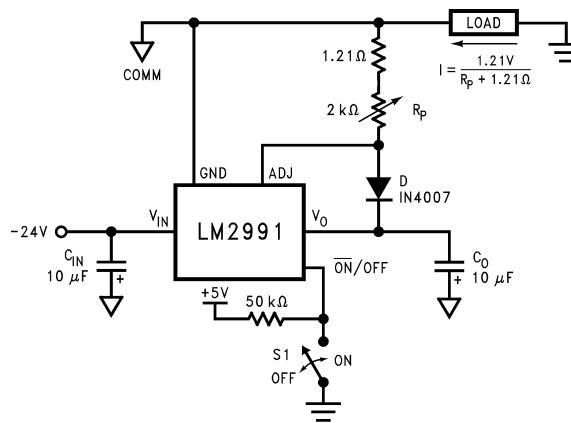

DS011260-10









**Physical Dimensions** inches (millimeters) unless otherwise noted (Continued)

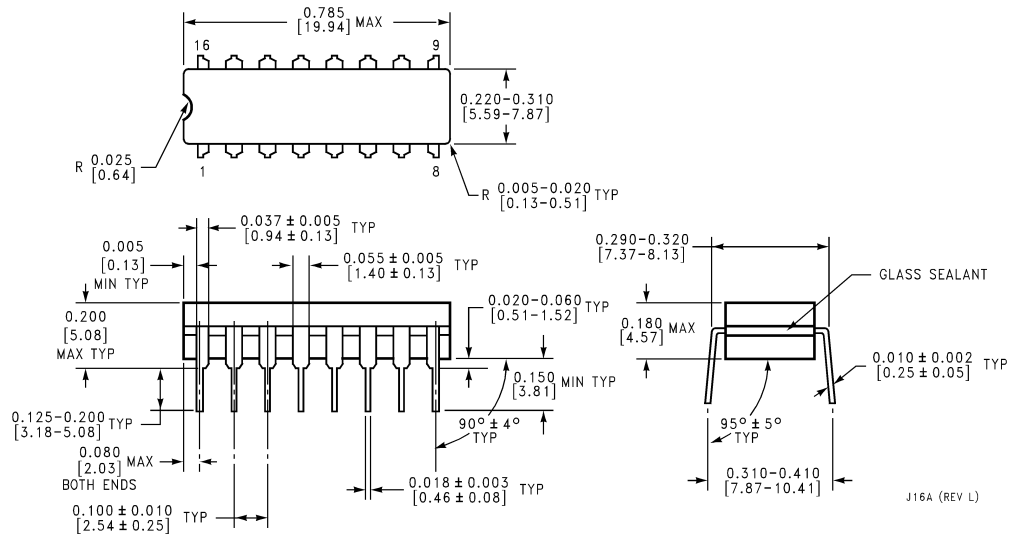

**16-Lead Ceramic Dual-in-Line Package**  
**Order Number LM2991J-QMLV**  
**5962-9650501VEA**  
**Order Number LM2991J-QML**  
**5962-9650501QEA**  
**NS Package Number J16A**

J16A (REV L)

**Physical Dimensions** inches (millimeters) unless otherwise noted (Continued)

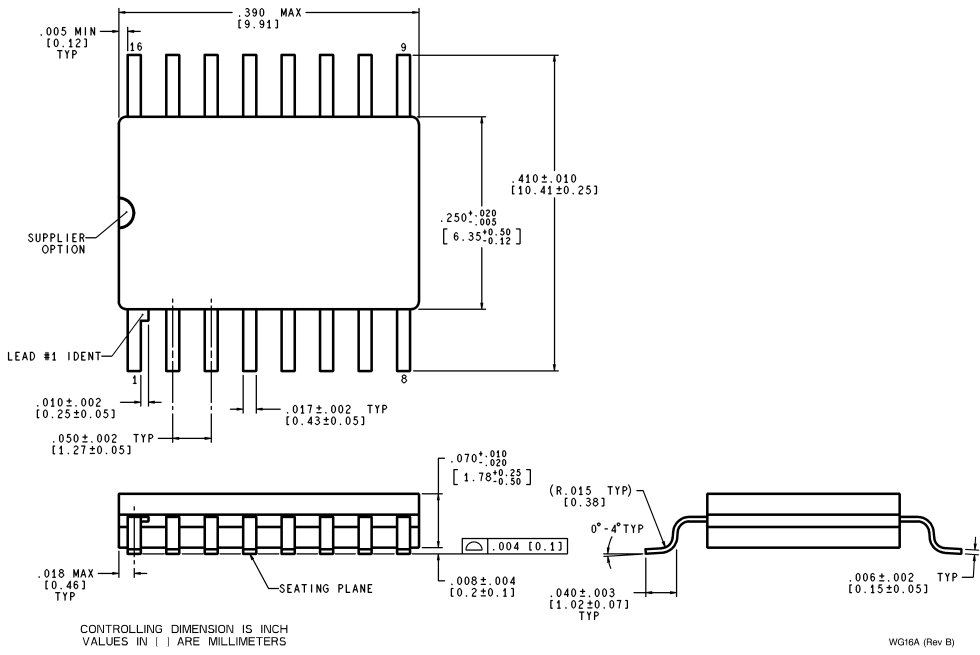

**16-Lead Ceramic Surface-Mount Package**  
**Order Number LM2991WG-QML**  
**5962-9650501QXA**  
**NS Package Number WG16A**

**LIFE SUPPORT POLICY**

NATIONAL'S PRODUCTS ARE NOT AUTHORIZED FOR USE AS CRITICAL COMPONENTS IN LIFE SUPPORT DEVICES OR SYSTEMS WITHOUT THE EXPRESS WRITTEN APPROVAL OF THE PRESIDENT AND GENERAL COUNSEL OF NATIONAL SEMICONDUCTOR CORPORATION. As used herein:

1. Life support devices or systems are devices or systems which, (a) are intended for surgical implant into the body, or (b) support or sustain life, and whose failure to perform when properly used in accordance with instructions for use provided in the labeling, can be reasonably expected to result in a significant injury to the user.
2. A critical component is any component of a life support device or system whose failure to perform can be reasonably expected to cause the failure of the life support device or system, or to affect its safety or effectiveness.

 <p><b>National Semiconductor Corporation</b>  Americas  Tel: 1-800-272-9959  Fax: 1-800-737-7018  Email: support@nsc.com  www.national.com</p>	<p><b>National Semiconductor Europe</b>  Fax: +49 (0) 1 80-530 85 86  Email: europe.support@nsc.com  Deutsch Tel: +49 (0) 1 80-530 85 85  English Tel: +49 (0) 1 80-532 78 32  Français Tel: +49 (0) 1 80-532 93 58  Italiano Tel: +49 (0) 1 80-534 16 80</p>	<p><b>National Semiconductor Asia Pacific Customer Response Group</b>  Tel: 65-2544466  Fax: 65-2504466  Email: sea.support@nsc.com</p>	<p><b>National Semiconductor Japan Ltd.</b>  Tel: 81-3-5639-7560  Fax: 81-3-5639-7507</p>
--	---	---	---

National does not assume any responsibility for use of any circuitry described, no circuit patent licenses are implied and National reserves the right at any time without notice to change said circuitry and specifications.