

## LM2825 SIMPLE SWITCHER® 1A DC-DC Converter in 24-Pin DIP Package

### General Description

The LM2825 is a complete 1A DC-DC Buck converter packaged in a 24-lead molded Dual-In-Line integrated circuit package.

Contained within the package are all the active and passive components for a high efficiency step-down (buck) switching regulator. Available in fixed output voltages of 3.3V and 5V, these devices can provide up to 1A of load current with fully guaranteed electrical specifications over the full operating temperature range.

Self-contained, this converter is also fully protected from output fault conditions, such as excessive load current, short circuits, or excessive temperatures.

### Highlights

- Integrated circuit reliability
- MTBF over 20 million hours
- Radiated EMI meets Class B stipulated by CISPR 22
- High power density, 35 W/in<sup>3</sup>
- 24-pin DIP package profile (1.25 x 0.54 x 0.26 inches)
- Package weight 6 grams
- No external components required

### Features

- Minimum design time required
- 3.3V and 5V fixed output versions
- Guaranteed 1A output current
- Wide input voltage range, up to 40V
- Low-power standby mode, I<sub>Q</sub> typically 65  $\mu$ A
- High efficiency, typically 80%
- $\pm 4\%$  output voltage tolerance
- Excellent line and load regulation
- TTL shutdown capability/programmable Soft-start
- Thermal shutdown and current limit protection

### Applications

- Simple high-efficiency step-down (buck) regulator
- On-card switching regulators
- Efficient pre-regulator for linear regulators
- Distributed power systems
- DC/DC module replacement



TL/H/12661-27

### Standard Application

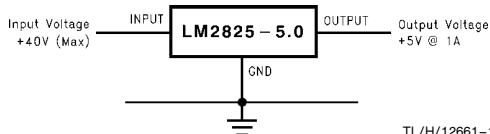

TL/H/12661-1

### Connection Diagram

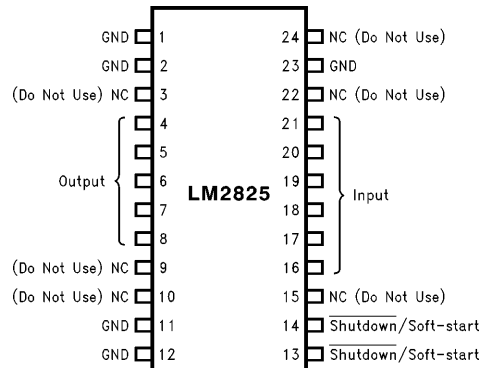

TL/H/12661-2

Note: "NC (Do not use)" pins: See Figure 5.

Top View

### Radiated EMI

Radiated emission of electromagnetic fields is measured at 10m distance. The emission levels are within the Class B limits stipulated by CISPR 22.

30...230 MHz	30 dB $\mu$ V/m
230...1000 MHz	37 dB $\mu$ V/m
1...10 GHz	46 dB $\mu$ V/m

### Order Information

Order Number **LM2825N-3.3** or **LM2825N-5.0**  
See NS Package Number **NA24F**

SIMPLE SWITCHER® is a registered trademark of National Semiconductor Corporation.

### Absolute Maximum Ratings (Note 1)

If Military/Aerospace specified devices are required, please contact the National Semiconductor Sales Office/Distributors for availability and specifications.

Maximum Input Supply ( $V_{IN}$ )	+ 45V
SD/SS Pin Input Voltage (Note 2)	6V
Output Voltage to Ground (steady state)	-1V
Power Dissipation	Internally Limited
Storage Temperature Range	-40°C to +125°C
ESD Susceptibility	
Human Body Model (Note 3)	2 kV
Lead Temperature (Soldering 10 sec.)	260°C

### Operating Ratings

Ambient Temperature Range	0°C ≤ $T_A$ ≤ +70°C
Junction Temperature Range	0°C ≤ $T_J$ ≤ +125°C
Input Supply Voltage (3.3V version)	4.75V to 40V
Input Supply Voltage (5V version)	7V to 40V

### LM2825-3.3 Electrical Characteristics

Specifications with standard type face are for  $T_A = 25^\circ\text{C}$ , and those with **boldface type** apply over **full Operating Temperature Range**. (Note 4) Test Circuit *Figure 2*.

Symbol	Parameter	Conditions	LM2825-3.3		Units (Limits)
			Typical (Note 5)	Limit (Note 6)	
$V_{OUT}$	Output Voltage	$4.75\text{V} \leq V_{IN} \leq 40\text{V}$ , $0.1\text{A} \leq I_{LOAD} \leq 1\text{A}$	3.3	3.168/ <b>3.135</b> 3.432/ <b>3.465</b>	V V(min) V(max)
	Line Regulation	$4.75\text{V} \leq V_{IN} \leq 40\text{V}$ $I_{LOAD} = 100\text{mA}$	1.5		mV
	Load Regulation	$0.1\text{A} \leq I_{LOAD} \leq 1\text{A}$ $V_{IN} = 12\text{V}$	8		mV
	Output Ripple Voltage	$V_{IN} = 12\text{V}$ , $I_{LOAD} = 1\text{A}$	40		mV p-p
$\eta$	Efficiency	$V_{IN} = 12\text{V}$ , $I_{LOAD} = 1\text{A}$	78		%

### LM2825-5.0 Electrical Characteristics

Specifications with standard type face are for  $T_A = 25^\circ\text{C}$ , and those with **boldface type** apply over **full Operating Temperature Range**. (Note 4) Test Circuit *Figure 2*.

Symbol	Parameter	Conditions	LM2825-5.0		Units (Limits)
			Typical (Note 5)	Limit (Note 6)	
$V_{OUT}$	Output Voltage	$7\text{V} \leq V_{IN} \leq 40\text{V}$ , $0.1\text{A} \leq I_{LOAD} \leq 1\text{A}$	5.0	4.800/ <b>4.750</b> 5.200/ <b>5.250</b>	V V(min) V(max)
	Line Regulation	$7\text{V} \leq V_{IN} \leq 40\text{V}$ $I_{LOAD} = 100\text{mA}$	2.7		mV
	Load Regulation	$0.1\text{A} \leq I_{LOAD} \leq 1\text{A}$ $V_{IN} = 12\text{V}$	8		mV
	Output Ripple Voltage	$V_{IN} = 12\text{V}$ , $I_{LOAD} = 1\text{A}$	40		mV p-p
$\eta$	Efficiency	$V_{IN} = 12\text{V}$ , $I_{LOAD} = 1\text{A}$	80		%

## All Output Voltage Versions Electrical Characteristics

Specifications with standard type face are for  $T_A = 25^\circ\text{C}$ , and those with **boldface type** apply over **full Operating Range**. Unless otherwise specified,  $V_{IN} = 12\text{V}$ ,  $I_{LOAD} = 100\text{ mA}$ .

Symbol	Parameter	Conditions	LM2825-XX		Units (Limits)
			Typical (Note 5)	Limit (Note 6)	
$I_{CL}$	DC Output Current Limit	$V_{IN} = 12\text{V}$ , $R_L = 0\Omega$	1.4	1.2 2.4	A A(min) A(max)
$I_Q$	Operating Quiescent Current	SD/SS Pin = 3V (Note 7)	5	10	mA mA(max)
$I_{STBY}$	Standby Quiescent Current	SD/SS Pin = 0V (Note 7)	65	200	$\mu\text{A}$ $\mu\text{A(max)}$
$f_O$	Oscillator Frequency	(Note 8)	150		kHz
$\theta_{JA}$	Thermal Resistance	Junction to Ambient (Note 9)	30		$^\circ\text{C/W}$

### SHUTDOWN/SOFT-START CONTROL Test Circuit *Figure 2*

$V_{SD}$	Shutdown Threshold Voltage	Low (Shutdown Mode) High (Soft-start Mode)	1.3	<b>0.6</b> <b>2.0</b>	V V(max) V(min)
$V_{SS}$	Soft-start Voltage	$V_{OUT} = 20\%$ of Nominal Output Voltage $V_{OUT} = 100\%$ of Nominal Output Voltage	2 3		V
$I_{SD}$	Shutdown Current	$V_{SHUTDOWN} = 0.5\text{V}$ (Note 7)	5	10	$\mu\text{A}$ $\mu\text{A(max)}$
$I_{SS}$	Soft-start Current	$V_{SOFT-START} = 2.5\text{V}$ (Note 7)	1.6	5	$\mu\text{A}$ $\mu\text{A(max)}$

**Note 1:** Absolute Maximum Ratings indicate limits beyond which damage to the device may occur. Operating Ratings indicate conditions for which the device is intended to be functional, but do not guarantee specific performance limits. For guaranteed specifications and test conditions, see the Electrical Characteristics.

**Note 2:** Voltage internally clamped. If clamp voltage is exceeded, limit current to a maximum of 5 mA.

**Note 3:** The human body model is a 100 pF capacitor discharged through a 1.5k resistor into each pin.

**Note 4:** When the LM2825 is used as shown in *Figure 2* test circuit, system performance will be as shown in Electrical Characteristics.

**Note 5:** Typical numbers are at  $25^\circ\text{C}$  and represent the most likely norm.

**Note 6:** All limits guaranteed at room temperature (standard type face) and at **temperature extremes (bold type face)**. All room temperature limits are 100% production tested. All limits at **temperature extremes** are guaranteed via correlation using standard Statistical Quality Control (SQC) methods. All limits are used to calculate Average Outgoing Quality Level (AOQL).

**Note 7:**  $I_{LOAD} = 0\text{A}$ .

**Note 8:** The switching frequency is reduced when the second stage current limit is activated. The amount of reduction is determined by the severity of current overload.

**Note 9:** Junction to ambient thermal resistance (no external heat sink) for the DIP-24 package with the leads soldered to a printed circuit board with (1 oz.) copper area of approximately  $2\text{ in}^2$ .

# Typical Performance Characteristics

(Circuit of Figure 2) Unless otherwise specified,  $V_{IN} = 12V$ ,  $I_{LOAD} = 100\text{ mA}$

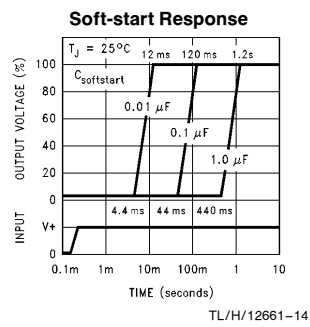
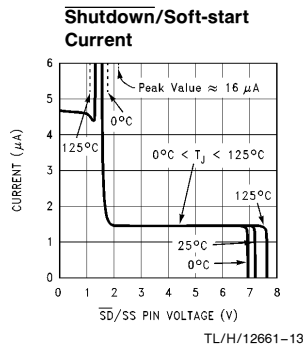
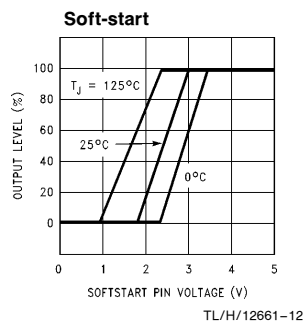
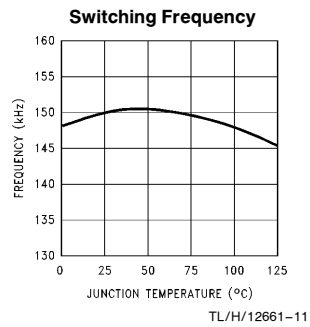
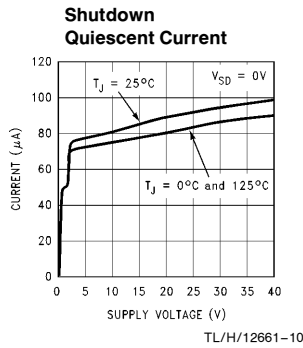
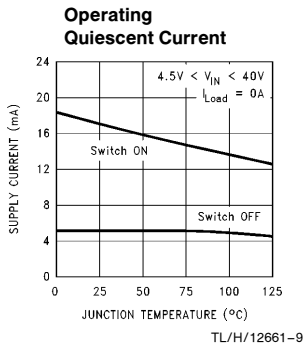
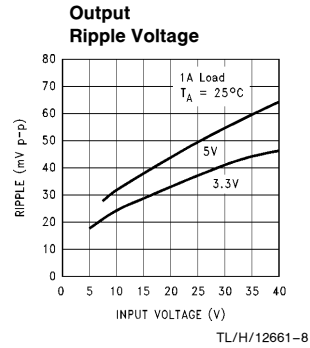
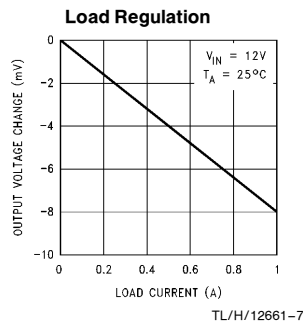
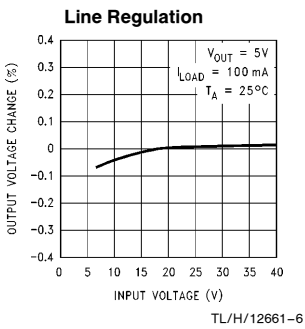
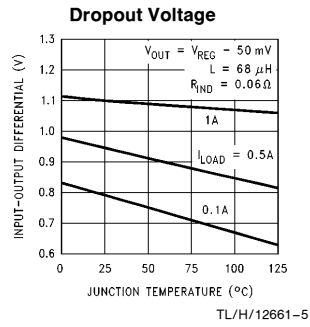
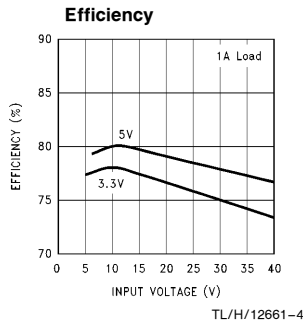
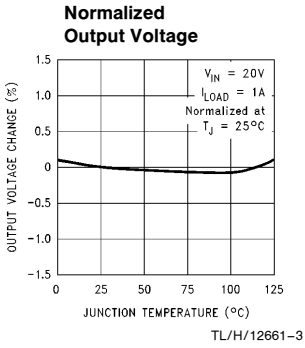

## Typical Performance Characteristics

(Circuit of Figure 2) Unless otherwise specified,  $V_{IN} = 12V$ ,  $I_{LOAD} = 100\text{ mA}$  (Continued)

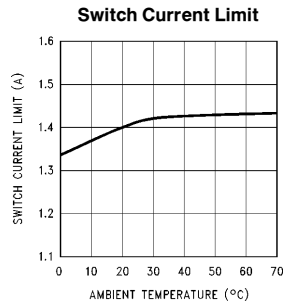

TL/H/12661-28

**Load Transient Response for Continuous Mode**  
 $V_{IN} = 20V$ ,  $V_{OUT} = 5V$ ,  $I_L = 250\text{ mA to }750\text{ mA}$

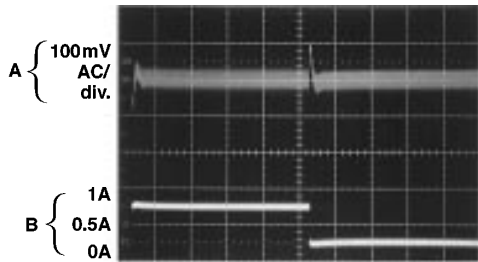

TL/H/12661-23

A: Output Voltage 100 mV/div (AC)  
 B: 250 mA to 750 mA Load Pulse  
 Horizontal Time Base: 200  $\mu\text{s}/\text{div}$

**Load Transient Response for Discontinuous Mode**  
 $V_{IN} = 20V$ ,  $V_{OUT} = 5V$ ,  $I_L = 40\text{ mA to }140\text{ mA}$

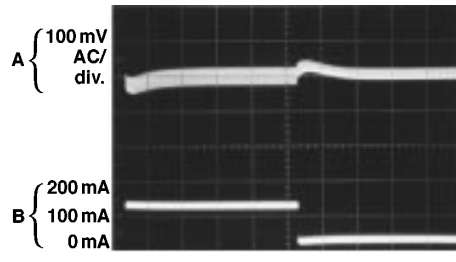

TL/H/12661-24

A: Output Voltage 100 mV/div (AC)  
 B: 40 mA to 140 mA Load Pulse  
 Horizontal Time Base: 200  $\mu\text{s}/\text{div}$

**FIGURE 1. Typical Load Transient Response**

## Test Circuit

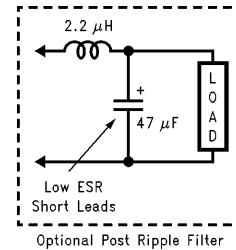
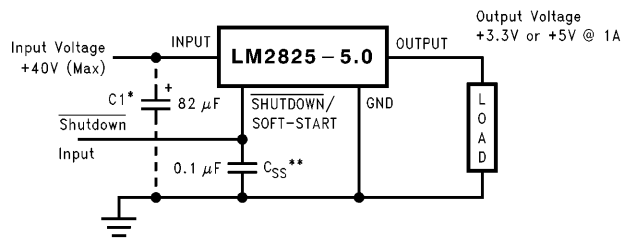

TL/H/12661-19

\*Optional—Required if package is more than 6" away from main filter or bypass capacitor.

\*\*Optional Soft-start Capacitor

$V_{IN} = 40V$  (max)  
 $V_{OUT} = 3.3V$  or  $5V$   
 $I_{LOAD} = 1A$

**FIGURE 2. Standard Test Circuit**

## Application Information

### OPTIONAL EXTERNAL COMPONENTS

#### SOFT-START CAPACITOR

**C<sub>SS</sub>**: A capacitor on this pin provides the regulator with a Soft-start feature (slow start-up). The current drawn from the source starts out at a low average level with narrow pulses, and ramps up in a controlled manner as the pulses expand to their steady-state width. This reduces the startup current considerably, and delays and slows down the output voltage rise time.

It is especially useful in situations where the input power source is limited in the amount of current it can deliver, since you avoid loading down this type of power supply.

Under some operating conditions, a Soft-start capacitor is required for proper operation. *Figure 3* indicates the input voltage and ambient temperature conditions for which a Soft-start capacitor may be required.

This curve is typical for full 1A loads and can be used as a guideline. As the output current decreases, the operating area requiring a Soft-start capacitor decreases. Capacitor values between 0.1  $\mu$ F and 1  $\mu$ F are recommended. Tantalum or ceramic capacitors are appropriate for this application.

#### INPUT CAPACITOR

**C<sub>IN</sub>**: An optional input capacitor is required if the package is more than 6" away from the main filter or bypass capacitor. A low ESR aluminum or tantalum bypass capacitor is recommended between the input pin and ground to prevent large voltage transients from appearing at the input. In addition, to be conservative, the RMS current rating of the input capacitor should be selected to be at least  $\frac{1}{2}$  the DC load current. With a 1A load, a capacitor with a RMS current rating of at least 500 mA is recommended.

The voltage rating should be approximately 1.25 times the maximum input voltage. With a nominal input voltage of 12V, an aluminum electrolytic capacitor (Panasonic HFQ series or Nichicon PL series or equivalent) with a voltage rating greater than 15V ( $1.25 \times V_{IN}$ ) would be needed.

Solid tantalum input capacitors should only be used where the input source is impedance current limited. High  $dV/dt$  applied at the input can cause excessive charge current through low ESR tantalum capacitors. This high charge current can result in shorting within the capacitor. It is recommended that they be surge current tested by the manufacturer. The TPS series available from AVX, and the 593D series from Sprague are both surge current tested.

Use caution when using ceramic capacitors for input bypassing, because it may cause ringing at the  $V_{IN}$  pin.

#### SHUTDOWN

The circuit shown in *Figure 4* shows 2 circuits for the Shutdown/Soft-start feature using different logic signals for shutdown and using a 0.1  $\mu$ F Soft-start capacitor.

#### THERMAL CONSIDERATIONS

The LM2825 is available in a 24-pin through hole DIP. The package is molded plastic with a copper lead frame. When the package is soldered to the PC board, the copper and the board are the heat sink for the LM2825.

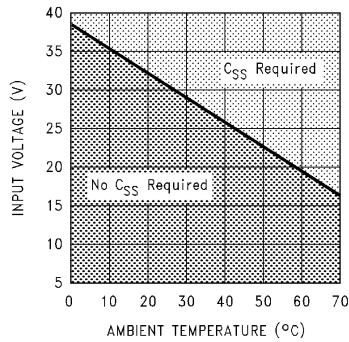

TL/H/12661-22

FIGURE 3. Usage of the Soft-start Capacitor

## Application Information (Continued)

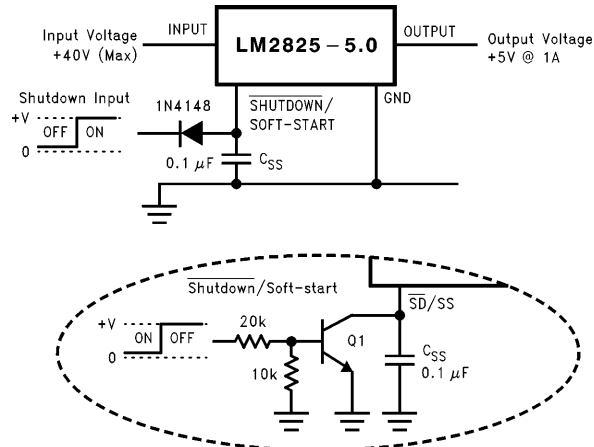

TL/H/12661-25

FIGURE 4. Typical Circuits Using Shutdown/Soft-Start Features

### TYPICAL THROUGH HOLE PC BOARD LAYOUT (2X SIZE), SINGLE SIDED, THROUGH HOLE PLATED

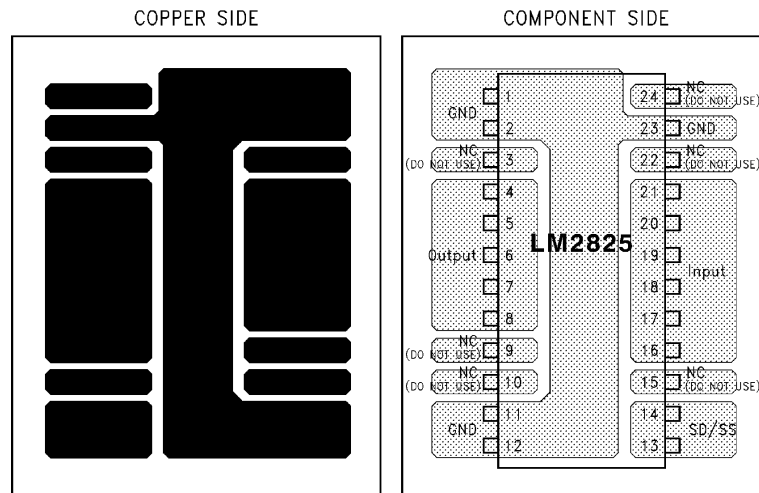

TL/H/12661-26

**Note:** Holes are not shown.

“No Connect Pins” are connected to copper pads for thermal reasons only and must remain electrically isolated.

FIGURE 5. 2X Printed Circuit Board Layout

**LM2825 SIMPLE SWITCHER 1A DC-DC Converter in 24-Pin DIP Package**

**Physical Dimensions** inches (millimeters) unless otherwise noted

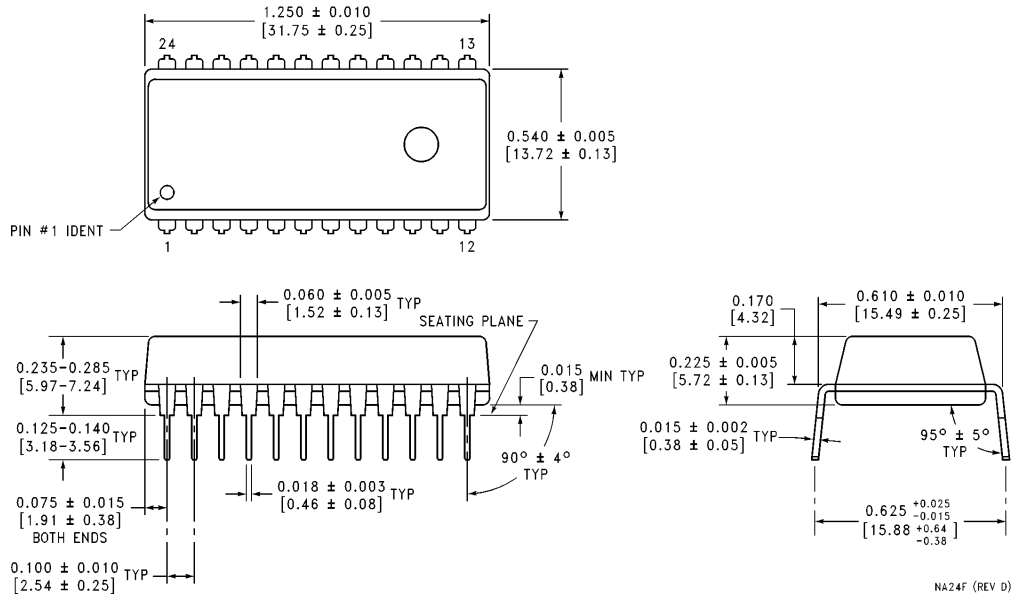

**24-Lead (0.600" Wide) Molded Dual-In-Line Package**  
**Order Number LM2825N-3.3 or LM2825N-5.0**  
**NS Package Number NA24F**

NA24F (REV D)

**LIFE SUPPORT POLICY**

NATIONAL'S PRODUCTS ARE NOT AUTHORIZED FOR USE AS CRITICAL COMPONENTS IN LIFE SUPPORT DEVICES OR SYSTEMS WITHOUT THE EXPRESS WRITTEN APPROVAL OF THE PRESIDENT OF NATIONAL SEMICONDUCTOR CORPORATION. As used herein:

1. Life support devices or systems are devices or systems which, (a) are intended for surgical implant into the body, or (b) support or sustain life, and whose failure to perform, when properly used in accordance with instructions for use provided in the labeling, can be reasonably expected to result in a significant injury to the user.
2. A critical component is any component of a life support device or system whose failure to perform can be reasonably expected to cause the failure of the life support device or system, or to affect its safety or effectiveness.



**National Semiconductor Corporation**  
 1111 West Bardin Road  
 Arlington, TX 76017  
 Tel: (800) 272-9959  
 Fax: (800) 737-7018

<http://www.national.com>

**National Semiconductor Europe**

Fax: +49 (0) 180-530 85 86  
 Email: [europe.support@nsc.com](mailto:europe.support@nsc.com)  
 Deutsch Tel: +49 (0) 180-530 85 85  
 English Tel: +49 (0) 180-532 78 32  
 Français Tel: +49 (0) 180-532 93 58  
 Italiano Tel: +49 (0) 180-534 16 80

**National Semiconductor Hong Kong Ltd.**

19th Floor, Straight Block,  
 Ocean Centre, 5 Canton Rd.  
 Tsimshatsui, Kowloon  
 Hong Kong  
 Tel: (852) 2737-1600  
 Fax: (852) 2736-9960

**National Semiconductor Japan Ltd.**

Tel: 81-043-299-2308  
 Fax: 81-043-299-2408

National does not assume any responsibility for use of any circuitry described, no circuit patent licenses are implied and National reserves the right at any time without notice to change said circuitry and specifications.