

## Sideview LED, 5 mm Tinted Diffused

Color	Type	Technology	Angle of Half Intensity $\pm\varphi$
Red	TLPR5600	GaAsP on GaAs	80°
High efficiency red	TLPH5600	GaAsP on GaP	80°
Yellow	TLPY5600	GaAsP on GaP	80°
Green	TLPG5600	GaP on GaP	80°
Pure green	TLPP5600	GaP on GaP	80°

### Features

- Even luminance of the emitting surface
- Wide viewing angle
- Yellow and green color categorized
- For DC and pulse operation

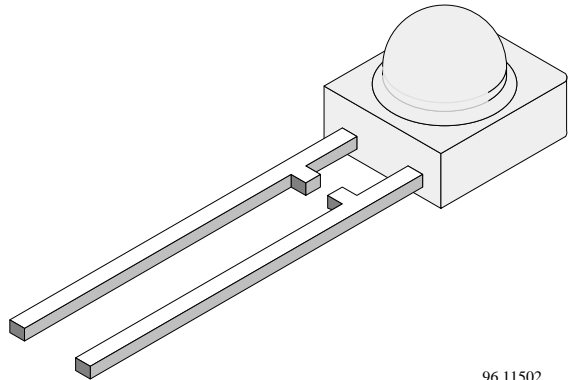

96 11502

### Applications

Indicating and illumination purposes

### Absolute Maximum Ratings

$T_{amb} = 25^{\circ}\text{C}$ , unless otherwise specified

**TLPR5600 , TLPH5600 , TLPY5600 , TLPG5600 , TLPP5600**

Parameter	Test Conditions	Type	Symbol	Value	Unit
Reverse voltage			$V_R$	6	V
DC forward current		TLPR5600	$I_F$	50	mA
		TLPH5600	$I_F$	30	mA
		TLPY5600	$I_F$	30	mA
		TLPG5600	$I_F$	30	mA
		TLPP5600	$I_F$	30	mA
Surge forward current	$t_p \leq 10 \mu\text{s}$		$I_{FSM}$	1	A
Power dissipation	$T_{amb} \leq 60^{\circ}\text{C}$		$P_V$	100	mW
Junction temperature			$T_j$	100	$^{\circ}\text{C}$
Operating temperature range			$T_{amb}$	-40 to +100	$^{\circ}\text{C}$
Storage temperature range			$T_{stg}$	-55 to +100	$^{\circ}\text{C}$
Soldering temperature	$t \leq 5 \text{ s}$ , 2 mm from body	$T_{sd}$	$T_{sd}$	260	$^{\circ}\text{C}$
Thermal resistance junction/ambient		$R_{thJA}$	$R_{thJA}$	400	K/W

### Optical and Electrical Characteristics

$T_{amb} = 25^{\circ}\text{C}$ , unless otherwise specified

#### Red (TLPR5600)

Parameter	Test Conditions	Type	Symbol	Min	Typ	Max	Unit
Luminous intensity <sup>1)</sup>	$I_F = 10 \text{ mA}$		$I_V$	0.25	0.5		mcd
Dominant wavelength	$I_F = 10 \text{ mA}$		$\lambda_d$		645		nm
Peak wavelength	$I_F = 10 \text{ mA}$		$\lambda_p$		660		nm
Angle of half intensity	$I_F = 10 \text{ mA}$		$\phi$		$\pm 80$		deg
Forward voltage	$I_F = 20 \text{ mA}$		$V_F$		1.6	2	V
Reverse voltage	$I_R = 10 \mu\text{A}$		$V_R$	6	15		V
Junction capacitance	$V_R = 0, f = 1 \text{ MHz}$		$C_j$		50		pF

<sup>1)</sup> in one Packing Unit  $I_{V\text{Min.}}/I_{V\text{Max.}} \leq 0.5$

#### High efficiency red (TLPH5600)

Parameter	Test Conditions	Type	Symbol	Min	Typ	Max	Unit
Luminous intensity <sup>1)</sup>	$I_F = 10 \text{ mA}$		$I_V$	0.63	1.5		mcd
Dominant wavelength	$I_F = 10 \text{ mA}$		$\lambda_d$	612		625	nm
Peak wavelength	$I_F = 10 \text{ mA}$		$\lambda_p$		635		nm
Angle of half intensity	$I_F = 10 \text{ mA}$		$\phi$		$\pm 80$		deg
Forward voltage	$I_F = 20 \text{ mA}$		$V_F$		2	3	V
Reverse voltage	$I_R = 10 \mu\text{A}$		$V_R$	6	15		V
Junction capacitance	$V_R = 0, f = 1 \text{ MHz}$		$C_j$		50		pF

<sup>1)</sup> in one Packing Unit  $I_{V\text{Min.}}/I_{V\text{Max.}} \leq 0.5$

#### Yellow (TLPY5600)

Parameter	Test Conditions	Type	Symbol	Min	Typ	Max	Unit
Luminous intensity <sup>1)</sup>	$I_F = 10 \text{ mA}$		$I_V$	0.63	1.5		mcd
Dominant wavelength	$I_F = 10 \text{ mA}$		$\lambda_d$	581		594	nm
Peak wavelength	$I_F = 10 \text{ mA}$		$\lambda_p$		585		nm
Angle of half intensity	$I_F = 10 \text{ mA}$		$\phi$		$\pm 80$		deg
Forward voltage	$I_F = 20 \text{ mA}$		$V_F$		2.4	3	V
Reverse voltage	$I_R = 10 \mu\text{A}$		$V_R$	6	15		V
Junction capacitance	$V_R = 0, f = 1 \text{ MHz}$		$C_j$		50		pF

<sup>1)</sup> in one Packing Unit  $I_{V\text{Min.}}/I_{V\text{Max.}} \leq 0.5$

#### Green (TLPG5600)

Parameter	Test Conditions	Type	Symbol	Min	Typ	Max	Unit
Luminous intensity <sup>1)</sup>	$I_F = 10 \text{ mA}$		$I_V$	0.63	1.5		mcd
Dominant wavelength	$I_F = 10 \text{ mA}$		$\lambda_d$	562		575	nm
Peak wavelength	$I_F = 10 \text{ mA}$		$\lambda_p$		565		nm
Angle of half intensity	$I_F = 10 \text{ mA}$		$\phi$		$\pm 80$		deg
Forward voltage	$I_F = 20 \text{ mA}$		$V_F$		2.4	3	V
Reverse voltage	$I_R = 10 \mu\text{A}$		$V_R$	6	15		V
Junction capacitance	$V_R = 0, f = 1 \text{ MHz}$		$C_j$		50		pF

<sup>1)</sup> in one Packing Unit  $I_{V\text{Min.}}/I_{V\text{Max.}} \leq 0.5$



Pure green (TLPP5600)

Parameter	Test Conditions	Type	Symbol	Min	Typ	Max	Unit
Luminous intensity <sup>1)</sup>	$I_F = 10 \text{ mA}$		$I_V$	0.63	1.6		mcd
Dominant wavelength	$I_F = 10 \text{ mA}$		$\lambda_d$	555		565	nm
Peak wavelength	$I_F = 10 \text{ mA}$		$\lambda_p$		555		nm
Angle of half intensity	$I_F = 10 \text{ mA}$		$\phi$		$\pm 80$		deg
Forward voltage	$I_F = 20 \text{ mA}$		$V_F$		2.4	3	V
Reverse voltage	$I_R = 10 \mu\text{A}$		$V_R$	6	15		V
Junction capacitance	$V_R = 0, f = 1 \text{ MHz}$		$C_j$		50		pF

<sup>1)</sup> in one Packing Unit  $I_V \text{ Min.} / I_V \text{ Max.} \leq 0.5$

**Typical Characteristics** ( $T_{\text{amb}} = 25^\circ\text{C}$ , unless otherwise specified)

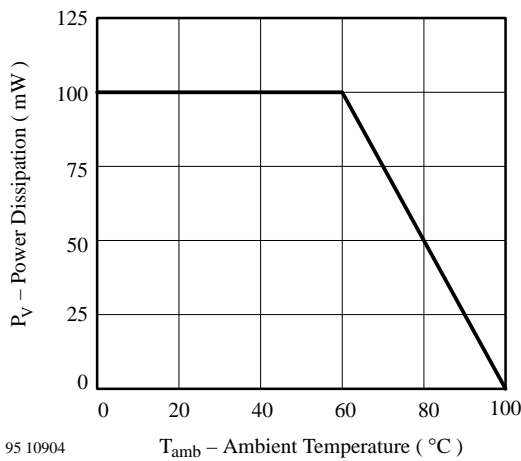

Figure 1. Power Dissipation vs. Ambient Temperature

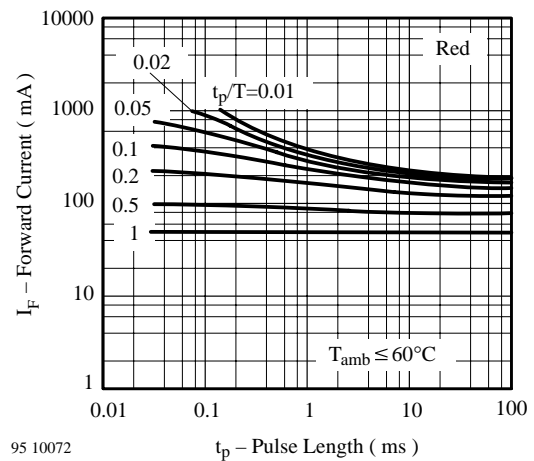

Figure 3. Forward Current vs. Pulse Length

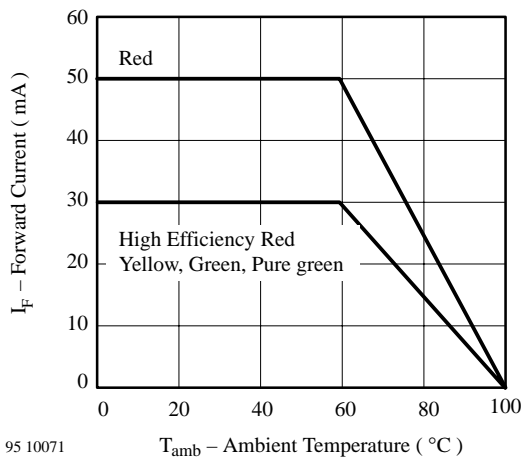

Figure 2. Forward Current vs. Ambient Temperature

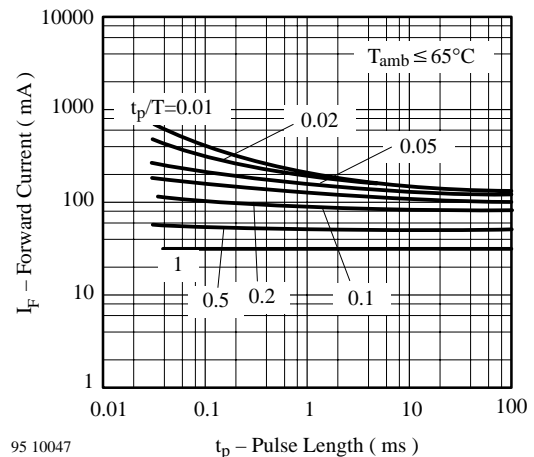
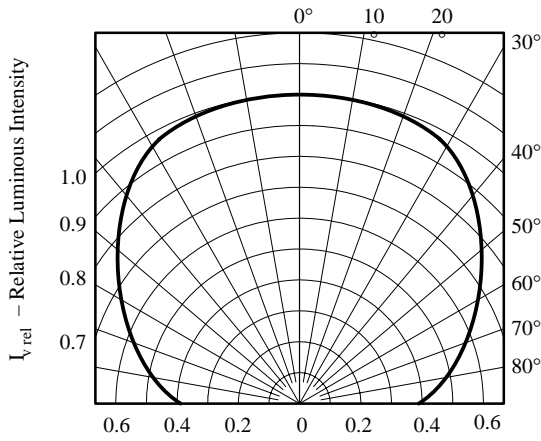
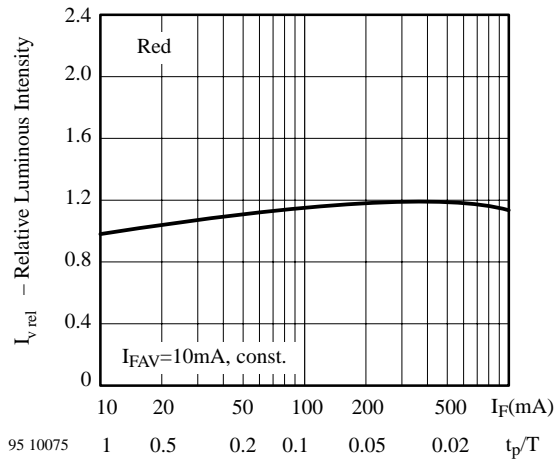

Figure 4. Forward Current vs. Pulse Length



95 10078

Figure 5. Rel. Luminous Intensity vs. Angular Displacement



95 10075

Figure 8. Rel. Lumin. Intensity vs. Forw. Current/Duty Cycle

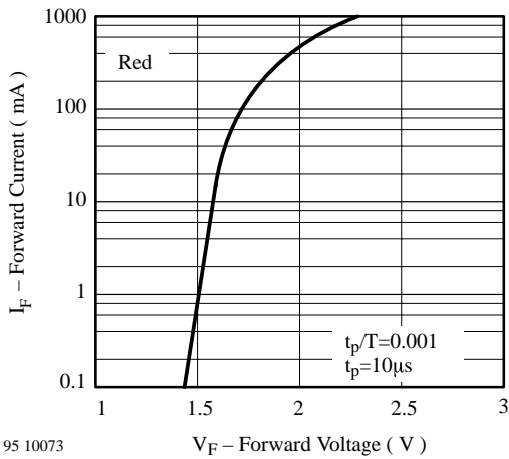

95 10073

Figure 6. Forward Current vs. Forward Voltage

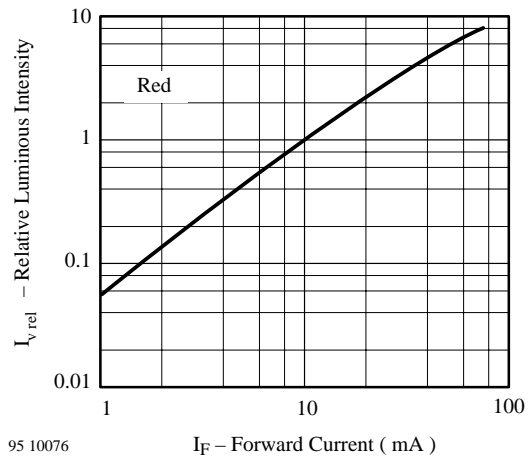

95 10076

Figure 9. Relative Luminous Intensity vs. Forward Current

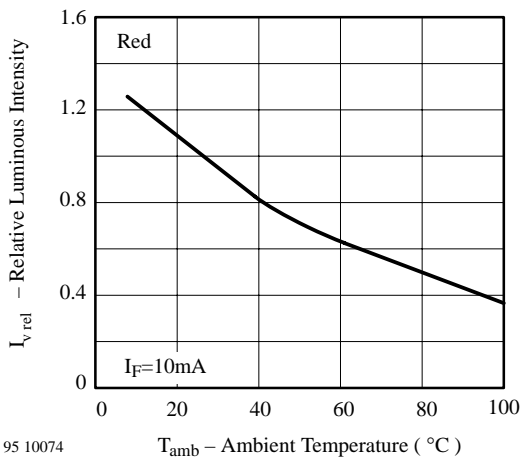

95 10074

Figure 7. Rel. Luminous Intensity vs. Ambient Temperature

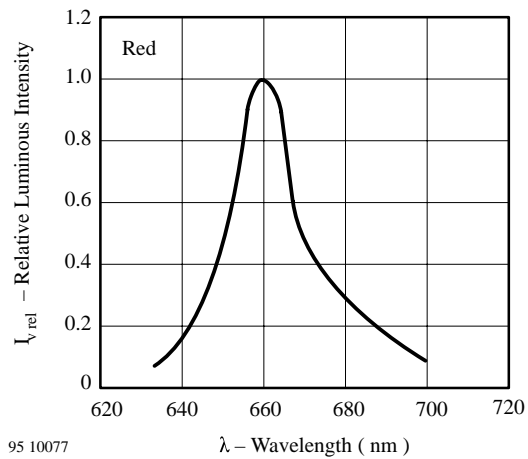

95 10077

Figure 10. Relative Luminous Intensity vs. Wavelength

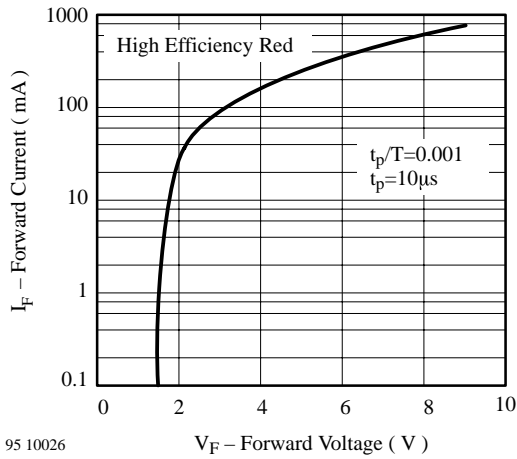

95 10026

Figure 11. Forward Current vs. Forward Voltage

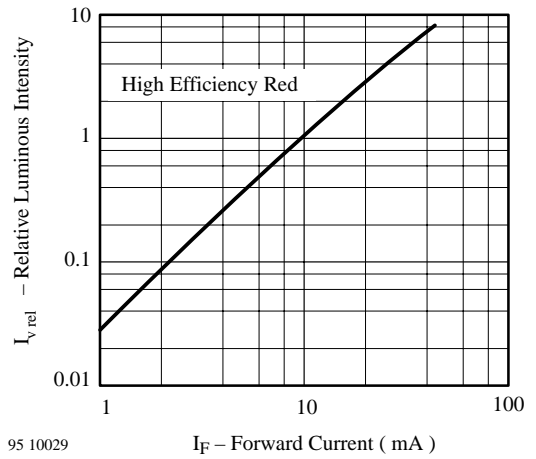

95 10029

Figure 14. Relative Luminous Intensity vs. Forward Current

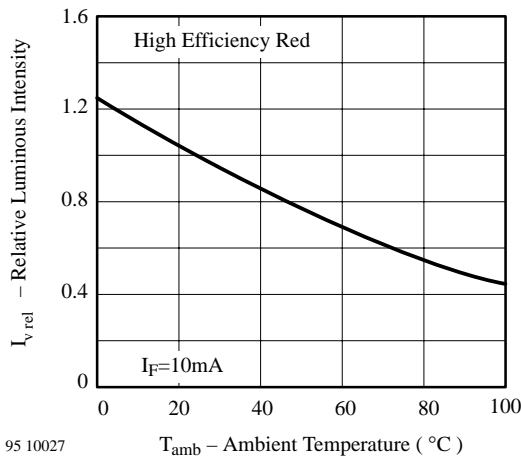

95 10027

Figure 12. Rel. Luminous Intensity vs. Ambient Temperature

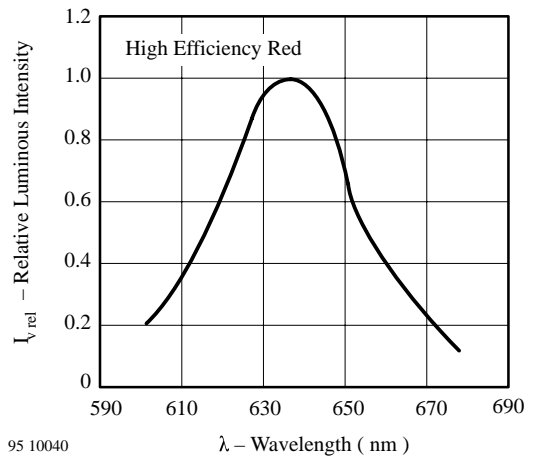

95 10040

Figure 15. Forward Current vs. Forward Voltage

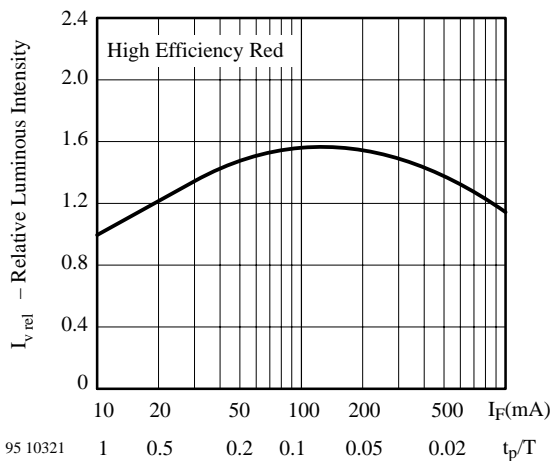

95 10321

Figure 13. Rel. Lumin. Intensity vs. Forw. Current/Duty Cycle

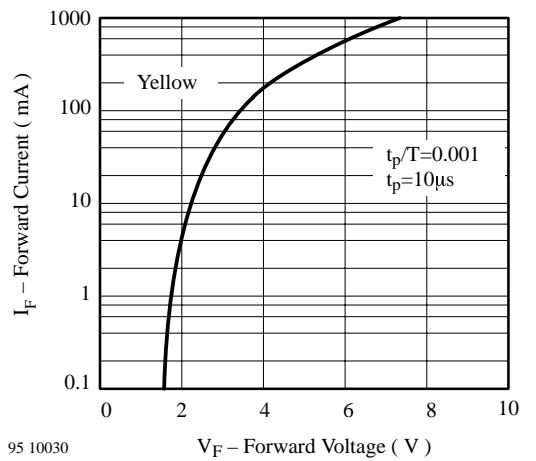

95 10030

Figure 16. Forward Current vs. Forward Voltage

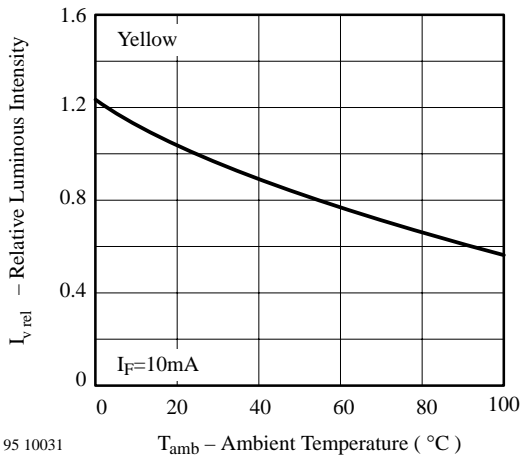

95 10031

Figure 17. Rel. Luminous Intensity vs. Ambient Temperature

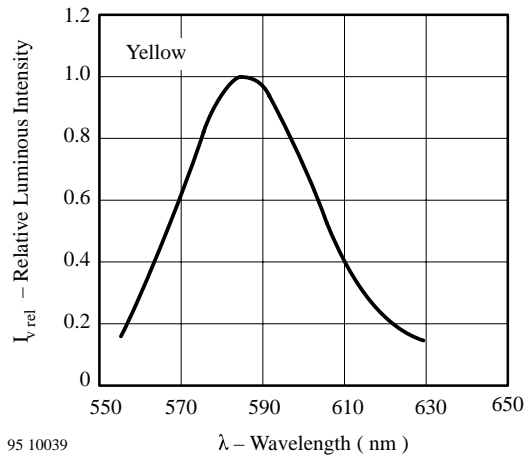

95 10039

Figure 20. Relative Luminous Intensity vs. Wavelength

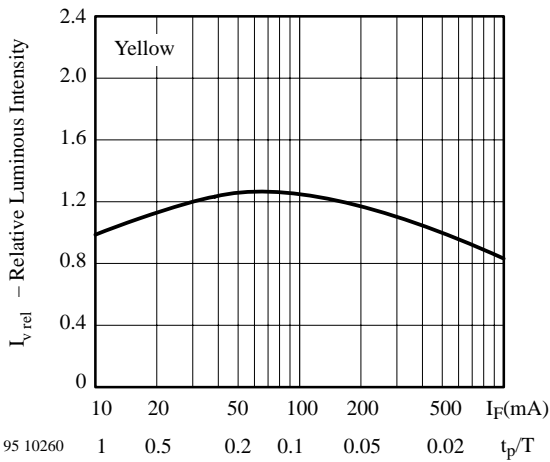

95 10260

Figure 18. Rel. Lumin. Intensity vs. Forw. Current/Duty Cycle

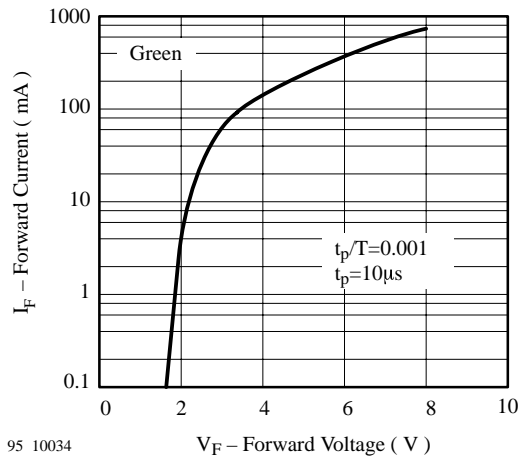

95 10034

Figure 21. Forward Current vs. Forward Voltage

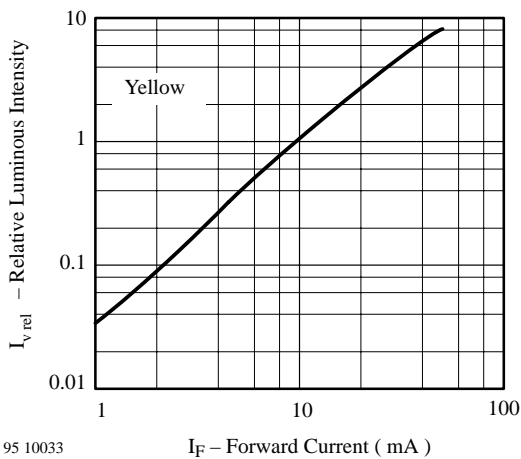

95 10033

Figure 19. Relative Luminous Intensity vs. Forward Current

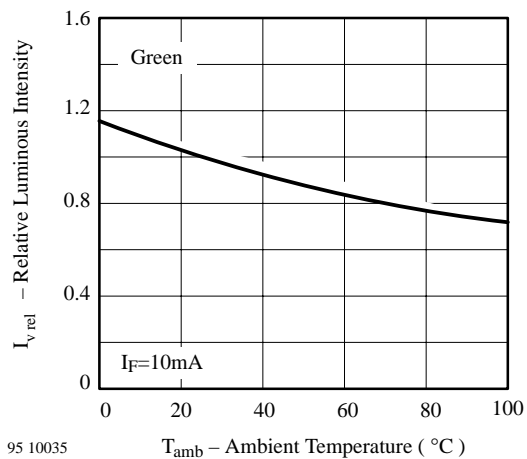

95 10035

Figure 22. Rel. Luminous Intensity vs. Ambient Temperature

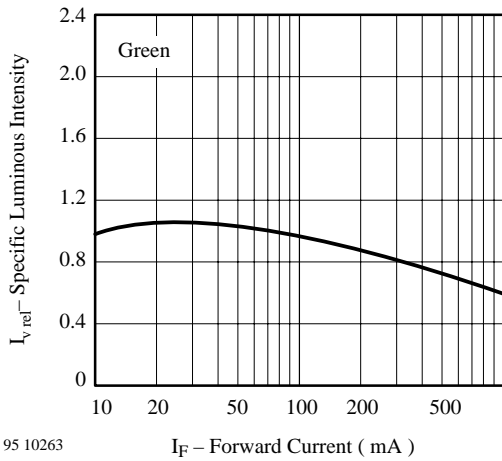

95 10263

Figure 23. Specific Luminous Intensity vs. Forward Current

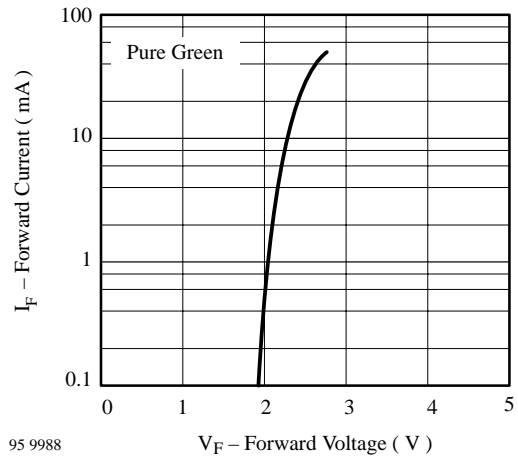

95 9988

Figure 26. Forward Current vs. Forward Voltage

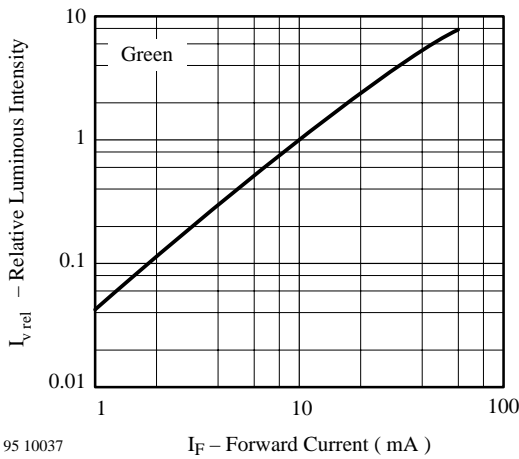

95 10037

Figure 24. Relative Luminous Intensity vs. Forward Current

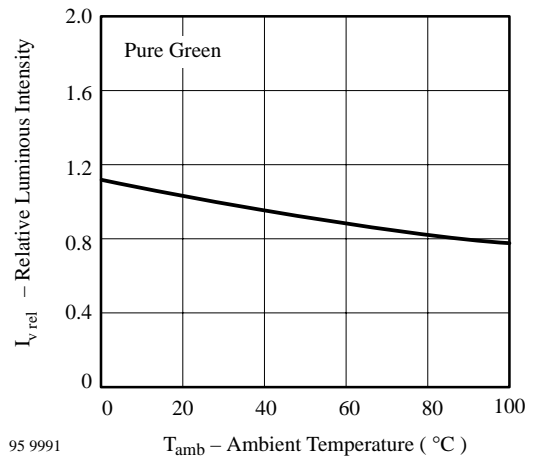

95 9991

Figure 27. Rel. Luminous Intensity vs. Ambient Temperature

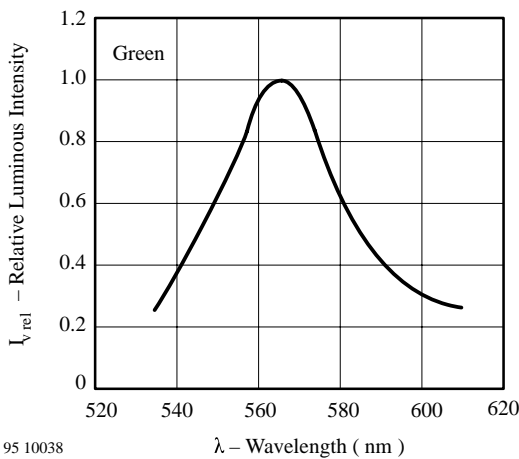

95 10038

Figure 25. Relative Luminous Intensity vs. Wavelength

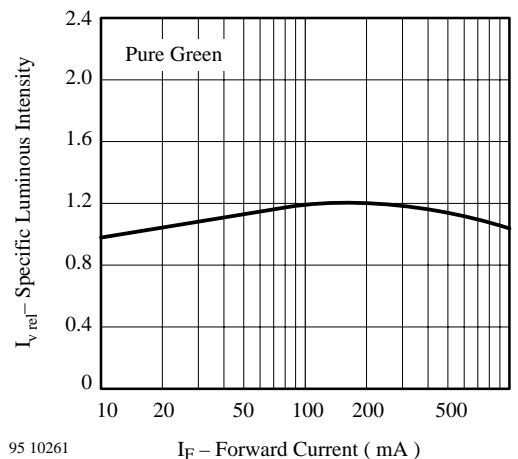

95 10261

Figure 28. Specific Luminous Intensity vs. Forward Current

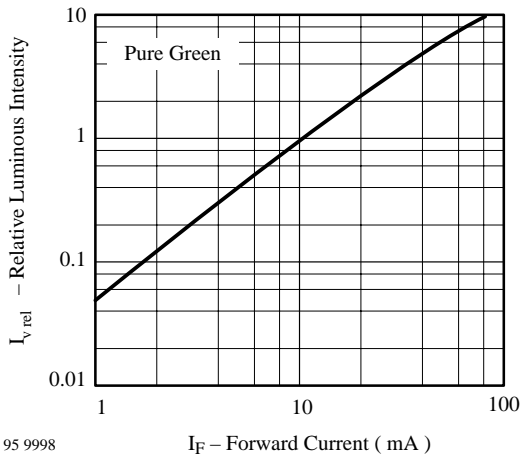
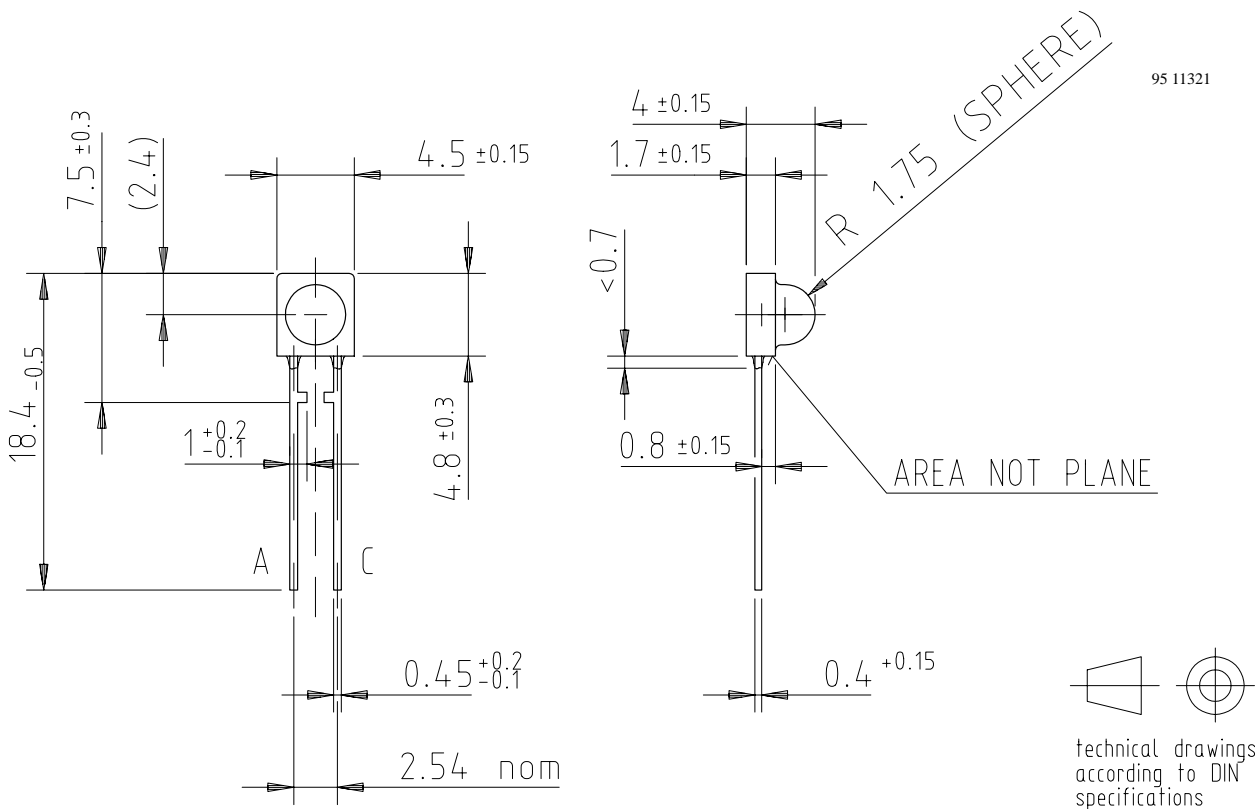

Figure 29. Relative Luminous Intensity vs. Forward Current

Dimensions in mm







## **Ozone Depleting Substances Policy Statement**

It is the policy of **Vishay Semiconductor GmbH** to

1. Meet all present and future national and international statutory requirements.
2. Regularly and continuously improve the performance of our products, processes, distribution and operating systems with respect to their impact on the health and safety of our employees and the public, as well as their impact on the environment.

It is particular concern to control or eliminate releases of those substances into the atmosphere which are known as ozone depleting substances (ODSs).

The Montreal Protocol (1987) and its London Amendments (1990) intend to severely restrict the use of ODSs and forbid their use within the next ten years. Various national and international initiatives are pressing for an earlier ban on these substances.

**Vishay Semiconductor GmbH** has been able to use its policy of continuous improvements to eliminate the use of ODSs listed in the following documents.

1. Annex A, B and list of transitional substances of the Montreal Protocol and the London Amendments respectively
2. Class I and II ozone depleting substances in the Clean Air Act Amendments of 1990 by the Environmental Protection Agency (EPA) in the USA
3. Council Decision 88/540/EEC and 91/690/EEC Annex A, B and C (transitional substances) respectively.

**Vishay Semiconductor GmbH** can certify that our semiconductors are not manufactured with ozone depleting substances and do not contain such substances.

**We reserve the right to make changes to improve technical design and may do so without further notice.**

Parameters can vary in different applications. All operating parameters must be validated for each customer application by the customer. Should the buyer use Vishay-Telefunken products for any unintended or unauthorized application, the buyer shall indemnify Vishay-Telefunken against all claims, costs, damages, and expenses, arising out of, directly or indirectly, any claim of personal damage, injury or death associated with such unintended or unauthorized use.

Vishay Semiconductor GmbH, P.O.B. 3535, D-74025 Heilbronn, Germany  
Telephone: 49 (0)7131 67 2831, Fax number: 49 (0)7131 67 2423