

Model 65

Infrared Thermometer

Calibration Information

Introduction

This calibration information for the Fluke 65 Infrared Thermometer (also referred to as “the UUT”) provides the following information:

- Safety information
- Specifications
- Basic maintenance
- Equipment required for performance tests and calibration
- Performance test procedures
- Calibration adjustment procedures
- List of replaceable parts

For complete operating instructions, refer to the Model 65 Infrared Thermometer Instruction Sheet.

Contacting Fluke

To locate an authorized service center, visit us on the World Wide Web at **www.fluke.com**. Or, call Fluke as follows:

- USA: 1-888-99-FLUKE (1-888-993-5853)
- Canada: 1-800-36-FLUKE (1-800-363-5853)
- Europe: +31 402-678-200
- Japan: +81-3-3434-0181
- Singapore: +65-738-5655
- Anywhere in the world: +1-425-446-5500

Safety Information

Warning

To avoid possible personal injury:



- The information provided in this manual is for the use of qualified personnel only. Do not perform the verification tests or calibration procedures described in this manual unless you are qualified to do so.
- Performance of procedures other than those specified herein may result in hazardous light exposure.
- Do not stare into the laser beam or direct it toward the eyes.

Caution

To avoid possible damage to the thermometer and to ensure correct measurements:

- The Fluke 65 Infrared Thermometer contains parts that can be damaged by static discharge. No procedure in this document requires the case to be opened. If you do so, follow the standard practices for handling static sensitive devices.
- Do not drop the thermometer or subject it to violent shocks.
- Do not operate the thermometer near large electrical or magnetic fields.
- Do not touch the object with the thermometer.
- Keep the thermometer away from direct sunlight or strong sources of light, hot objects (70 °C / 158 °F), high temperatures, high humidity, or dust during use and storage.
- Do not apply sudden temperature changes to the thermometer. Before taking measurements, wait for the thermometer to return to a stable temperature.
- During performance tests and calibration, expose the thermometer to the blackbody heat source only long enough to complete the measurement (< 15 seconds). Between measurements, move the thermometer to an area not affected by the heat source.
- Do not touch the focal lens.
- Condensation may form on the focal lens if the thermometer moves quickly from a cold to a hot environment. Before taking measurements, wait for the condensation to dissipate.

Specifications

Measurement Range	-40 °C to +500 °C (-40 °F to +932 °F)
Operating Temperature (Ambient)	0 °C to +50 °C (+32 °F to +122 °F)
Storage Temperature	-20 °C to +70 °C (-4 °F to +158 °F), without battery
Display Resolution	Below 200 °: 0.1° Above 200 °: 1°
Measurement Accuracy	Below 0 °C: ±5 °C (32 °F: ±9 °F) Above 0 °C: ±2 °C (32 °F: ±4 °F) Above 100 °C: ±2 % of reading [Ambient: 25 °C ±3 °C (77 °F ±5 °F)]
Temperature Coefficient	> 400 °C (752 °F): ±0.06 % reading ≤ 400 °C (752 °F): ±0.24 % reading [Ambient: < 22 °C (72 °F); > 28 °C (82 °F)]
Response Time	0.8 second (for 95 % response)
Spectral Response	8 μm to 14 μm nominal
Field of View/Target Size	8:1; 25 mm (1 in) minimum spot size
Laser beam divergence	< 0.01 radian
Repeatability	±1 % of reading or ±1°, whichever is greater
Emissivity	Fixed at 0.95
Humidity	10 % to 90 % RH non-condensing
Altitude	Storage: 0 km to 12 km (40,000 ft) Operating: 0 km to 3 km (10,000 ft)
Sensor Element	Thermopile
Power Supply	2 AA alkaline batteries, not installed
Battery Life	> 15 hours with laser and backlight activated (> 4000 individual measurements under typical conditions)
Backlight	Auto-on under low-light conditions
Hold	Temperature value is held on the screen for 20 seconds
Dimensions	38.1 mm H × 63.5 mm W × 185.4 mm L (1.5 in H × 2.5 in W × 7.3 in L)
Weight	283.5 g (10 oz)
Safety/Regulatory Compliance	 CE Certification  SP Approval US 21 CFR Subchapter J Part 1040.10 IEC 60825-1 (1998-01) Edition 1.1 EN 60825-1:1994/A11:1996

Maintenance

Installing the Batteries

Remove the holster to access the battery door. Figure 1 shows how to replace the batteries.

Caution

- **Match the + and – polarities of the battery with the battery case.**
- **Do not attempt to recharge the batteries.**
- **Do not throw batteries into a fire.**
- **Follow local laws or regulations when disposing of batteries.**

The  indicates battery life remaining. Replace both batteries when  starts blinking.

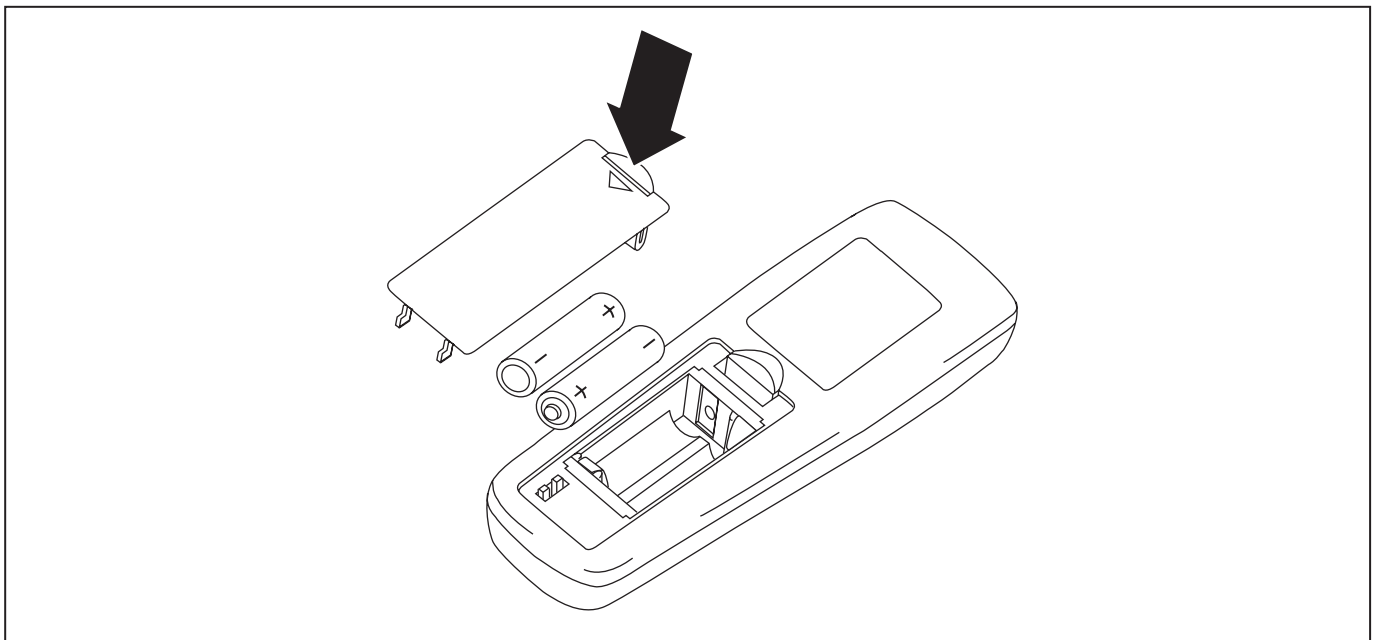

Figure 1. Replacing the Batteries

acd02f.eps

Cleaning the Focal Lens

Do not use solvents to clean the focal lens. Blow off loose particles using clean, dry, compressed air. Gently brush remaining debris away with a camel hair brush or high-quality lens tissue. The tissue may be moistened with clean water.

Cleaning the Case and Holster

Use soap and water or a mild commercial cleaner. Wipe with a damp sponge or soft rag.

Required Equipment

Table 1 shows the equipment required for the performance tests and calibration adjustments.

Table 1. Required Equipment

Equipment	Minimum Specifications	Recommended Model
Blackbody Calibration Source	Temperature range: Ambient to 400 °C Minimum aperture diameter: 76 mm (3.0 in) Maximum temperature: ≥ 400 °C Accuracy: ± 0.5 °C to 100 °C ± 0.5 % of reading above 100 °C	Mikron [®] M315 Blackbody Calibration Source with 0.95 emissivity error correction table

Setting Up for Performance Tests and Calibration

1. Turn on the blackbody. Set it to room temperature and let it stabilize as recommended by the manufacturer.
2. Let the UUT stabilize in the calibration area environment (25 °C ± 3 °C) for a minimum of 20 minutes before proceeding.
3. Verify that the UUT's laser light is activated. When you press \bigcirc , \triangle appears in the display and the laser spot is visible. If not, turn on the laser switch located under the battery hatch.
4. Place the UUT 8" from the front of the blackbody. Center the UUT's thermopile on the blackbody's aperture. Note that the laser is offset from the thermopile.

Performance Tests

Use the following procedure to verify the performance of the UUT. If the UUT fails any of the tests, it needs calibration or repair.

Caution

To avoid inaccurate readings during performance tests, expose the UUT to the blackbody heat source only long enough to complete the measurement (< 15 seconds). Between measurements, move the UUT to an area not affected by the heat source.

1. Set up the UUT and the blackbody as described under "Setting Up for Performance Tests and Calibration".
2. The emissivity of the blackbody will be different than the emissivity of the UUT. Use the emissivity error correction table provided for the blackbody to determine the proper set point for each temperature in the first column of Table 2 at 0.95 emissivity.
3. For each temperature you determined in step 2, do the following:
 - a. Set the blackbody to the temperature. Let the blackbody stabilize.
 - b. Use the UUT to measure the temperature of the blackbody. Verify that the UUT reading is within the limits given.

Table 2. Performance Test Values

Temperature at 0.95 Emissivity	UUT Reading Limits ^{1, 2}
Room temperature	Room temperature ± 2 °C (± 3.6 °F)
200 °C (392 °F)	196 °C to 204 °C (384.8 °F to 399.2 °F)
300 °C (572 °F)	294 °C to 306 °C (561.2 °F to 582.8 °F)
400 °C (752 °F)	392 °C to 408 °C (737.6 °F to 766.4 °F)

1. Room temperature must be 25 °C ± 3 °C (77 °F ± 5 °F).
 2. Limits given are ± 2 % of temperature at 0.95 emissivity.

Calibration Adjustments











The Model 65 Infrared Thermometer should be calibrated and, if necessary, adjusted annually using the following procedure:

Caution

To avoid inaccurate readings during calibration, expose the UUT to the blackbody heat source only long enough to complete the measurement (< 15 seconds). Between measurements, move the UUT to an area not affected by the heat source.

Caution

Do not make any calibration adjustments when UUT is in factory calibration mode (refer to Figure 2). Doing so will cause the UUT to give inaccurate readings, and you will need to return the UUT to a Fluke service center for recalibration.

1. Turn on the UUT.
2. Press and hold  and  until all display segments are lit (about 5 seconds); then also press and hold  and  until the UUT displays $l-l$ (about 5 seconds), as shown in Figure 2. To scroll the calibration menu, press  or .
3. Set up the UUT and the blackbody as described under “Setting Up for Performance Tests and Calibration”.
4. In the room-temperature adjustment mode (display shows $l-l$), press . The default room temperature appears on the UUT display.
5. Verify that the UUT thermopile is centered on the blackbody target; then use  or  to adjust the UUT reading down or up, respectively, to match the room temperature reading at 0.95 emissivity.
6. When you have set the UUT reading to room temperature at 0.95 emissivity, press . The UUT display flashes briefly, then returns to the calibration selection mode.
7. Use the emissivity error correction table to adjust the blackbody for an output of 350 °C at 0.95 emissivity.

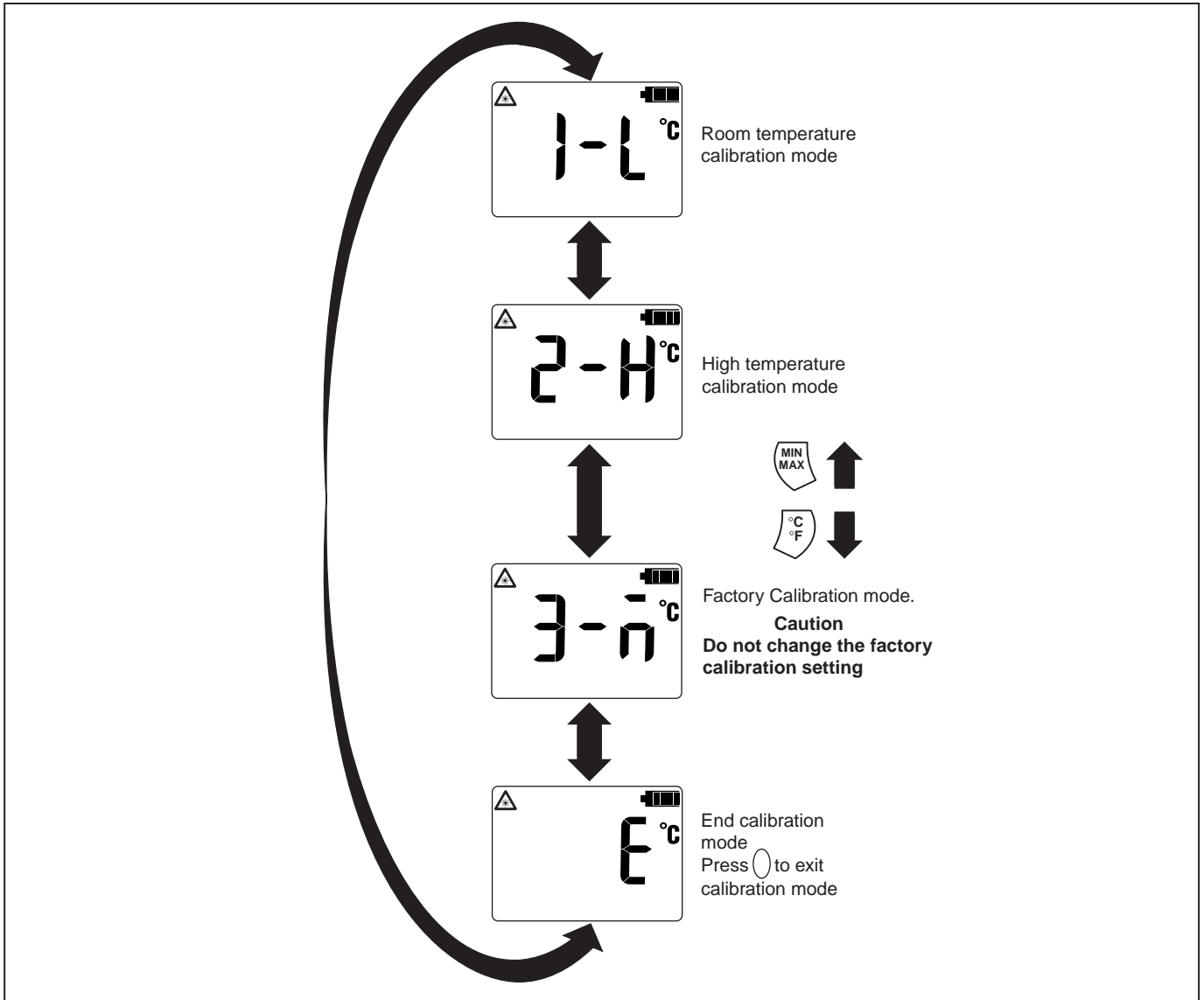

Figure 2. Calibration Menu

acd01f.eps

Model 65

Calibration Information

- Press H to enter the high-temperature adjustment mode (display shows 2-H), as shown in Figure 2.
- Press 0 . The default high-temperature appears on the UUT display.
- Aim the UUT at the blackbody target; then use MIN or MAX to adjust the UUT reading down or up, respectively, to read 350 °C.
- When you have set the UUT reading to 350 °C, press 0 . The UUT display flashes briefly, then returns to the calibration selection mode.

Note

If the high temperature you enter during calibration varies greatly from the measured temperature, the UUT display will flash Err after you press 0. In this case, press 0 again to exit the error mode. Verify that the blackbody is working properly; then try the calibration again.

- Press E to enter the end-of-calibration mode (display shows E), as shown in Figure 2. Press 0 to exit the calibration menu.
- Test the UUT's operation by running the performance tests given earlier under "Performance Tests". If the UUT fails the performance tests, recalibrate the UUT and try the tests again. If the UUT continues to fail, return it to a Fluke Service Center for repair or replacement.

Replacement Parts

Table 3 shows the replacement parts available from Fluke for the Model 65 Infrared Thermometer.

Table 3. Replacement Parts

Description	Fluke Part Number
Top case	803566
Bottom case	803509
Battery door	803517
LCD lens	803558
End cap	803525
Keypad	803541
Softcase	670676
Holster	670612
AA battery, 1.5 V, carbon-zinc (2 required)	650181
AA battery, 1.5 V, alkaline (2 required)	376756
<i>Model 65 Infrared Thermometer Instruction Sheet</i>	
Americas (English, Spanish, French, Portuguese)	801826
European I (English, French, German, Italian, Finnish, Dutch,)	801842
European II (English, Norwegian, Spanish, Portuguese, Swedish, Danish)	801859
Asian (English, Korean, Japanese, Simplified Chinese, Traditional Chinese, Thai)	801834
<i>Model 65 Infrared Thermometer Quick Reference Card (English only)</i>	802261