

BDW84, BDW84A, BDW84B, BDW84C, BDW84D PNP SILICON POWER DARLINGTONS

Copyright © 1997, Power Innovations Limited, UK

AUGUST 1978 - REVISED MARCH 1997

- Designed for Complementary Use with BDW83, BDW83A, BDW83B, BDW83C and BDW83D
- 150 W at 25°C Case Temperature
- 15 A Continuous Collector Current
- Minimum h_{FE} of 750 at 3 V, 6 A

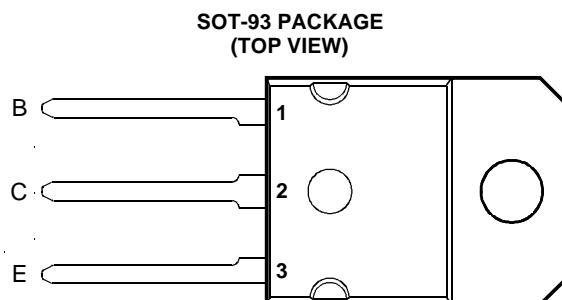

Pin 2 is in electrical contact with the mounting base.

MDTRAA

absolute maximum ratings at 25°C case temperature (unless otherwise noted)

RATING		SYMBOL	VALUE	UNIT
Collector-base voltage ($I_E = 0$)	BDW84	V_{CBO}	-45	V
	BDW84A		-60	
	BDW84B		-80	
	BDW84C		-100	
	BDW84D		-120	
Collector-emitter voltage ($I_B = 0$) (see Note 1)	BDW84	V_{CEO}	-45	V
	BDW84A		-60	
	BDW84B		-80	
	BDW84C		-100	
	BDW84D		-120	
Emitter-base voltage		V_{EBO}	-5	V
Continuous collector current		I_C	-15	A
Continuous base current		I_B	-0.5	A
Continuous device dissipation at (or below) 25°C case temperature (see Note 2)		P_{tot}	150	W
Continuous device dissipation at (or below) 25°C free air temperature (see Note 3)		P_{tot}	3.5	W
Unclamped inductive load energy (see Note 4)		$\frac{1}{2}LI_C^2$	100	mJ
Operating junction temperature range		T_j	-65 to +150	°C
Operating temperature range		T_{stg}	-65 to +150	°C
Operating free-air temperature range		T_A	-65 to +150	°C

- NOTES: 1. These values apply when the base-emitter diode is open circuited.
 2. Derate linearly to 150°C case temperature at the rate of 1.2 W/°C.
 3. Derate linearly to 150°C free air temperature at the rate of 28 mW/°C.
 4. This rating is based on the capability of the transistor to operate safely in a circuit of: $L = 20$ mH, $I_{B(on)} = -5$ mA, $R_{BE} = 100$ Ω , $V_{BE(off)} = 0$, $R_S = 0.1$ Ω , $V_{CC} = -20$ V.

PRODUCT INFORMATION

Information is current as of publication date. Products conform to specifications in accordance with the terms of Power Innovations standard warranty. Production processing does not necessarily include testing of all parameters.

BDW84, BDW84A, BDW84B, BDW84C, BDW84D

PNP SILICON POWER DARLINGTONS

AUGUST 1978 - REVISED MARCH 1997

electrical characteristics at 25°C case temperature (unless otherwise noted)

PARAMETER	TEST CONDITIONS			MIN	TYP	MAX	UNIT
$V_{(BR)CEO}$ Collector-emitter breakdown voltage	$I_C = -30 \text{ mA}$	$I_B = 0$	(see Note 5)	BDW84 BDW84A BDW84B BDW84C BDW84D			V
I_{CEO} Collector-emitter cut-off current	$V_{CE} = -30 \text{ V}$ $V_{CE} = -30 \text{ V}$ $V_{CE} = -40 \text{ V}$ $V_{CE} = -50 \text{ V}$ $V_{CE} = -60 \text{ V}$	$I_B = 0$ $I_B = 0$ $I_B = 0$ $I_B = 0$ $I_B = 0$		BDW84 BDW84A BDW84B BDW84C BDW84D			mA
I_{CBO} Collector cut-off current	$V_{CB} = -45 \text{ V}$ $V_{CB} = -60 \text{ V}$ $V_{CB} = -80 \text{ V}$ $V_{CB} = -100 \text{ V}$ $V_{CB} = -120 \text{ V}$ $V_{CB} = -45 \text{ V}$ $V_{CB} = -60 \text{ V}$ $V_{CB} = -80 \text{ V}$ $V_{CB} = -100 \text{ V}$ $V_{CB} = -120 \text{ V}$	$I_E = 0$ $I_E = 0$ $I_E = 0$ $I_E = 0$ $I_E = 0$ $I_E = 0$ $I_E = 0$ $I_E = 0$ $I_E = 0$ $I_E = 0$	$T_C = 150^\circ\text{C}$ $T_C = 150^\circ\text{C}$ $T_C = 150^\circ\text{C}$ $T_C = 150^\circ\text{C}$ $T_C = 150^\circ\text{C}$	BDW84 BDW84A BDW84B BDW84C BDW84D BDW84 BDW84A BDW84B BDW84C BDW84D			mA
I_{EBO} Emitter cut-off current	$V_{EB} = -5 \text{ V}$	$I_C = 0$					mA
h_{FE} Forward current transfer ratio	$V_{CE} = -3 \text{ V}$ $V_{CE} = -3 \text{ V}$	$I_C = -6 \text{ A}$ $I_C = -15 \text{ A}$	(see Notes 5 and 6)	750 100		20000	
$V_{BE(on)}$ Base-emitter voltage	$V_{CE} = -3 \text{ V}$	$I_C = -6 \text{ A}$	(see Notes 5 and 6)			-2.5	V
$V_{CE(sat)}$ Collector-emitter saturation voltage	$I_B = -12 \text{ mA}$ $I_B = -150 \text{ mA}$	$I_C = -6 \text{ A}$ $I_C = -15 \text{ A}$	(see Notes 5 and 6)			-2.5 -4	V
V_{EC} Parallel diode forward voltage	$I_E = -15 \text{ A}$	$I_B = 0$				-3.5	V

NOTES: 5. These parameters must be measured using pulse techniques, $t_p = 300 \mu\text{s}$, duty cycle $\leq 2\%$.

6. These parameters must be measured using voltage-sensing contacts, separate from the current carrying contacts.

thermal characteristics

PARAMETER	MIN	TYP	MAX	UNIT
$R_{\theta JC}$ Junction to case thermal resistance			0.83	$^\circ\text{C/W}$
$R_{\theta JA}$ Junction to free air thermal resistance			35.7	$^\circ\text{C/W}$

resistive-load-switching characteristics at 25°C case temperature

PARAMETER	TEST CONDITIONS †			MIN	TYP	MAX	UNIT
t_{on} Turn-on time	$I_C = -10 \text{ A}$	$I_{B(on)} = -40 \text{ mA}$	$I_{B(off)} = 40 \text{ mA}$		0.9		μs
t_{off} Turn-off time	$V_{BE(off)} = 4.2 \text{ V}$	$R_L = 3 \Omega$	$t_p = 20 \mu\text{s}$, dc $\leq 2\%$		7		μs

† Voltage and current values shown are nominal; exact values vary slightly with transistor parameters.

TYPICAL CHARACTERISTICS

TYPICAL DC CURRENT GAIN
VS
COLLECTOR CURRENT

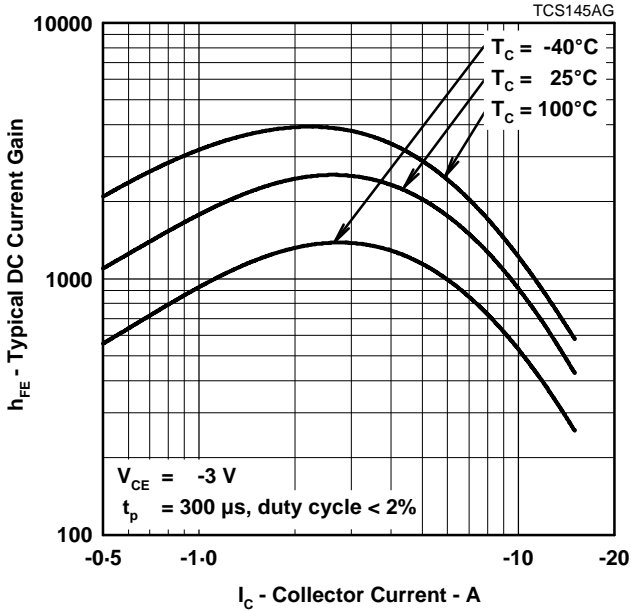

Figure 1.

COLLECTOR-EMITTER SATURATION VOLTAGE
VS
COLLECTOR CURRENT

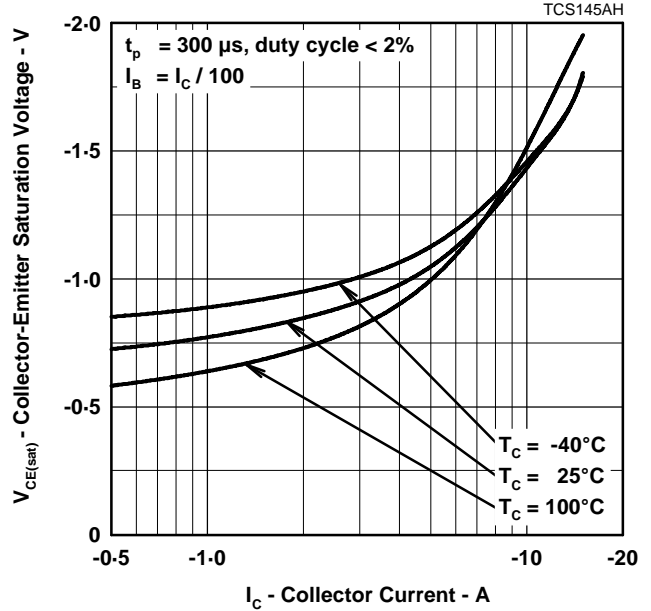

Figure 2.

BASE-EMITTER SATURATION VOLTAGE
VS
COLLECTOR CURRENT

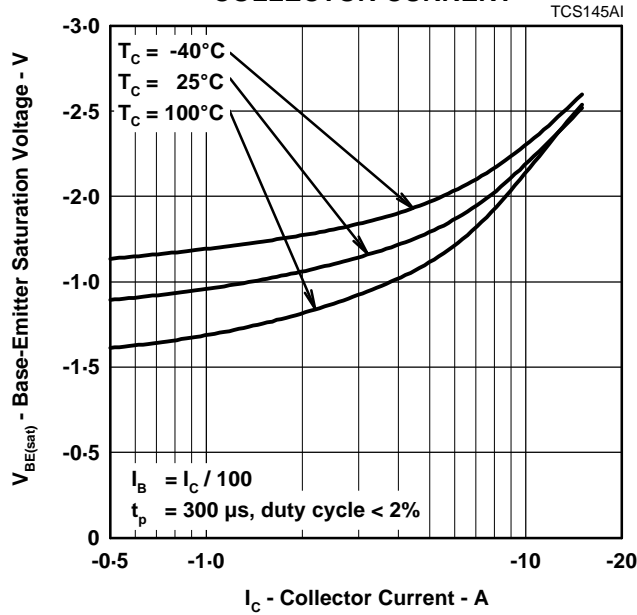

Figure 3.

BDW84, BDW84A, BDW84B, BDW84C, BDW84D PNP SILICON POWER DARLINGTONS

AUGUST 1978 - REVISED MARCH 1997

MAXIMUM SAFE OPERATING REGIONS

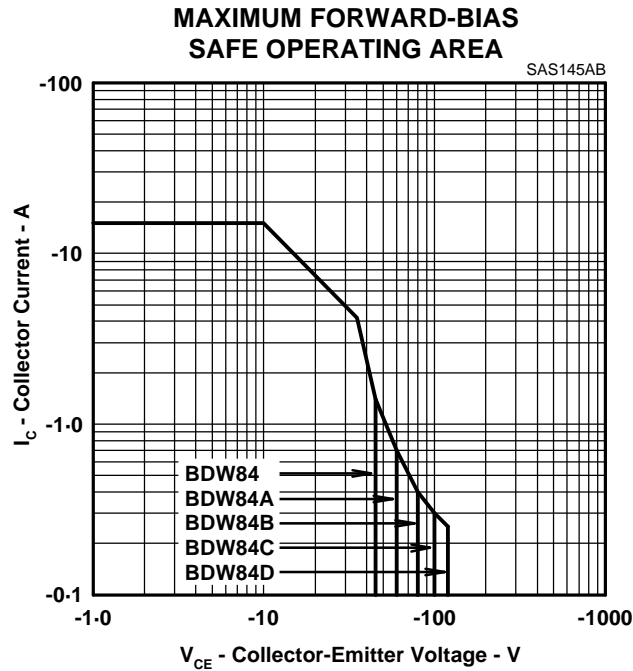

Figure 4.

THERMAL INFORMATION

MAXIMUM POWER DISSIPATION vs CASE TEMPERATURE

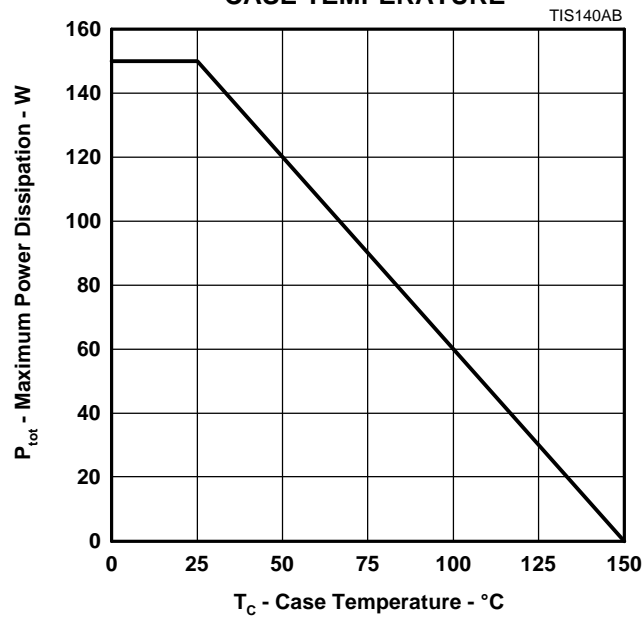

Figure 5.

PRODUCT INFORMATION

BDW84, BDW84A, BDW84B, BDW84C, BDW84D PNP SILICON POWER DARLINGTONS

AUGUST 1978 - REVISED MARCH 1997

MECHANICAL DATA

SOT-93

3-pin plastic flange-mount package

This single-in-line package consists of a circuit mounted on a lead frame and encapsulated within a plastic compound. The compound will withstand soldering temperature with no deformation, and circuit performance characteristics will remain stable when operated in high humidity conditions. Leads require no additional cleaning or processing when used in soldered assembly.

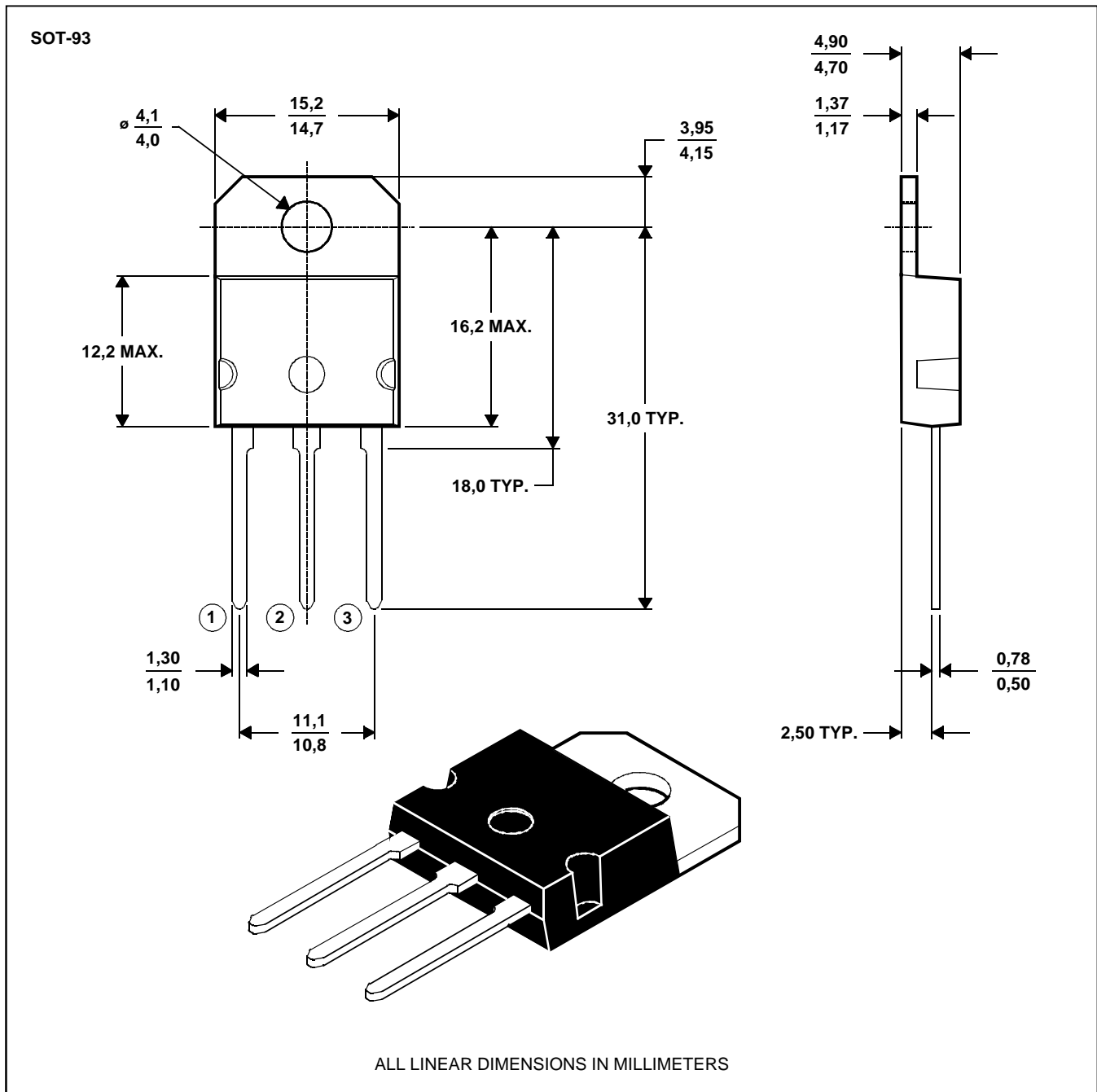

NOTE A: The centre pin is in electrical contact with the mounting tab.

MDXXAW

BDW84, BDW84A, BDW84B, BDW84C, BDW84D

PNP SILICON POWER DARLINGTONS

AUGUST 1978 - REVISED MARCH 1997

IMPORTANT NOTICE

Power Innovations Limited (PI) reserves the right to make changes to its products or to discontinue any semiconductor product or service without notice, and advises its customers to verify, before placing orders, that the information being relied on is current.

PI warrants performance of its semiconductor products to the specifications applicable at the time of sale in accordance with PI's standard warranty. Testing and other quality control techniques are utilized to the extent PI deems necessary to support this warranty. Specific testing of all parameters of each device is not necessarily performed, except as mandated by government requirements.

PI accepts no liability for applications assistance, customer product design, software performance, or infringement of patents or services described herein. Nor is any license, either express or implied, granted under any patent right, copyright, design right, or other intellectual property right of PI covering or relating to any combination, machine, or process in which such semiconductor products or services might be or are used.

PI SEMICONDUCTOR PRODUCTS ARE NOT DESIGNED, INTENDED, AUTHORIZED, OR WARRANTED TO BE SUITABLE FOR USE IN LIFE-SUPPORT APPLICATIONS, DEVICES OR SYSTEMS.

Copyright © 1997, Power Innovations Limited

PRODUCT INFORMATION