



# MC74AC563 MC74ACT563

OCTAL D-TYPE  
LATCH WITH  
3-STATE OUTPUTS

## Octal D-Type Latch with 3-State Outputs

The MC74AC563/74ACT563 is a high-speed octal latch with buffered common Latch Enable (LE) and buffered common Output Enable (OE) inputs.

The MC74AC563/74ACT563 device is functionally identical to the MC74AC573/74ACT573, but with inverted outputs.

- Inputs and Outputs on Opposite Sides of Package Allowing Easy Interface with Microprocessors
- Useful as Input or Output Port for Microprocessors
- Functionally Identical to MC74AC573/74ACT573 but with Inverted Outputs
- Outputs Source/Sink 24 mA
- 'ACT563 Has TTL Compatible Inputs

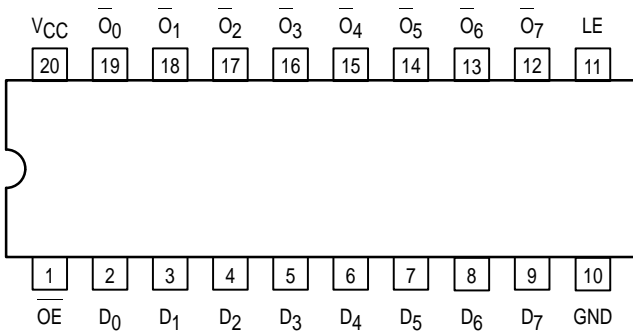
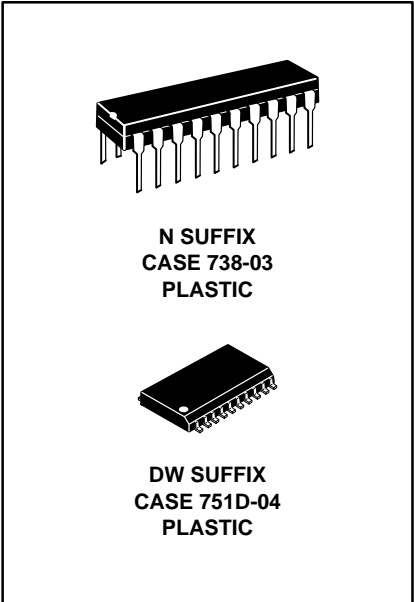

### PIN NAMES

- D<sub>0</sub>-D<sub>7</sub> Data Inputs
- LE Latch Enable Input
- OE 3-State Output Enable Input
- O<sub>0</sub>-O<sub>7</sub> 3-State Latch Outputs

### LOGIC SYMBOL

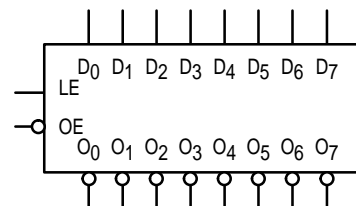

# MC74AC563 MC74ACT563

## FUNCTIONAL DESCRIPTION

The MC74AC563/74ACT563 contains eight D-type latches with 3-state complementary outputs. When the Latch Enable (LE) input is HIGH, data on the  $D_n$  inputs enters the latches. In this condition the latches are transparent, i.e., a latch output will change state each time its D input changes. When LE is LOW the latches store the information that was present on the D inputs a setup time preceding the HIGH-to-LOW transition of  $\overline{LE}$ . The 3-state buffers are controlled by the Output Enable (OE) input. When OE is LOW, the buffers are in the bi-state mode. When OE is HIGH the buffers are in the high impedance mode but that does not interfere with entering new data into the latches.

FUNCTION TABLE

Inputs			Internal	Outputs	Function
OE	LE	D	Q	O	
H	X	X	X	Z	High Z
H	H	L	H	Z	High Z
H	H	H	L	Z	High Z
H	L	X	NC	Z	Latched
L	H	L	H	H	Transparent
L	H	H	L	L	Transparent
L	L	X	NC	NC	Latched

H = HIGH Voltage Level  
 L = LOW Voltage Level  
 X = Immaterial  
 Z = High Impedance  
 NC = No Change

LOGIC DIAGRAM

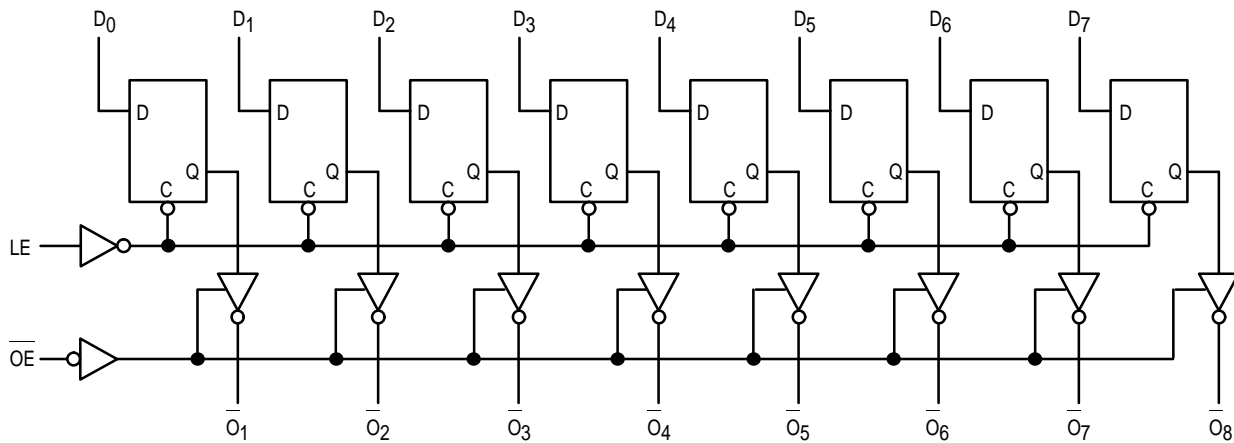

Please note that this diagram is provided only for the understanding of logic operations and should not be used to estimate propagation delays.

# MC74AC563 MC74ACT563

## MAXIMUM RATINGS\*

Symbol	Parameter	Value	Unit
V <sub>CC</sub>	DC Supply Voltage (Referenced to GND)	-0.5 to +7.0	V
V <sub>in</sub>	DC Input Voltage (Referenced to GND)	-0.5 to V <sub>CC</sub> +0.5	V
V <sub>out</sub>	DC Output Voltage (Referenced to GND)	-0.5 to V <sub>CC</sub> +0.5	V
I <sub>in</sub>	DC Input Current, per Pin	±20	mA
I <sub>out</sub>	DC Output Sink/Source Current, per Pin	±50	mA
I <sub>CC</sub>	DC V <sub>CC</sub> or GND Current per Output Pin	±50	mA
T <sub>stg</sub>	Storage Temperature	-65 to +150	°C

\* Maximum Ratings are those values beyond which damage to the device may occur. Functional operation should be restricted to the Recommended Operating Conditions.

## RECOMMENDED OPERATING CONDITIONS

Symbol	Parameter	Min	Typ	Max	Unit	
V <sub>CC</sub>	Supply Voltage	'AC	2.0	5.0	6.0	V
		'ACT	4.5	5.0	5.5	
V <sub>in</sub> , V <sub>out</sub>	DC Input Voltage, Output Voltage (Ref. to GND)	0		V <sub>CC</sub>	V	
t <sub>r</sub> , t <sub>f</sub>	Input Rise and Fall Time (Note 1) 'AC Devices except Schmitt Inputs	V <sub>CC</sub> @ 3.0 V		150		ns/V
		V <sub>CC</sub> @ 4.5 V		40		
		V <sub>CC</sub> @ 5.5 V		25		
t <sub>r</sub> , t <sub>f</sub>	Input Rise and Fall Time (Note 2) 'ACT Devices except Schmitt Inputs	V <sub>CC</sub> @ 4.5 V		10		ns/V
		V <sub>CC</sub> @ 5.5 V		8.0		
T <sub>J</sub>	Junction Temperature (PDIP)			140	°C	
T <sub>A</sub>	Operating Ambient Temperature Range	-40	25	85	°C	
I <sub>OH</sub>	Output Current — High			-24	mA	
I <sub>OL</sub>	Output Current — Low			24	mA	

1. V<sub>in</sub> from 30% to 70% V<sub>CC</sub>; see individual Data Sheets for devices that differ from the typical input rise and fall times.

2. V<sub>in</sub> from 0.8 V to 2.0 V; see individual Data Sheets for devices that differ from the typical input rise and fall times.

# MC74AC563 MC74ACT563

## DC CHARACTERISTICS

Symbol	Parameter	V <sub>CC</sub> (V)	74AC		74AC		Unit	Conditions
			T <sub>A</sub> = +25°C		T <sub>A</sub> = -40°C to +85°C			
			Typ	Guaranteed Limits				
V <sub>IH</sub>	Minimum High Level Input Voltage	3.0	1.5	2.1	2.1	V	V <sub>OUT</sub> = 0.1 V or V <sub>CC</sub> - 0.1 V	
		4.5	2.25	3.15	3.15			
		5.5	2.75	3.85	3.85			
V <sub>IL</sub>	Maximum Low Level Input Voltage	3.0	1.5	0.9	0.9	V	V <sub>OUT</sub> = 0.1 V or V <sub>CC</sub> - 0.1 V	
		4.5	2.25	1.35	1.35			
		5.5	2.75	1.65	1.65			
V <sub>OH</sub>	Minimum High Level Output Voltage	3.0	2.99	2.9	2.9	V	I <sub>OUT</sub> = -50 μA	
		4.5	4.49	4.4	4.4			
		5.5	5.49	5.4	5.4			
		3.0		2.56	2.46	V	*V <sub>IN</sub> = V <sub>IL</sub> or V <sub>IH</sub> -12 mA I <sub>OH</sub> -24 mA -24 mA	
		4.5		3.86	3.76			
		5.5		4.86	4.76			
V <sub>OL</sub>	Maximum Low Level Output Voltage	3.0	0.002	0.1	0.1	V	I <sub>OUT</sub> = 50 μA	
		4.5	0.001	0.1	0.1			
		5.5	0.001	0.1	0.1			
		3.0		0.36	0.44	V	*V <sub>IN</sub> = V <sub>IL</sub> or V <sub>IH</sub> 12 mA I <sub>OL</sub> 24 mA 24 mA	
		4.5		0.36	0.44			
		5.5		0.36	0.44			
I <sub>IN</sub>	Maximum Input Leakage Current	5.5		±0.1	±1.0	μA	V <sub>I</sub> = V <sub>CC</sub> , GND	
I <sub>OZ</sub>	Maximum 3-State Current	5.5		±0.5	±5.0	μA	V <sub>I</sub> (OE) = V <sub>IL</sub> , V <sub>IH</sub> V <sub>I</sub> = V <sub>CC</sub> , GND V <sub>O</sub> = V <sub>CC</sub> , GND	
I <sub>OLD</sub>	†Minimum Dynamic Output Current	5.5			75	mA	V <sub>OLD</sub> = 1.65 V Max	
I <sub>OHD</sub>		5.5			-75	mA	V <sub>OHD</sub> = 3.85 V Min	
I <sub>CC</sub>	Maximum Quiescent Supply Current	5.5		8.0	80	μA	V <sub>IN</sub> = V <sub>CC</sub> or GND	

\* All outputs loaded; thresholds on input associated with output under test.

† Maximum test duration 2.0 ms, one output loaded at a time.

Note: I<sub>IN</sub> and I<sub>CC</sub> @ 3.0 V are guaranteed to be less than or equal to the respective limit @ 5.5 V V<sub>CC</sub>.

# MC74AC563 MC74ACT563

## AC CHARACTERISTICS (For Figures and Waveforms — See Section 3)

Symbol	Parameter	V <sub>CC</sub> * (V)	74AC			74AC		Unit	Fig. No.
			T <sub>A</sub> = +25°C C <sub>L</sub> = 50 pF			T <sub>A</sub> = -40°C to +85°C C <sub>L</sub> = 50 pF			
			Min	Typ	Max	Min	Max		
t <sub>PLH</sub>	Propagation Delay D <sub>n</sub> to O <sub>n</sub>	3.3 5.0	3.5 2.0		13.0 10.0	3.5 2.0	15.0 11.5	ns	3-5
t <sub>PHL</sub>	Propagation Delay D <sub>n</sub> to O <sub>n</sub>	3.3 5.0	3.5 2.0		12.0 9.5	3.5 2.0	14.0 11.0	ns	3-5
t <sub>PLH</sub>	Propagation Delay LE to O <sub>n</sub>	3.3 5.0	3.5 2.0		13.0 9.5	3.5 2.0	15.0 11.0	ns	3-6
t <sub>PHL</sub>	Propagation Delay LE to O <sub>n</sub>	3.3 5.0	3.5 2.0		12.0 8.5	3.5 2.0	14.0 9.5	ns	3-6
t <sub>PZH</sub>	Output Enable Time	3.3 5.0	2.5 2.0		11.0 9.0	2.5 2.0	12.0 10.0	ns	3-7
t <sub>PZL</sub>	Output Enable Time	3.3 5.0	3.0 1.5		11.0 8.5	3.5 2.0	12.5 9.5	ns	3-8
t <sub>PHZ</sub>	Output Disable Time	3.3 5.0	4.0 2.0		12.5 11.0	4.5 2.0	13.5 12.0	ns	3-7
t <sub>PLZ</sub>	Output Disable Time	3.3 5.0	2.0 1.5		9.5 8.0	2.5 1.5	10.5 9.0	ns	3-8

\* Voltage Range 3.3 V is 3.3 V ±0.3 V.  
Voltage Range 5.0 V is 5.0 V ±0.5 V.

## AC OPERATING REQUIREMENTS

Symbol	Parameter	V <sub>CC</sub> * (V)	74AC		74AC		Unit	Fig. No.
			T <sub>A</sub> = +25°C C <sub>L</sub> = 50 pF		T <sub>A</sub> = -40°C to +85°C C <sub>L</sub> = 50 pF			
			Typ	Guaranteed Minimum				
t <sub>s</sub>	Setup Time, HIGH or LOW D <sub>n</sub> to LE	3.3 5.0		2.5 2.0	3.0 2.5		ns	3-9
t <sub>h</sub>	Hold Time, HIGH or LOW D <sub>n</sub> to LE	3.3 5.0		2.0 2.0	2.0 2.0		ns	3-9
t <sub>w</sub>	LE Pulse Width, HIGH	3.3 5.0		6.0 4.0	7.0 5.0		ns	3-6

\* Voltage Range 3.3 V is 3.3 V ±0.3 V.  
Voltage Range 5.0 V is 5.0 V ±0.5 V.

# MC74AC563 MC74ACT563

## DC CHARACTERISTICS

Symbol	Parameter	V <sub>CC</sub> (V)	74ACT		74ACT		Unit	Conditions
			T <sub>A</sub> = +25°C		T <sub>A</sub> = -40°C to +85°C			
			Typ	Guaranteed Limits				
V <sub>IH</sub>	Minimum High Level Input Voltage	4.5	1.5	2.0	2.0	V	V <sub>OUT</sub> = 0.1 V or V <sub>CC</sub> - 0.1 V	
		5.5	1.5	2.0	2.0			
V <sub>IL</sub>	Maximum Low Level Input Voltage	4.5	1.5	0.8	0.8	V	V <sub>OUT</sub> = 0.1 V or V <sub>CC</sub> - 0.1 V	
		5.5	1.5	0.8	0.8			
V <sub>OH</sub>	Minimum High Level Output Voltage	4.5	4.49	4.4	4.4	V	I <sub>OUT</sub> = -50 μA	
		5.5	5.49	5.4	5.4			
		4.5		3.86	3.76	V	*V <sub>IN</sub> = V <sub>IL</sub> or V <sub>IH</sub> -24 mA I <sub>OH</sub> -24 mA	
5.5		4.86	4.76					
V <sub>OL</sub>	Maximum Low Level Output Voltage	4.5	0.001	0.1	0.1	V	I <sub>OUT</sub> = 50 μA	
		5.5	0.001	0.1	0.1			
		4.5		0.36	0.44	V	*V <sub>IN</sub> = V <sub>IL</sub> or V <sub>IH</sub> 24 mA I <sub>OL</sub> 24 mA	
5.5		0.36	0.44					
I <sub>IN</sub>	Maximum Input Leakage Current	5.5		±0.1	±1.0	μA	V <sub>I</sub> = V <sub>CC</sub> , GND	
ΔI <sub>CCT</sub>	Additional Max. I <sub>CC</sub> /Input	5.5	0.6		1.5	mA	V <sub>I</sub> = V <sub>CC</sub> - 2.1 V	
I <sub>OZ</sub>	Maximum 3-State Current	5.5		±0.5	±5.0	μA	V <sub>I</sub> (OE) = V <sub>IL</sub> , V <sub>IH</sub> V <sub>I</sub> = V <sub>CC</sub> , GND V <sub>O</sub> = V <sub>CC</sub> , GND	
I <sub>OLD</sub>	†Minimum Dynamic Output Current	5.5			75	mA	V <sub>OLD</sub> = 1.65 V Max	
I <sub>OHD</sub>		5.5			-75	mA	V <sub>OHD</sub> = 3.85 V Min	
I <sub>CC</sub>	Maximum Quiescent Supply Current	5.5		8.0	80	μA	V <sub>IN</sub> = V <sub>CC</sub> or GND	

\* All outputs loaded; thresholds on input associated with output under test.

† Maximum test duration 2.0 ms, one output loaded at a time.

## AC CHARACTERISTICS (For Figures and Waveforms — See Section 3)

Symbol	Parameter	V <sub>CC</sub> * (V)	74ACT			74ACT		Unit	Fig. No.
			T <sub>A</sub> = +25°C C <sub>L</sub> = 50 pF			T <sub>A</sub> = -40°C to +85°C C <sub>L</sub> = 50 pF			
			Min	Typ	Max	Min	Max		
t <sub>PLH</sub>	Propagation Delay D <sub>n</sub> to O <sub>n</sub>	5.0	3.0		11.5	2.5	12.5	ns	3-5
t <sub>PHL</sub>	Propagation Delay D <sub>n</sub> to O <sub>n</sub>	5.0	3.0		10	2.5	11	ns	3-5
t <sub>PLH</sub>	Propagation Delay LE to O <sub>n</sub>	5.0	3.0		10.5	2.5	11.5	ns	3-6
t <sub>PHL</sub>	Propagation Delay LE to O <sub>n</sub>	5.0	2.5		9.5	2.0	10.5	ns	3-6
t <sub>PZH</sub>	Output Enable Time	5.0	2.5		9.0	2.0	10	ns	3-7
t <sub>PZL</sub>	Output Enable Time	5.0	2.0		8.5	2.0	9.5	ns	3-8
t <sub>PHZ</sub>	Output Disable Time	5.0	3.5		10.5	2.5	11.5	ns	3-7
t <sub>PLZ</sub>	Output Disable Time	5.0	2.0		8.0	1.0	8.5	ns	3-8

\* Voltage Range 5.0 V is 5.0 V ±0.5 V.

# MC74AC563 MC74ACT563

## AC OPERATING REQUIREMENTS

Symbol	Parameter	V <sub>CC</sub> * (V)	74ACT		Unit	Fig. No.
			74ACT			
			Typ	Guaranteed Minimum		
			T <sub>A</sub> = +25°C C <sub>L</sub> = 50 pF		T <sub>A</sub> = -40°C to +85°C C <sub>L</sub> = 50 pF	
t <sub>s</sub>	Setup Time, HIGH or LOW D <sub>n</sub> to LE	5.0		4.0	4.5	ns 3-9
t <sub>h</sub>	Hold Time, HIGH or LOW D <sub>n</sub> to LE	5.0		0	0	ns 3-9
t <sub>w</sub>	LE Pulse Width, HIGH	5.0		3.0	3.0	ns 3-6

\* Voltage Range 5.0 V is 5.0 V ±0.5 V.

## CAPACITANCE

Symbol	Parameter	Value Typ	Unit	Test Conditions
C <sub>IN</sub>	Input Capacitance	4.5	pF	V <sub>CC</sub> = 5.0 V
C <sub>PD</sub>	Power Dissipation Capacitance	50	pF	V <sub>CC</sub> = 5.0 V

# MC74AC563 MC74ACT563

## OUTLINE DIMENSIONS

### N SUFFIX PLASTIC DIP PACKAGE CASE 738-03 ISSUE E

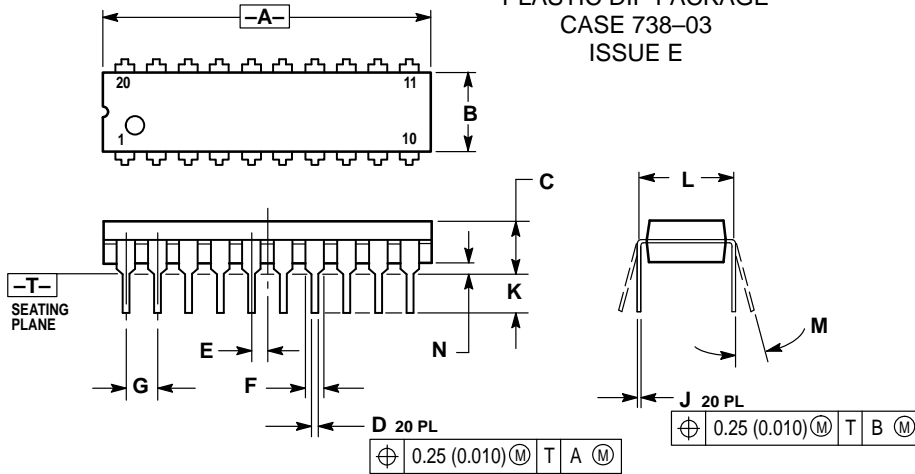

- NOTES:
1. DIMENSIONING AND TOLERANCING PER ANSI Y14.5M, 1982.
  2. CONTROLLING DIMENSION: INCH.
  3. DIMENSION L TO CENTER OF LEAD WHEN FORMED PARALLEL.
  4. DIMENSION B DOES NOT INCLUDE MOLD FLASH.

DIM	INCHES		MILLIMETERS	
	MIN	MAX	MIN	MAX
A	1.010	1.070	25.66	27.17
B	0.240	0.260	6.10	6.60
C	0.150	0.180	3.81	4.57
D	0.015	0.022	0.39	0.55
E	0.050 BSC		1.27 BSC	
F	0.050	0.070	1.27	1.77
G	0.100 BSC		2.54 BSC	
J	0.008	0.015	0.21	0.38
K	0.110	0.140	2.80	3.55
L	0.300 BSC		7.62 BSC	
M	0°	15°	0°	15°
N	0.020	0.040	0.51	1.01

### DW SUFFIX PLASTIC SOIC PACKAGE CASE 751D-04 ISSUE E

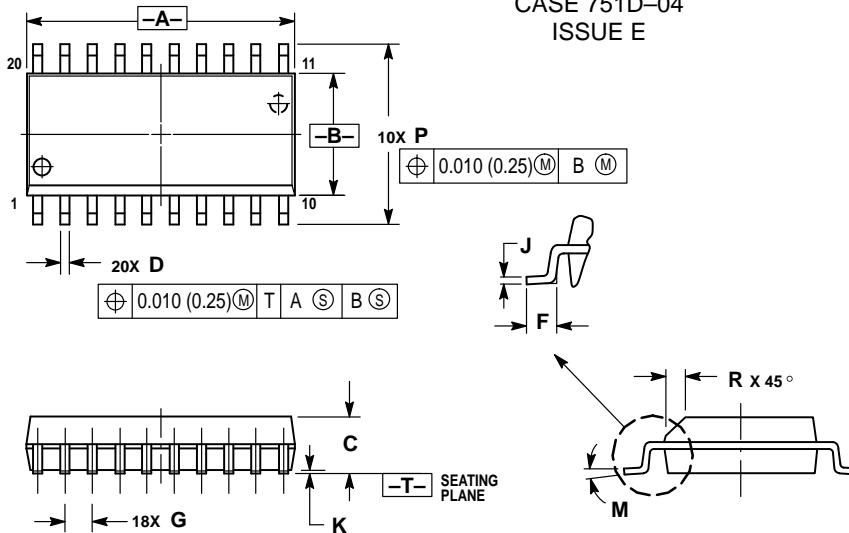

- NOTES:
1. DIMENSIONING AND TOLERANCING PER ANSI Y14.5M, 1982.
  2. CONTROLLING DIMENSION: MILLIMETER.
  3. DIMENSIONS A AND B DO NOT INCLUDE MOLD PROTRUSION.
  4. MAXIMUM MOLD PROTRUSION 0.150 (0.006) PER SIDE.
  5. DIMENSION D DOES NOT INCLUDE DAMBAR PROTRUSION. ALLOWABLE DAMBAR PROTRUSION SHALL BE 0.13 (0.005) TOTAL IN EXCESS OF D DIMENSION AT MAXIMUM MATERIAL CONDITION.

DIM	MILLIMETERS		INCHES	
	MIN	MAX	MIN	MAX
A	12.65	12.95	0.499	0.510
B	7.40	7.60	0.292	0.299
C	2.35	2.65	0.093	0.104
D	0.35	0.49	0.014	0.019
F	0.50	0.90	0.020	0.035
G	1.27 BSC		0.050 BSC	
J	0.25	0.32	0.010	0.012
K	0.10	0.25	0.004	0.009
M	0°	7°	0°	7°
P	10.05	10.55	0.395	0.415
R	0.25	0.75	0.010	0.029

Motorola reserves the right to make changes without further notice to any products herein. Motorola makes no warranty, representation or guarantee regarding the suitability of its products for any particular purpose, nor does Motorola assume any liability arising out of the application or use of any product or circuit, and specifically disclaims any and all liability, including without limitation consequential or incidental damages. "Typical" parameters can and do vary in different applications. All operating parameters, including "Typicals" must be validated for each customer application by customer's technical experts. Motorola does not convey any license under its patent rights nor the rights of others. Motorola products are not designed, intended, or authorized for use as components in systems intended for surgical implant into the body, or other applications intended to support or sustain life, or for any other application in which the failure of the Motorola product could create a situation where personal injury or death may occur. Should Buyer purchase or use Motorola products for any such unintended or unauthorized application, Buyer shall indemnify and hold Motorola and its officers, employees, subsidiaries, affiliates, and distributors harmless against all claims, costs, damages, and expenses, and reasonable attorney fees arising out of, directly or indirectly, any claim of personal injury or death associated with such unintended or unauthorized use, even if such claim alleges that Motorola was negligent regarding the design or manufacture of the part. Motorola and  are registered trademarks of Motorola, Inc. Motorola, Inc. is an Equal Opportunity/Affirmative Action Employer.

#### How to reach us:

USA/EUROPE: Motorola Literature Distribution;  
P.O. Box 20912; Phoenix, Arizona 85036. 1-800-441-2447

JAPAN: Nippon Motorola Ltd.; Tatsumi-SPD-JLDC, Toshikatsu Otsuka,  
6F Seibu-Butsuryu-Center, 3-14-2 Tatsumi Koto-Ku, Tokyo 135, Japan. 03-3521-8315

MFAX: RMFAX0@email.sps.mot.com -TOUCHTONE (602) 244-6609  
INTERNET: <http://Design-NET.com>

HONG KONG: Motorola Semiconductors H.K. Ltd.; 8B Tai Ping Industrial Park,  
51 Ting Kok Road, Tai Po, N.T., Hong Kong. 852-26629298



MC74AC563/D





This datasheet has been download from:

[www.datasheetcatalog.com](http://www.datasheetcatalog.com)

Datasheets for electronics components.