

**CD54/74AC564, CD54/74AC574  
CD54/74ACT564, CD54/74ACT574**

T-46-07-11

Advance Information

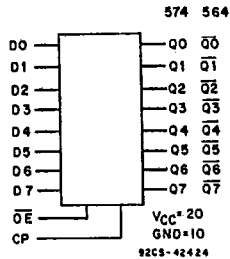

FUNCTIONAL DIAGRAM

**Octal D-Type Flip-Flop, 3-State  
Positive-Edge-Triggered**

CD54/74AC/ACT564 - Inverting  
CD54/74AC/ACT574 - Non-Inverting

Type Features:

- Buffered inputs
- Typical propagation delay:  
6.5 ns @  $V_{CC} = 5V, T_A = 25^\circ C, C_L = 50 pF$

The RCA-CD54/74AC564 and CD54/74AC574 and the CD54/74ACT564 and CD54/74ACT574 octal D-type, 3-state, positive-edge-triggered flip-flops use the RCA ADVANCED CMOS technology. The eight flip-flops enter data into their registers on the LOW-to-HIGH transition of the clock (CP). The Output Enable ( $\overline{OE}$ ) controls the 3-state outputs and is independent of the register operation. When the Output Enable ( $\overline{OE}$ ) is HIGH, the outputs are in the high-impedance state. The CD54/74AC/ACT564 and CD54/74AC/ACT574 share the same pin configurations; the CD54/74AC/ACT564, however, has inverted outputs and the CD54/74AC/ACT574 has non-inverted outputs.

The CD74AC/ACT564 and CD74AC/ACT574 are supplied in 20-lead dual-in-line plastic packages (E suffix) and in 20-lead dual-in-line small-outline plastic packages (M suffix). Both package types are operable over the following temperature ranges: Commercial (0 to 70°C); Industrial (-40 to +85°C); and Extended Industrial/Military (-55 to +125°C).

The CD54AC/ACT564 and CD54AC/ACT574, available in chip form (H suffix), are operable over the -55 to +125°C temperature range.

Family Features:

- Exceeds 2-kV ESD Protection - MIL-STD-883, Method 3015
- SCR-Latchup-resistant CMOS process and circuit design
- Speed of bipolar FAST\*/AS/S with significantly reduced power consumption
- Balanced propagation delays
- AC types feature 1.5-V to 5.5-V operation and balanced noise immunity at 30% of the supply
- $\pm 24$ -mA output drive current
  - Fanout to 15 FAST\* ICs
  - Drives 50-ohm transmission lines

\*FAST is a Registered Trademark of Fairchild Semiconductor Corp.

TRUTH TABLE

INPUTS			OUTPUTS	
			564 $\overline{Qn}$	574 $Qn$
$\overline{OE}$	CP	$Dn$	L	H
L		H	L	H
L		L	H	L
L	L	X	$\overline{Q0}$	Q0
H	X	X	Z	Z

H = High level (steady state)  
L = Low level (steady state)  
X = Don't care  
 = Transition from low to high level  
Q0 = The level of Q before the indicated steady-state input conditions were established  
 $\overline{Q0}$  = The level of  $\overline{Q}$  before the indicated steady-state input conditions were established.  
Z = High impedance

Technical Data

T-46-07-11

**CD54/74AC564, CD54/74AC574**  
**CD54/74ACT564, CD54/74ACT574**

**MAXIMUM RATINGS, Absolute-Maximum Values:**

DC SUPPLY-VOLTAGE ( $V_{CC}$ )	-0.5 to 6 V
DC INPUT DIODE CURRENT, $I_{IK}$ (for $V_i < -0.5$ V or $V_i > V_{CC} + 0.5$ V)	$\pm 20$ mA
DC OUTPUT DIODE CURRENT, $I_{OK}$ (for $V_o < -0.5$ V or $V_o > V_{CC} + 0.5$ V)	$\pm 50$ mA
DC OUTPUT SOURCE OR SINK CURRENT per Output Pin, $I_o$ (for $V_o > -0.5$ V or $V_o < V_{CC} + 0.5$ V)	$\pm 50$ mA
DC $V_{CC}$ or GROUND CURRENT ( $I_{CC}$ or $I_{GND}$ )	$\pm 100$ mA*
POWER DISSIPATION PER PACKAGE ( $P_D$ ):	
For $T_A = -55$ to $+100^\circ\text{C}$ (PACKAGE TYPE E)	500 mW
For $T_A = +100$ to $+125^\circ\text{C}$ (PACKAGE TYPE E)	Derate Linearly at 8 mW/ $^\circ\text{C}$ to 300 mW
For $T_A = -55$ to $+70^\circ\text{C}$ (PACKAGE TYPE M)	400 mW
For $T_A = +70$ to $+125^\circ\text{C}$ (PACKAGE TYPE M)	Derate Linearly at 6 mW/ $^\circ\text{C}$ to 70 mW
OPERATING-TEMPERATURE RANGE ( $T_A$ ):	-55 to $+125^\circ\text{C}$
STORAGE TEMPERATURE ( $T_{STG}$ )	-65 to $+150^\circ\text{C}$
LEAD TEMPERATURE (DURING SOLDERING):	
At distance $1/16 \pm 1/32$ in. ( $1.59 \pm 0.79$ mm) from case for 10 s maximum	$+265^\circ\text{C}$
Unit inserted into PC board min. thickness $1/16$ in. ( $1.59$ mm) with solder contacting lead tips only	$+300^\circ\text{C}$

\*For up to 4 outputs per device; add  $\pm 25$  mA for each additional output.

**RECOMMENDED OPERATING CONDITIONS:**

For maximum reliability, normal operating conditions should be selected so that operation is always within the following ranges:

CHARACTERISTIC	LIMITS		UNITS
	MIN.	MAX.	
Supply-Voltage Range, $V_{CC}$ ; (For $T_A =$ Full Package-Temperature Range) AC Types ACT Types	1.5 4.5	5.5 5.5	V V
DC Input or Output Voltage, $V_i, V_o$	0	$V_{CC}$	V
Operating Temperature, $T_A$ :	-55	+125	$^\circ\text{C}$
Input Rise and Fall Slew Rate, $dt/dv$ at 1.5 V to 3 V (AC Types) at 3.6 V to 5.5 V (AC Types) at 4.5 V to 5.5 V (ACT Types)	0 0 0	50 20 10	ns/V ns/V ns/V

\*Unless otherwise specified, all voltages are referenced to ground.

**TERMINAL ASSIGNMENT DIAGRAMS**

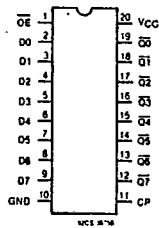

CD54/74AC/ACT564

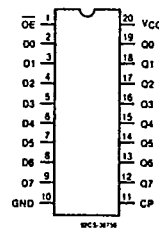

CD54/74AC/ACT574

**CD54/74AC564, CD54/74AC574  
CD54/74ACT564, CD54/74ACT574**

STATIC ELECTRICAL CHARACTERISTICS: AC Series

T-46-07-11

CHARACTERISTICS	TEST CONDITIONS		V <sub>CC</sub> (V)	AMBIENT TEMPERATURE (T <sub>A</sub> ) - °C						UNITS	
				+25		-40 to +85		-55 to +125			
				MIN.	MAX.	MIN.	MAX.	MIN.	MAX.		
High-Level Input Voltage V <sub>IH</sub>			1.5	1.2	—	1.2	—	1.2	—	V	
			3	2.1	—	2.1	—	2.1	—		
			5.5	3.85	—	3.85	—	3.85	—		
Low-Level Input Voltage V <sub>IL</sub>			1.5	—	0.3	—	0.3	—	0.3	V	
			3	—	0.9	—	0.9	—	0.9		
			5.5	—	1.65	—	1.65	—	1.65		
High-Level Output Voltage V <sub>OH</sub>	V <sub>IH</sub> or V <sub>IL</sub>	#, *	-0.05	1.5	1.4	—	1.4	—	1.4	—	V
			-0.05	3	2.9	—	2.9	—	2.9	—	
			-0.05	4.5	4.4	—	4.4	—	4.4	—	
			-4	3	2.58	—	2.48	—	2.4	—	
			-24	4.5	3.94	—	3.8	—	3.7	—	
			-75	5.5	—	—	3.85	—	—	—	
			-50	5.5	—	—	—	—	3.85	—	
Low-Level Output Voltage V <sub>OL</sub>	V <sub>IH</sub> or V <sub>IL</sub>	#, *	0.05	1.5	—	0.1	—	0.1	—	0.1	V
			0.05	3	—	0.1	—	0.1	—	0.1	
			0.05	4.5	—	0.1	—	0.1	—	0.1	
			12	3	—	0.36	—	0.44	—	0.5	
			24	4.5	—	0.36	—	0.44	—	0.5	
			75	5.5	—	—	—	1.65	—	—	
			50	5.5	—	—	—	—	—	1.65	
Input Leakage Current I <sub>I</sub>	V <sub>CC</sub> or GND		5.5	—	±0.1	—	±1	—	±1	μA	
3-State Leakage Current I <sub>OZ</sub>	V <sub>IH</sub> or V <sub>IL</sub> V <sub>O</sub> = V <sub>CC</sub> or GND		5.5	—	±0.5	—	±5	—	±10	μA	
Quiescent Supply Current, MSI I <sub>CC</sub>	V <sub>CC</sub> or GND	0	5.5	—	8	—	80	—	160	μA	

#Test one output at a time for a 1-second maximum duration. Measurement is made by forcing current and measuring voltage to minimize power dissipation.

\*Test verifies a minimum 50-ohm transmission-line-drive capability at +85°C, 75 ohms at +125°C.



Technical Data

T-46-07-11

**CD54/74AC564, CD54/74AC574**  
**CD54/74ACT564, CD54/74ACT574**

STATIC ELECTRICAL CHARACTERISTICS: ACT Series

CHARACTERISTICS	TEST CONDITIONS			AMBIENT TEMPERATURE (T <sub>A</sub> ) - °C						UNITS
	V <sub>I</sub> (V)	I <sub>O</sub> (mA)	V <sub>CC</sub> (V)	+25		-40 to +85		-55 to +125		
				MIN.	MAX.	MIN.	MAX.	MIN.	MAX.	
High-Level Input Voltage V <sub>IH</sub>			4.5 to 5.5	2	—	2	—	2	—	V
Low-Level Input Voltage V <sub>IL</sub>			4.5 to 5.5	—	0.8	—	0.8	—	0.8	V
High-Level Output Voltage V <sub>OH</sub>	V <sub>IH</sub> or V <sub>IL</sub> #, *	-0.05	4.5	4.4	—	4.4	—	4.4	—	V
		-24	4.5	3.94	—	3.8	—	3.7	—	
		-75	5.5	—	—	3.85	—	—	—	
		-50	5.5	—	—	—	—	3.85	—	
Low-Level Output Voltage V <sub>OL</sub>	V <sub>IH</sub> or V <sub>IL</sub> #, *	0.05	4.5	—	±0.1	—	±1	—	±1	V
		24	4.5	—	0.36	—	0.44	—	0.5	
		75	5.5	—	—	—	1.65	—	—	
		50	5.5	—	—	—	—	—	1.65	
Input Leakage Current I <sub>I</sub>	V <sub>CC</sub> or GND		5.5	—	±0.1	—	±1	—	±1	μA
3-State Leakage Current I <sub>OZ</sub>	V <sub>IH</sub> or V <sub>IL</sub> V <sub>O</sub> = V <sub>CC</sub> or GND		5.5	—	±0.5	—	±5	—	±10	μA
Quiescent Supply Current, MSI I <sub>CC</sub>	V <sub>CC</sub> or GND	0	5.5	—	8	—	80	—	160	μA
Additional Quiescent Supply Current per Input Pin TTL Inputs High 1 Unit Load ΔI <sub>CC</sub>	V <sub>CC</sub> -2.1		4.5 to 5.5	—	2.4	—	2.8	—	3	mA

#Test one output at a time for a 1-second maximum duration. Measurement is made by forcing current and measuring voltage to minimize power dissipation.

\*Test verifies a minimum 50-ohm transmission-line-drive capability at +85°C, 75 ohms at +125°C.

ACT INPUT LOADING TABLE

INPUT	UNIT LOADS*
D, OE	0.7
CP	1.17

\*Unit load is ΔI<sub>CC</sub> limit specified in Static Characteristics Chart, e.g., 2.4 mA max. @ 25°C.

**CD54/74AC564, CD54/74AC574  
CD54/74ACT564, CD54/74ACT574**

PREREQUISITE FOR SWITCHING: AC Series

T-46-07-11

CHARACTERISTICS	SYMBOL	V <sub>CC</sub> (V)	AMBIENT TEMPERATURE (T <sub>A</sub> ) -°C				UNITS
			-40 to +85		-55 to +125		
			MIN.	MAX.	MIN.	MAX.	
Clock Pulse Width	t <sub>w</sub>	1.5	44	—	50	—	ns
		3.3*	4.9	—	5.6	—	
		5†	3.5	—	4	—	
Setup Time Data to Clock	t <sub>su</sub>	1.5	2	—	2	—	ns
		3.3	2	—	2	—	
		5	2	—	2	—	
Hold Time Data to Clock	t <sub>h</sub>	1.5	2	—	2	—	ns
		3.3	2	—	2	—	
		5	2	—	2	—	
Maximum Clock Frequency	f <sub>MAX</sub>	1.5	11	—	10	—	MHz
		3.3	101	—	89	—	
		5	143	—	125	—	

\*3.3 V: min. is @ 3 V  
†5 V: min. is @ 4.5 V

SWITCHING CHARACTERISTICS: AC Series; t<sub>r</sub>, t<sub>f</sub> = 3 ns, C<sub>L</sub> = 50 pF

CHARACTERISTICS	SYMBOL	V <sub>CC</sub> (V)	AMBIENT TEMPERATURE (T <sub>A</sub> ) -°C				UNITS
			-40 to +85		-55 to +125		
			MIN.	MAX.	MIN.	MAX.	
Propagation Delays: Clock to Q AC574	t <sub>PLH</sub> t <sub>PHL</sub>	1.5	—	123	—	135	ns
		3.3*	4	13.7	3.8	15.1	
		5†	2.9	9.8	2.7	10.8	
Clock to Q̄ AC564	t <sub>PLH</sub> t <sub>PHL</sub>	1.5	—	128	—	141	ns
		3.3	4.1	14.4	4	15.8	
		5	2.9	10.3	2.8	11.3	
Output Enable to Q, Q̄	t <sub>PZL</sub> t <sub>PZH</sub>	1.5	—	165	—	181	ns
		3.3	5.6	19.2	5.5	21.8	
		5	3.7	13.2	3.6	14.5	
Output Disable to Q, Q̄	t <sub>PLZ</sub> t <sub>PHZ</sub>	1.5	—	165	—	181	ns
		3.3	4.7	16.5	4.5	18.1	
		5	3.7	13.2	3.6	14.5	
Power Dissipation Capacitance	C <sub>PD</sub> §	—	67 Typ.		67 Typ.		pF
Min. (Valley) V <sub>OH</sub> During Switching of Other Outputs (Output Under Test Not Switching)	V <sub>OHV</sub> See Fig. 1	5	4 Typ. @ 25°C				V
Max. (Peak) V <sub>OL</sub> During Switching of Other Outputs (Output Under Test Not Switching)	V <sub>OLP</sub> See Fig. 1	5	1 Typ. @ 25°C				V
Input Capacitance	C <sub>i</sub>	—	—	10	—	10	pF
3-State Output Capacitance	C <sub>o</sub>	—	—	15	—	15	pF



\*3.3 V: min. is @ 3.6 V  
max. is @ 3 V

†5 V: min. is @ 5.5 V  
max. is @ 4.5 V

§C<sub>PD</sub> is used to determine the dynamic power consumption, per flip flop.

$$P_D = C_{PD} V_{CC}^2 f_i + \sum V_{CC}^2 f_o C_L$$

where f<sub>i</sub> = input frequency  
f<sub>o</sub> = output frequency  
C<sub>L</sub> = output load capacitance  
V<sub>CC</sub> = supply voltage.

Technical Data

**CD54/74AC564, CD54/74AC574**  
**CD54/74ACT564, CD54/74ACT574**

T-46-07-11

PREREQUISITE FOR SWITCHING: ACT Series

CHARACTERISTICS	SYMBOL	V <sub>CC</sub> (V)	AMBIENT TEMPERATURE (T <sub>A</sub> ) -°C				UNITS
			-40 to +85		-55 to +125		
			MIN.	MAX.	MIN.	MAX.	
Clock Pulse Width	t <sub>w</sub>	5†	3.9	—	4.5	—	ns
Setup Time Data to Clock	t <sub>su</sub>	5	2	—	2	—	ns
Hold Time Data to Clock	t <sub>h</sub>	5	2.6	—	3	—	ns
Maximum Clock Frequency	f <sub>MAX</sub>	5	125	—	110	—	MHz

†5 V: min. is @ 4.5 V

SWITCHING CHARACTERISTICS: ACT Series; t<sub>r</sub>, t<sub>f</sub> = 3 ns, C<sub>L</sub> = 50 pF

CHARACTERISTICS	SYMBOL	V <sub>CC</sub> (V)	AMBIENT TEMPERATURE (T <sub>A</sub> ) -°C				UNITS
			-40 to +85		-55 to +125		
			MIN.	MAX.	MIN.	MAX.	
Propagation Delays: Clock to Q ACT574	t <sub>PLH</sub> t <sub>PHL</sub>	5†	2.9	10.2	2.8	11.2	ns
Clock to $\bar{Q}$ ACT564	t <sub>PLH</sub> t <sub>PHL</sub>	5	3	10.6	2.9	11.7	ns
Output Enable and Disable to Q ACT574	t <sub>PLZ</sub> t <sub>PHZ</sub> t <sub>PZL</sub> t <sub>PZH</sub>	5	3.7	13.2	3.6	14.5	ns
Output Enable and Disable to $\bar{Q}$ ACT564	t <sub>PLZ</sub> t <sub>PHZ</sub> t <sub>PZL</sub> t <sub>PZH</sub>	5	3.7	13.2	3.6	14.5	ns
Power Dissipation Capacitance	C <sub>PD</sub> §	—	67 Typ.		67 Typ.		pF
Min. (Valley) V <sub>OH</sub> During Switching of Other Outputs (Output Under Test Not Switching)	V <sub>OHV</sub> See Fig. 1	5	4 Typ. @ 25°C				V
Max. (Peak) V <sub>OL</sub> During Switching of Other Outputs (Output Under Test Not Switching)	V <sub>OLP</sub> See Fig. 1	5	1 Typ. @ 25°C				V
Input Capacitance	C <sub>I</sub>	—	—	10	—	10	pF
3-State Output Capacitance	C <sub>O</sub>	—	—	15	—	15	pF

†5 V: min. is @ 5.5 V  
max. is @ 4.5 V§C<sub>PD</sub> is used to determine the dynamic power consumption, per flip flop.
$$P_D = C_{PD} V_{CC}^2 f_i + \sum V_{CC}^2 f_o C_L + V_{CC} \Delta I_{CC}$$

where f<sub>i</sub> = input frequency  
f<sub>o</sub> = output frequency  
C<sub>L</sub> = output load capacitance  
V<sub>CC</sub> = supply voltage.

**CD54/74AC564, CD54/74AC574**  
**CD54/74ACT564, CD54/74ACT574**

T-46-07-11

PARAMETER MEASUREMENT INFORMATION

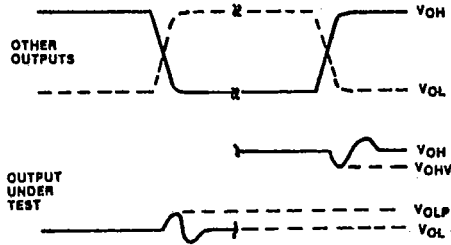

- NOTES:
1. VOHV and VOLP ARE MEASURED WITH RESPECT TO A GROUND REFERENCE NEAR THE OUTPUT UNDER TEST.
  2. INPUT PULSES HAVE THE FOLLOWING CHARACTERISTICS:  
 PRR ≤ 1 MHz,  $t_r = 3$  ns,  $t_f = 3$  ns, SKEW 1 ns.
  3. R.F. FIXTURE WITH 700-MHz DESIGN RULES REQUIRED. IC SHOULD BE SOLDERED INTO TEST BOARD AND BYPASSED WITH 0.1  $\mu$ F CAPACITOR. SCOPE AND PROBES REQUIRE 700-MHz BANDWIDTH.

92CS-42406

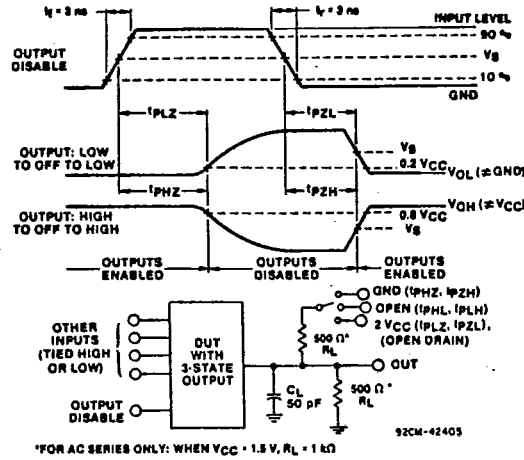

92CM-42405

Fig. 1 - Simultaneous switching transient waveforms.

Fig. 2 - Three-state propagation delay waveforms and test circuit.

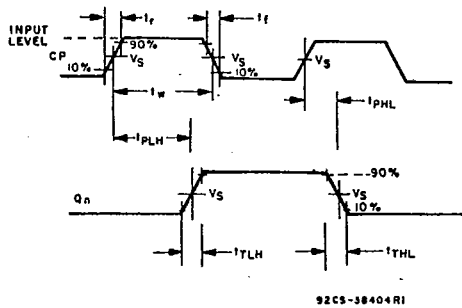

92CS-38404R1

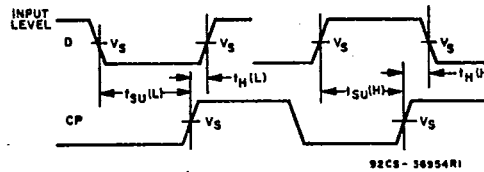

92CS-56954R1

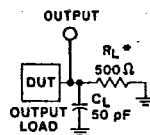

\*FOR AC SERIES ONLY: WHEN  $V_{CC} = 1.5$  V,  $R_L = 1$  k $\Omega$

92CS-42389

	CD54/74AC	CD54/74ACT
Input Level	$V_{CC}$	3 V
Input Switching Voltage, $V_S$	0.5 $V_{CC}$	1.5 V
Output Switching Voltage, $V_S$	0.5 $V_{CC}$	0.5 $V_{CC}$

Fig. 3 - Propagation delays times and test circuit.

Dual-In-Line Plastic Packages

T-90-20

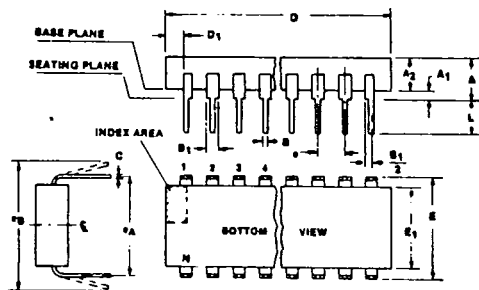

(E) Suffix (JEDEC MS-001-AC)  
14-Lead Dual-In-Line Plastic Package

SYMBOL	INCHES		MILLIMETERS		NOTES
	MIN.	MAX.	MIN.	MAX.	
A	—	0.210	—	5.33	9
A <sub>1</sub>	0.015	—	0.39	—	9
A <sub>2</sub>	0.115	0.195	2.93	4.95	
B	0.014	0.022	0.356	0.558	
B <sub>1</sub>	0.045	0.070	1.15	1.77	3
C	0.008	0.015	0.204	0.381	
D	0.725	0.795	18.42	20.19	4
D <sub>1</sub>	0.005	—	0.13	—	12
E	0.300	0.325	7.62	8.25	5
E <sub>1</sub>	0.240	0.280	6.10	7.11	6, 7
e	0.100 BSC		2.54 BSC		8
*A	0.300 BSC		7.62 BSC		9
*B	—	0.430	—	10.92	10
L	0.115	0.160	2.93	4.06	9
N	14		14		11

92CS-39901

(E) Suffix (JEDEC MS-001-AA)  
16-Lead Dual-In-Line Plastic Package

SYMBOL	INCHES		MILLIMETERS		NOTES
	MIN.	MAX.	MIN.	MAX.	
A	—	0.210	—	5.33	9
A <sub>1</sub>	0.015	—	0.39	—	9
A <sub>2</sub>	0.115	0.195	2.93	4.95	
B	0.014	0.022	0.356	0.558	
B <sub>1</sub>	0.045	0.070	1.15	1.77	3
C	0.008	0.015	0.204	0.381	
D	0.745	0.840	18.93	21.33	4
D <sub>1</sub>	0.005	—	0.13	—	12
E	0.300	0.325	7.62	8.25	5
E <sub>1</sub>	0.240	0.280	6.10	7.11	6, 7
e	0.100 BSC		2.54 BSC		8
*A	0.300 BSC		7.62 BSC		9
*B	—	0.430	—	10.92	10
L	0.115	0.160	2.93	4.06	9
N	16		16		11

92CS-39900

Notes:

1. Refer to JEDEC Publication No. 95 JEDEC Registered and Standard Outlines for Solid State Products, for rules and general information concerning registered and standard outlines, in Section 2.2.
2. Protrusions (flash) on the base plane surface shall not exceed 0.010 in. (0.25 mm).
3. The dimension shown is for full leads. "Half" leads are optional at lead positions  
 $1, N, \frac{N}{2}, \frac{N}{2} + 1.$
4. Dimension D does not include mold flash or protrusions. Mold flash or protrusions shall not exceed 0.010 in. (0.25 mm).
5. E is the dimension to the outside of the leads and is measured with the leads perpendicular to the base plane (zero lead spread).
6. Dimension E<sub>1</sub> does not include mold flash or protrusions.
7. Package body and leads shall be symmetrical around center line shown in end view.
8. Lead spacing e shall be non-cumulative and shall be measured at the lead tip. This measurement shall be made before insertion into gauges, boards or sockets.
9. This is a basic installed dimension. Measurement shall be made with the device installed in the seating plane gauge (JEDEC Outline No. GS-3, seating plane gauge). Leads shall be in true position within 0.010 in. (0.25 mm) diameter for dimension e<sub>A</sub>.
10. e<sub>B</sub> is the dimension to the outside of the leads and is measured at the lead tips before the device is installed. Negative lead spread is not permitted.
11. N is the maximum number of lead positions.
12. Dimension D<sub>1</sub> at the left end of the package must equal dimension D<sub>1</sub> at the right end of the package within 0.030 in. (0.76 mm).
13. For automatic insertion, any raised irregularity on the top surface (step, mesa, etc.) shall be symmetrical about the lateral and longitudinal package centerlines.

(E) Suffix (JEDEC MS-001-AE)  
20-Lead Dual-In-Line Plastic Package

SYMBOL	INCHES		MILLIMETERS		NOTES
	MIN.	MAX.	MIN.	MAX.	
A	—	0.210	—	5.33	9
A <sub>1</sub>	0.015	—	0.39	—	9
A <sub>2</sub>	0.115	0.195	2.93	4.95	
B	0.014	0.022	0.356	0.558	
B <sub>1</sub>	0.045	0.070	1.15	1.77	3
C	0.008	0.015	0.204	0.381	
D	0.925	1.060	23.5	26.9	4
D <sub>1</sub>	0.005	—	0.13	—	12
E	0.300	0.325	7.62	8.25	5
E <sub>1</sub>	0.240	0.280	6.10	7.11	6, 7
e	0.100 BSC		2.54 BSC		8
*A	0.300 BSC		7.62 BSC		9
*B	—	0.430	—	10.92	10
L	0.115	0.160	2.93	4.06	9
N	20		20		11

92CS-39997



# Dual-In-Line Plastic Packages

## T-90-20

(E) Suffix (JEDEC MS-001-AF)  
24-Lead Dual-In-Line Plastic Package

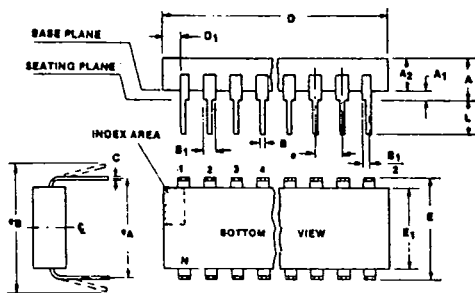

SYMBOL	INCHES		MILLIMETERS		NOTES
	MIN.	MAX.	MIN.	MAX.	
A	—	0.210	—	5.33	9
A <sub>1</sub>	0.015	—	0.39	—	9
A <sub>2</sub>	0.115	0.195	2.93	4.95	
B	0.014	0.022	0.356	0.558	
B <sub>1</sub>	0.045	0.070	1.15	1.77	3
C	0.008	0.015	0.204	0.381	
D	1.125	1.275	28.6	32.3	4
D <sub>1</sub>	0.005	—	0.13	—	12
E	0.300	0.325	7.62	8.25	5
E <sub>1</sub>	0.240	0.280	6.10	7.11	6, 7
e	0.100 BSC		2.54 BSC		8
e <sub>A</sub>	0.300 BSC		7.62 BSC		9
e <sub>B</sub>	—	0.430	—	10.92	10
L	0.115	0.160	2.93	4.06	9
N	24		24		11

92CS-39943

**Notes:**

1. Refer to JEDEC Publication No. 95 JEDEC Registered and Standard Outlines for Solid State Products, for rules and general information concerning registered and standard outlines, in Section 2.2.
2. Protrusions (flash) on the base plane surface shall not exceed 0.010 in. (0.25 mm).
3. The dimension shown is for full leads. "Half" leads are optional at lead positions  

$$1, N, \frac{N}{2}, \frac{N}{2} + 1.$$
4. Dimension D does not include mold flash or protrusions. Mold flash or protrusions shall not exceed 0.010 in. (0.25 mm).
5. E is the dimension to the outside of the leads and is measured with the leads perpendicular to the base plane (zero lead spread).
6. Dimension E<sub>1</sub> does not include mold flash or protrusions.
7. Package body and leads shall be symmetrical around

center line shown in end view.

8. Lead spacing e shall be non-cumulative and shall be measured at the lead tip. This measurement shall be made before insertion into gauges, boards or sockets.
9. This is a basic installed dimension. Measurement shall be made with the device installed in the seating plane gauge (JEDEC Outline No. GS-3, seating plane gauge). Leads shall be in true position within 0.010 in. (0.25 mm) diameter for dimension e<sub>A</sub>.
10. e<sub>B</sub> is the dimension to the outside of the leads and is measured at the lead tips before the device is installed. Negative lead spread is not permitted.
11. N is the maximum number of lead positions.
12. Dimension D<sub>1</sub> at the left end of the package must equal dimension D<sub>1</sub> at the right end of the package within 0.030 in. (0.76 mm).
13. For automatic insertion, any raised irregularity on the top surface (step, mesa, etc.) shall be symmetrical about the lateral and longitudinal package centerlines.



Dimensional Outlines

# Dual-In-Line Small-Outline Plastic Packages

T-90-20

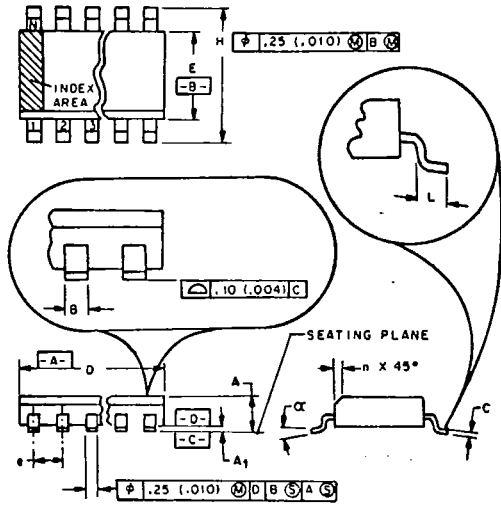

NOTES:

1. Refer to applicable symbol list.
2. Dimensioning and tolerancing per ANSI Y14.5M-1982.
3. "D" is a reference datum.
4. "A" and "B" are reference datums and do not include mold flash or protrusions. Mold flash or protrusions shall not exceed 0.15 mm (0.006 in.).
5. The chamfer on the body is optional. If it is not present, a visual index feature must be located within the cross-hatched area.
6. "L" is the length of terminal for soldering to a substrate.
7. "N" is the number of terminal positions.
8. Terminal numbers are shown for reference only.
9. Controlling dimensions: MILLIMETERS.

M Suffix (JEDEC MS-012AB)  
14-Lead Dual-In-Line Small-Outline (SO) Package

SYMBOL	INCHES		MILLIMETERS		NOTES
	MIN.	MAX.	MIN.	MAX.	
A	0.0532	0.0688	1.35	1.75	
A <sub>1</sub>	0.0040	0.0098	0.10	0.25	
B	0.0138	0.020	0.35	0.508	
C	0.0075	0.0098	0.19	0.25	
D	0.3367	0.3444	8.55	8.75	4
E	0.1497	0.1574	3.80	4.00	4
e	0.050 BSC		1.27 BSC		
H	0.2284	0.2440	5.80	6.20	
h	0.0099	0.0196	0.25	0.50	5
L	0.016	0.050	0.40	1.27	6
N	14		14		7
α	0° 8°		0° 8°		

Notes: 1, 2, 3, 8, 9

92CS-38924R2

M Suffix (JEDEC MS-012AC)  
16-Lead Dual-In-Line Small-Outline (SO) Package

SYMBOL	INCHES		MILLIMETERS		NOTES
	MIN.	MAX.	MIN.	MAX.	
A	0.0532	0.0688	1.35	1.75	
A <sub>1</sub>	0.0040	0.0098	0.10	0.25	
B	0.0138	0.020	0.35	0.508	
C	0.0075	0.0098	0.19	0.25	
D	0.3859	0.3937	9.80	10.00	4
E	0.1497	0.1574	3.80	4.00	4
e	0.050 BSC		1.27 BSC		
H	0.2284	0.2440	5.80	6.20	
h	0.0099	0.0196	0.25	0.50	5
L	0.016	0.050	0.40	1.27	6
N	16		16		7
α	0° 8°		0° 8°		

Notes: 1, 2, 3, 8, 9

92CS-38925R2

M Suffix (JEDEC MS-013AC)  
20-Lead Dual-In-Line Small-Outline (SO) Package

SYMBOL	INCHES		MILLIMETERS		NOTES
	MIN.	MAX.	MIN.	MAX.	
A	0.0926	0.1043	2.35	2.65	
A <sub>1</sub>	0.0040	0.0118	0.10	0.30	
B	0.0138	0.020	0.35	0.508	
C	0.0091	0.0125	0.23	0.32	
D	0.4861	0.5118	12.60	13.00	4
E	0.2914	0.2992	7.40	7.60	4
e	0.050 BSC		1.27 BSC		
H	0.394	0.419	10.00	10.65	
h	0.010	0.029	0.25	0.75	5
L	0.016	0.050	0.40	1.27	6
N	20		20		7
α	0° 8°		0° 8°		

Notes: 1, 2, 3, 8, 9

92CS-38926R2

M Suffix (JEDEC MS-013AD)  
24-Lead Dual-In-Line Small-Outline (SO) Package

SYMBOL	INCHES		MILLIMETERS		NOTES
	MIN.	MAX.	MIN.	MAX.	
A	0.0926	0.1043	2.35	2.65	
A <sub>1</sub>	0.0040	0.0118	0.10	0.30	
B	0.0138	0.020	0.35	0.508	
C	0.0091	0.0125	0.23	0.32	
D	0.5985	0.6141	15.20	15.60	4
E	0.2914	0.2992	7.40	7.60	4
e	0.050 BSC		1.27 BSC		
H	0.394	0.419	10.00	10.65	
h	0.010	0.029	0.25	0.75	5
L	0.016	0.050	0.40	1.27	6
N	24		24		7
α	0° 8°		0° 8°		

Notes: 1, 2, 3, 8, 9

92CS-39037R2