

8-Bit Serial-In/Parallel-Out Shift Register

Features

- Buffered Inputs
- Typical Propagation Delay
 - 6ns at $V_{CC} = 5V$, $T_A = 25^{\circ}C$, $C_L = 50pF$
- Exceeds 2kV ESD Protection MIL-STD-883, Method 3015
- SCR-Latchup-Resistant CMOS Process and Circuit Design
- Speed of Bipolar FAST™/AS/S with Significantly Reduced Power Consumption
- Balanced Propagation Delays
- AC Types Feature 1.5V to 5.5V Operation and Balanced Noise Immunity at 30% of the Supply
- $\pm 24mA$ Output Drive Current
 - Fanout to 15 FAST™ ICs
 - Drives 50 Ω Transmission Lines

Description

The 'AC164 and 'ACT164 are 8-bit serial-in/parallel-out shift registers with asynchronous reset that utilize Advanced CMOS Logic technology. Data is shifted on the positive edge of the clock (CP). A LOW on the Master Reset (\overline{MR}) pin resets the shift register and all outputs go to the LOW state regardless of the input conditions. Two Serial Data inputs (DS1 and DS2) are provided; either one can be used as a Data Enable control.

Ordering Information

PART NUMBER	TEMP. RANGE ($^{\circ}C$)	PACKAGE
CD54AC164F3A	-55 to 125	14 Ld CERDIP
CD74AC164E	-55 to 125	14 Ld PDIP
CD74AC164M	-55 to 125	14 Ld SOIC
CD54ACT164F3A	-55 to 125	14 Ld CERDIP
CD74ACT164E	-55 to 125	14 Ld PDIP
CD74ACT164M	-55 to 125	14 Ld SOIC

NOTES:

1. When ordering, use the entire part number. Add the suffix 96 to obtain the variant in the tape and reel.
2. Wafer and die for this part number is available which meets all electrical specifications. Please contact your local TI sales office or customer service for ordering information.

Pinout

CD54AC164, CD54ACT164
(CERDIP)
CD74AC164, CD74ACT164
(PDIP, SOIC)
TOP VIEW

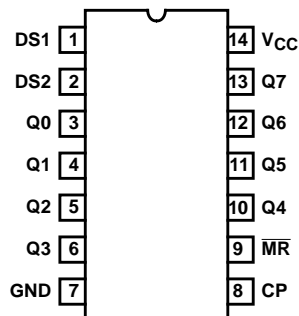

CD54/74AC164, CD54/74ACT164

Functional Diagram

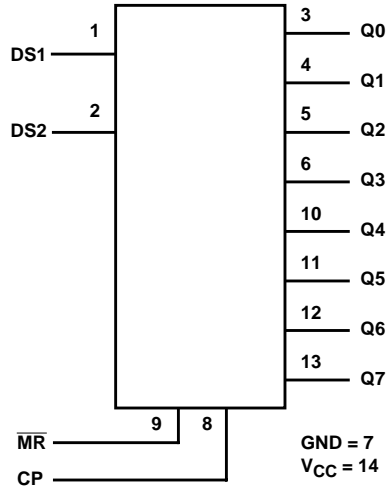

MODE SELECT - TRUTH TABLE

OPERATING MODE	INPUTS				OUTPUTS	
	MR	CP	DS1	DS2	Q0	Q1 - Q7
RESET (CLEAR)	L	X	X	X	L	L - L
SHIFT	H	↑	l	l	L	q0 - q6
	H	↑	l	h	L	q0 - q6
	H	↑	h	l	L	q0 - q6
	H	↑	h	h	H	q0 - q6

H = HIGH voltage level steady state.

L = LOW voltage level steady state.

h = HIGH voltage level one setup time prior to the LOW-to_HIGH clock transition.

l = LOW voltage level one setup time prior to the LOW-to-HIGH clock transition.

X = Don't care.

q = Lowercase letters indicate the state of the referenced output prior to the LOW-to-HIGH clock transition.

↑ = LOW-to-HIGH clock transition.

CD54/74AC164, CD54/74ACT164

Absolute Maximum Ratings

DC Supply Voltage, V_{CC}	-0.5V to 6V
DC Input Diode Current, I_{IK}	
For $V_I < -0.5V$ or $V_I > V_{CC} + 0.5V$	$\pm 20mA$
DC Output Diode Current, I_{OK}	
For $V_O < -0.5V$ or $V_O > V_{CC} + 0.5V$	$\pm 50mA$
DC Output Source or Sink Current per Output Pin, I_O	
For $V_O > -0.5V$ or $V_O < V_{CC} + 0.5V$	$\pm 50mA$
DC V_{CC} or Ground Current, I_{CC} or I_{GND} (Note 3)	$\pm 100mA$

Thermal Information

Thermal Resistance (Typical, Note 5)	θ_{JA} ($^{\circ}C/W$)
PDIP Package	90
SOIC Package	175
Maximum Junction Temperature (Plastic Package)	$150^{\circ}C$
Maximum Storage Temperature Range	$-65^{\circ}C$ to $150^{\circ}C$
Maximum Lead Temperature (Soldering 10s)	$300^{\circ}C$ (SOIC - Lead Tips Only)

Operating Conditions

Temperature Range, T_A	$-55^{\circ}C$ to $125^{\circ}C$
Supply Voltage Range, V_{CC} (Note 4)	
AC Types	1.5V to 5.5V
ACT Types	4.5V to 5.5V
DC Input or Output Voltage, V_I, V_O	0V to V_{CC}
Input Rise and Fall Slew Rate, dt/dv	
AC Types, 1.5V to 3V	50ns (Max)
AC Types, 3.6V to 5.5V	20ns (Max)
ACT Types, 4.5V to 5.5V	10ns (Max)

CAUTION: Stresses above those listed in "Absolute Maximum Ratings" may cause permanent damage to the device. This is a stress only rating and operation of the device at these or any other conditions above those indicated in the operational sections of this specification is not implied.

NOTES:

3. For up to 4 outputs per device, add $\pm 25mA$ for each additional output.
4. Unless otherwise specified, all voltages are referenced to ground.
5. θ_{JA} is measured with the component mounted on an evaluation PC board in free air.

DC Electrical Specifications

PARAMETER	SYMBOL	TEST CONDITIONS		V_{CC} (V)	25 $^{\circ}C$		-40 $^{\circ}C$ TO 85 $^{\circ}C$		-55 $^{\circ}C$ TO 125 $^{\circ}C$		UNITS	
		V_I (V)	I_O (mA)		MIN	MAX	MIN	MAX	MIN	MAX		
AC TYPES												
High Level Input Voltage	V_{IH}	-	-	1.5	1.2	-	1.2	-	1.2	-	V	
				3	2.1	-	2.1	-	2.1	-	V	
				5.5	3.85	-	3.85	-	3.85	-	V	
Low Level Input Voltage	V_{IL}	-	-	1.5	-	0.3	-	0.3	-	0.3	V	
				3	-	0.9	-	0.9	-	0.9	V	
				5.5	-	1.65	-	1.65	-	1.65	V	
High Level Output Voltage	V_{OH}	V_{IH} or V_{IL}	-0.05	-0.05	1.5	1.4	-	1.4	-	1.4	-	V
			-0.05	-0.05	3	2.9	-	2.9	-	2.9	-	V
			-0.05	-0.05	4.5	4.4	-	4.4	-	4.4	-	V
			-4	-4	3	2.58	-	2.48	-	2.4	-	V
			-24	-24	4.5	3.94	-	3.8	-	3.7	-	V
			-75 (Note 6, 7)	-75	5.5	-	-	3.85	-	-	-	V
			-50 (Note 6, 7)	-50	5.5	-	-	-	-	3.85	-	V

CD54/74AC164, CD54/74ACT164

DC Electrical Specifications (Continued)

PARAMETER	SYMBOL	TEST CONDITIONS		V _{CC} (V)	25°C		-40°C TO 85°C		-55°C TO 125°C		UNITS		
		V _I (V)	I _O (mA)		MIN	MAX	MIN	MAX	MIN	MAX			
Low Level Output Voltage	V _{OL}	V _{IH} or V _{IL}	0.05	1.5	-	0.1	-	0.1	-	0.1	V		
			0.05	3	-	0.1	-	0.1	-	0.1	V		
			0.05	4.5	-	0.1	-	0.1	-	0.1	V		
			12	3	-	0.36	-	0.44	-	0.5	V		
			24	4.5	-	0.36	-	0.44	-	0.5	V		
			75 (Note 6, 7)	5.5	-	-	-	1.65	-	-	V		
			50 (Note 6, 7)	5.5	-	-	-	-	-	1.65	V		
Input Leakage Current	I _I	V _{CC} or GND	-	5.5	-	±0.1	-	±1	-	±1	µA		
Quiescent Supply Current MSI	I _{CC}	V _{CC} or GND	0	5.5	-	8	-	80	-	160	µA		
ACT TYPES													
High Level Input Voltage	V _{IH}	-	-	4.5 to 5.5	2	-	2	-	2	-	V		
Low Level Input Voltage	V _{IL}	-	-	4.5 to 5.5	-	0.8	-	0.8	-	0.8	V		
High Level Output Voltage	V _{OH}	V _{IH} or V _{IL}	-0.05	4.5	4.4	-	4.4	-	4.4	-	4.4	V	
			-24	4.5	3.94	-	3.8	-	3.7	-	3.7	V	
			-75 (Note 6, 7)	5.5	-	-	3.85	-	-	-	-	-	V
			-50 (Note 6, 7)	5.5	-	-	-	-	-	3.85	-	3.85	V
Low Level Output Voltage	V _{OL}	V _{IH} or V _{IL}	0.05	4.5	-	0.1	-	0.1	-	0.1	V		
			24	4.5	-	0.36	-	0.44	-	0.5	V		
			75 (Note 6, 7)	5.5	-	-	-	1.65	-	-	V		
			50 (Note 6, 7)	5.5	-	-	-	-	-	1.65	V		
Input Leakage Current	I _I	V _{CC} or GND	-	5.5	-	±0.1	-	±1	-	±1	µA		
Quiescent Supply Current MSI	I _{CC}	V _{CC} or GND	0	5.5	-	8	-	80	-	160	µA		
Additional Supply Current per Input Pin TTL Inputs High 1 Unit Load	ΔI _{CC}	V _{CC} -2.1	-	4.5 to 5.5	-	2.4	-	2.8	-	3	mA		

NOTES:

- Test one output at a time for a 1-second maximum duration. Measurement is made by forcing current and measuring voltage to minimize power dissipation.
- Test verifies a minimum 50Ω transmission-line-drive capability at 85°C, 75Ω at 125°C.

ACT Input Load Table

INPUT	UNIT LOAD
DS1, DS2	0.5
MR	0.74
CP	0.71

NOTE: Unit load is ΔI_{CC} limit specified in DC Electrical Specifications Table, e.g., 2.4mA max at 25°C.

CD54/74AC164, CD54/74ACT164

Prerequisite For Switching Function

PARAMETER	SYMBOL	V _{CC} (V)	-40°C TO 85°C		-55°C TO 125°C		UNITS
			MIN	MAX	MIN	MAX	
AC TYPES							
Max. Clock Frequency	f _{MAX}	1.5	7	-	6	-	MHz
		3.3 (Note 9)	62	-	54	-	MHz
		5 (Note 10)	86	-	75	-	MHz
MR Pulse Width	t _W	1.5	49	-	56	-	ns
		3.3	5.5	-	6.3	-	ns
		5	3.9	-	4.5	-	ns
CP Pulse Width	t _W	1.5	73	-	84	-	ns
		3.3	8.2	-	9.4	-	ns
		5	5.9	-	6.7	-	ns
Set-up Time	t _{SU}	1.5	27	-	31	-	ns
		3.3	3.1	-	3.5	-	ns
		5	2.2	-	2.5	-	ns
Hold Time	t _H	1.5	27	-	31	-	ns
		3.3	3.1	-	3.5	-	ns
		5	2.2	-	2.5	-	ns
MR to CP Removal Time	t _{REM}	1.5	1	-	1	-	ns
		3.3	1	-	1	-	ns
		5	1	-	1	-	ns
ACT TYPES							
Max. Clock Frequency	f _{MAX}	5 (Note 10)	80	-	70	-	MHz
MR Pulse Width	t _W	5	3.9	-	4.5	-	ns
CP Pulse Width	t _W	5	6.2	-	7.1	-	ns
Set-up Time	t _{SU}	5	2.2	-	2.5	-	ns
Hold Time	t _H	5	2.6	-	3	-	ns
MR to CP Removal Time	t _{REM}	5	0	-	0	-	ns

Switching Specifications Input t_r, t_f = 3ns, C_L = 50pF (Worst Case)

PARAMETER	SYMBOL	V _{CC} (V)	-40°C TO 85°C			-55°C TO 125°C			UNITS
			MIN	TYP	MAX	MIN	TYP	MAX	
AC TYPES									
Propagation Delay, CP to Qn	t _{PLH} , t _{PHL}	1.5	-	-	143	-	-	157	ns
		3.3 (Note 9)	4.5	-	15.9	4.4	-	17.5	ns
		5 (Note 10)	3.2	-	11.4	3.1	-	12.5	ns

CD54/74AC164, CD54/74ACT164

Switching Specifications Input t_r , $t_f = 3\text{ns}$, $C_L = 50\text{pF}$ (Worst Case) (Continued)

PARAMETER	SYMBOL	V_{CC} (V)	-40°C TO 85°C			-55°C TO 125°C			UNITS
			MIN	TYP	MAX	MIN	TYP	MAX	
Propagation Delay, $\overline{\text{MR}}$ to Q_n	t_{PLH} , t_{PHL}	1.5	-	-	158	-	-	174	ns
		3.3	5	-	17.7	4.9	-	19.5	ns
		5	3.6	-	12.6	3.5	-	13.9	ns
Input Capacitance	C_I	-	-	-	10	-	-	10	pF
Power Dissipation Capacitance	C_{PD} (Note 11)	-	-	150	-	-	150	-	pF
ACT TYPES									
Propagation Delay, CP to Q_n	t_{PLH} , t_{PHL}	5 (Note 10)	3.8	-	13.5	3.7	-	14.9	ns
Propagation Delay, $\overline{\text{MR}}$ to Q_n	t_{PLH} , t_{PHL}	5	4.1	-	14.4	4	-	15.8	ns
Input Capacitance	C_I	-	-	-	10	-	-	10	pF
Power Dissipation Capacitance	C_{PD} (Note 11)	-	-	150	-	-	150	-	pF

NOTES:

8. Limits tested at 100%.
9. 3.3V Min at 3.6V, Max at 3V.
10. 5V Min at 5.5V, Max at 4.5V.
11. C_{PD} is used to determine the dynamic power consumption per device.
 $P_D = C_{PD}V_{CC}^2 f_i \Sigma (C_L V_{CC}^2 f_o) + V_{CC} \Delta I_{CC}$, where f_i = input frequency, f_o = output frequency, C_L = output load capacitance, V_{CC} = supply voltage.

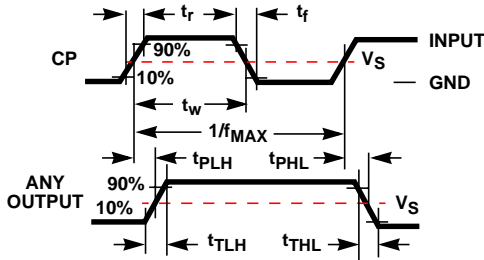

FIGURE 1.

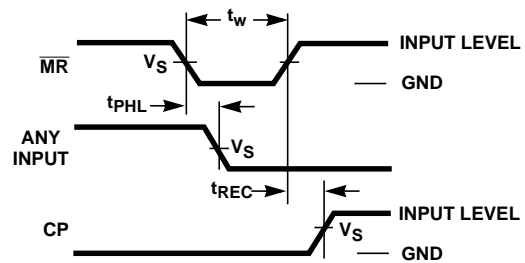

FIGURE 2.

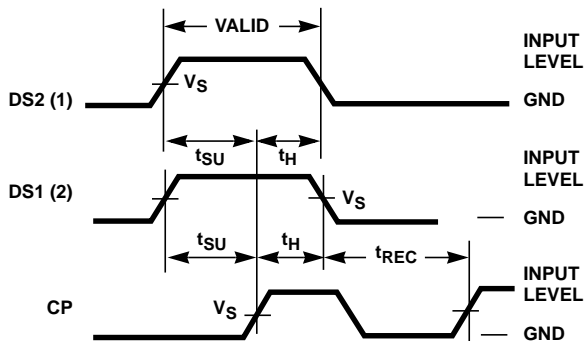

FIGURE 3.

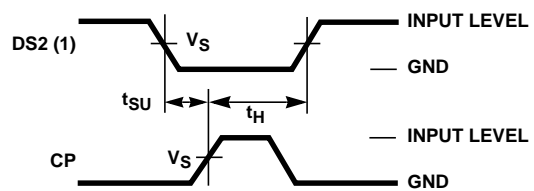
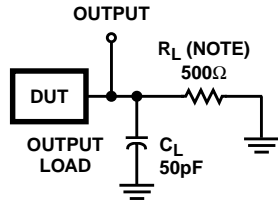

FIGURE 4.

CD54/74AC164, CD54/74ACT164



NOTE: For AC Series Only: When $V_{CC} = 1.5V$, $R_L = 1k\Omega$.

	AC	ACT
Input Level	V_{CC}	3V
Input Switching Voltage, V_S	$0.5 V_{CC}$	1.5V
Output Switching Voltage, V_S	$0.5 V_{CC}$	$0.5 V_{CC}$

FIGURE 5. PROPAGATION DELAY TIMES

IMPORTANT NOTICE

Texas Instruments and its subsidiaries (TI) reserve the right to make changes to their products or to discontinue any product or service without notice, and advise customers to obtain the latest version of relevant information to verify, before placing orders, that information being relied on is current and complete. All products are sold subject to the terms and conditions of sale supplied at the time of order acknowledgment, including those pertaining to warranty, patent infringement, and limitation of liability.

TI warrants performance of its semiconductor products to the specifications applicable at the time of sale in accordance with TI's standard warranty. Testing and other quality control techniques are utilized to the extent TI deems necessary to support this warranty. Specific testing of all parameters of each device is not necessarily performed, except those mandated by government requirements.

Customers are responsible for their applications using TI components.

In order to minimize risks associated with the customer's applications, adequate design and operating safeguards must be provided by the customer to minimize inherent or procedural hazards.

TI assumes no liability for applications assistance or customer product design. TI does not warrant or represent that any license, either express or implied, is granted under any patent right, copyright, mask work right, or other intellectual property right of TI covering or relating to any combination, machine, or process in which such semiconductor products or services might be or are used. TI's publication of information regarding any third party's products or services does not constitute TI's approval, warranty or endorsement thereof.