

MC14504B

Hex Level Shifter for TTL to CMOS or CMOS to CMOS

The MC14504B is a hex non-inverting level shifter using CMOS technology. The level shifter will shift a TTL signal to CMOS logic levels for any CMOS supply voltage between 5 and 15 volts. A control input also allows interface from CMOS to CMOS at one logic level to another logic level: Either up or down level translating is accomplished by selection of power supply levels V_{DD} and V_{CC} . The V_{CC} level sets the input signal levels while V_{DD} selects the output voltage levels.

- UP Translates from a Low to a High Voltage or DOWN Translates from a High to a Low Voltage
- Input Threshold Can Be Shifted for TTL Compatibility
- No Sequencing Required on Power Supplies or Inputs for Power Up or Power Down
- 3 to 18 Vdc Operation for V_{DD} and V_{CC}
- Diode Protected Inputs to V_{SS}
- Capable of Driving Two Low-Power TTL Loads or One Low-Power Schottky TTL Load Over the Rated Temperature Range

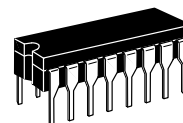

L SUFFIX
CERAMIC
CASE 620

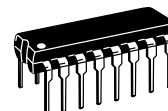

P SUFFIX
PLASTIC
CASE 648

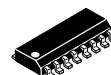

D SUFFIX
SOIC
CASE 751B

ORDERING INFORMATION

MC14XXXBCP Plastic
MC14XXXBCL Ceramic
MC14XXXBD SOIC

$T_A = -55^\circ$ to 125°C for all packages.

LOGIC DIAGRAM

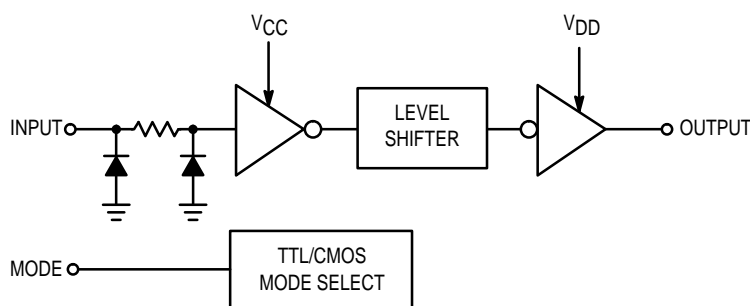

Mode Select	Input Logic Levels	Output Logic Levels
1 (V_{CC})	TTL	CMOS
0 (V_{SS})	CMOS	CMOS

1/6 of package shown.

PIN ASSIGNMENT

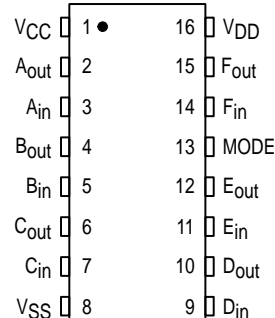

This device contains circuitry to protect the inputs against damage due to high static voltages or electric fields referenced to the V_{SS} pin, only. Extra precautions must be taken to avoid applications of any voltage higher than maximum rated voltages to this high-impedance circuit. For proper operation, the ranges $V_{SS} \leq V_{in} \leq 18\text{ V}$ and $V_{SS} \leq V_{out} \leq V_{DD}$ are recommended.

Unused inputs must always be tied to an appropriate logic voltage level (e.g., either V_{SS} or V_{DD}). Unused outputs must be left open.

MAXIMUM RATINGS* (Voltages Referenced to V_{SS})

Symbol	Parameter	Value	Unit
V _{CC}	DC Supply Voltage	– 0.5 to 18.0	V
V _{DD}	DC Supply Voltage	– 0.5 to + 18.0	V
V _{in}	Input Voltage (DC or Transient)	– 0.5 to + 18.0	V
V _{out}	Output Voltage (DC or Transient)	– 0.5 to V _{DD} + 0.5	V
I _{in} , I _{out}	Input or output Current (DC or Transient), per Pin	± 10	mA
P _D	Power Dissipation, per Package*	500	mW
T _{stg}	Storage Temperature	– 65 to + 150	°C
T _L	Lead Temperature (8–Second Soldering)	260	°C

* Maximum Ratings are those values beyond which damage to the device may occur.

† Temperature Derating:

Plastic “P and D/DW” Packages: – 7.0 mW/°C From 65°C To 125°C

Ceramic “L” Packages: – 12 mW/°C From 100°C To 125°C

ELECTRICAL CHARACTERISTICS (Voltages Referenced to V_{SS})

Characteristic	Symbol	V _{CC} Vdc	V _{DD} Vdc	– 55°C		25°C			125°C		Unit	
				Min	Max	Min	Typ #	Max	Min	Max		
Output Voltage V _{in} = 0 V	V _{OL}	—	5.0	—	0.05	—	0	0.05	—	0.05	Vdc	
		—	10	—	0.05	—	0	0.05	—	0.05		
		—	15	—	0.05	—	0	0.05	—	0.05		
V _{in} = V _{CC}	V _{OH}	—	5.0	4.95	—	4.95	5.0	—	4.95	—	Vdc	
		—	10	9.95	—	9.95	10	—	9.95	—		
		—	15	14.95	—	14.95	15	—	14.95	—		
Input Voltage (V _{OL} = 1.0 Vdc) TTL–CMOS (V _{OL} = 1.5 Vdc) TTL–CMOS (V _{OL} = 1.0 Vdc) CMOS–CMOS (V _{OL} = 1.5 Vdc) CMOS–CMOS (V _{OL} = 1.5 Vdc) CMOS–CMOS	V _{IL}	5.0	10	—	0.8	—	1.3	0.8	—	0.8	Vdc	
		5.0	15	—	0.8	—	1.3	0.8	—	0.8		
		5.0	10	—	1.5	—	2.25	1.5	—	1.4		
		5.0	15	—	1.5	—	2.25	1.5	—	1.5		
		10	15	—	3.0	—	4.5	3.0	—	2.9		
		—	—	—	—	—	—	—	—	—		—
Input Voltage (V _{OH} = 9.0 Vdc) TTL–CMOS (V _{OH} = 13.5 Vdc) TTL–CMOS (V _{OH} = 9.0 Vdc) CMOS–CMOS (V _{OH} = 13.5 Vdc) CMOS–CMOS (V _{OH} = 13.5 Vdc) CMOS–CMOS	V _{IH}	5.0	10	2.0	—	2.0	1.5	—	2.0	—	Vdc	
		5.0	15	2.0	—	2.0	1.5	—	2.0	—		
		5.0	10	3.6	—	3.5	2.75	—	3.5	—		
		5.0	15	3.6	—	3.5	2.75	—	3.5	—		
		10	15	7.1	—	7.0	5.5	—	7.0	—		
		—	—	—	—	—	—	—	—	—		—
Output Drive Current (V _{OH} = 2.5 Vdc) Source (V _{OH} = 4.6 Vdc) (V _{OH} = 9.5 Vdc) (V _{OH} = 13.5 Vdc)	I _{OH}	—	5.0	– 3.0	—	– 2.4	– 4.2	—	– 1.7	—	mA _{dc}	
		—	5.0	– 0.64	—	– 0.51	– 0.88	—	– 0.36	—		
		—	10	– 1.6	—	– 1.3	– 2.25	—	– 0.9	—		
	Sink (V _{OL} = 0.4 Vdc) (V _{OL} = 0.5 Vdc) (V _{OL} = 1.5 Vdc)	I _{OL}	—	5.0	0.64	—	0.51	0.88	—	0.36	—	mA _{dc}
			—	10	1.6	—	1.3	2.25	—	0.9	—	
			—	15	4.2	—	3.4	8.8	—	2.4	—	
Input Current	I _{in}	—	15	—	± 0.1	—	± 0.00001	± 0.1	—	± 1.0	μA _{dc}	
Input Capacitance (V _{in} = 0)	C _{in}	—	—	—	—	—	5.0	7.5	—	—	pF	
Quiescent Current (Per Package) CMOS–CMOS Mode	I _{DD} or I _{CC}	—	5.0	—	0.05	—	0.0005	0.05	—	1.5	μA _{dc}	
		—	10	—	0.10	—	0.0010	0.10	—	3.0		
		—	15	—	0.20	—	0.0015	0.20	—	6.0		
Quiescent Current (Per Package) TTL–CMOS Mode	I _{DD}	5.0	5.0	—	0.5	—	0.0005	0.5	—	3.8	μA _{dc}	
		5.0	10	—	1.0	—	0.0010	1.0	—	7.5		
		5.0	15	—	2.0	—	0.0015	2.0	—	15		
Quiescent Current (Per Package) TTL–CMOS Mode	I _{CC}	5.0	5.0	—	5.0	—	2.5	5.0	—	6.0	mA _{dc}	
		5.0	10	—	5.0	—	2.5	5.0	—	6.0		
		5.0	15	—	5.0	—	2.5	5.0	—	6.0		

#Data labelled “Typ” is not to be used for design purposes but is intended as an indication of the IC’s potential performance.

SWITCHING CHARACTERISTICS ($C_L = 50 \text{ pF}$, $T_A = 25^\circ\text{C}$)

Characteristic	Symbol	Shifting Mode	V _{CC} Vdc	V _{DD} Vdc	Limits			Unit
					Min	Typ #	Max	
Propagation Delay, High to Low	t _{PHL}	TTL – CMOS V _{DD} > V _{CC}	5.0	10	—	140	280	ns
			5.0	15	—	140	280	
		CMOS – CMOS V _{DD} > V _{CC}	5.0	10	—	120	240	
			5.0	15	—	120	240	
			10	15	—	70	140	
		CMOS – CMOS V _{CC} > V _{DD}	10	5.0	—	185	370	
15	5.0		—	185	370			
15	10		—	175	350			
Propagation Delay, Low to High	t _{PLH}	TTL – CMOS V _{DD} > V _{CC}	5.0	10	—	170	340	ns
			5.0	15	—	160	320	
		CMOS – CMOS V _{DD} > V _{CC}	5.0	10	—	170	340	
			5.0	15	—	170	340	
			10	15	—	100	200	
		CMOS – CMOS V _{CC} > V _{DD}	10	5.0	—	275	550	
15	5.0		—	275	550			
15	10		—	145	290			
Output Rise and Fall Time	t _{TLH} , t _{THL}	ALL	—	5.0	—	100	200	ns
			—	10	—	50	100	
			—	15	—	40	80	

#Data labelled "Typ" is not to be used for design purposes but is intended as an indication of the IC's potential performance.

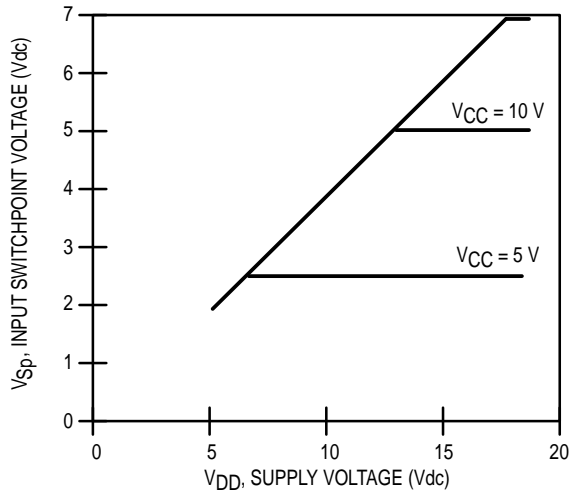

Figure 1. Input Switchpoint CMOS to CMOS Mode

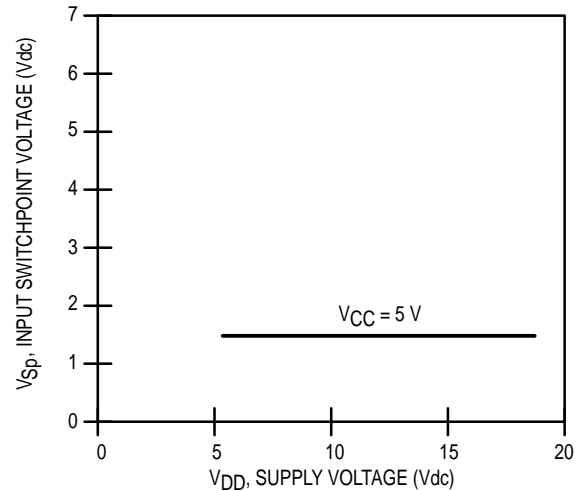

Figure 2. Input Switchpoint TTL to CMOS Mode

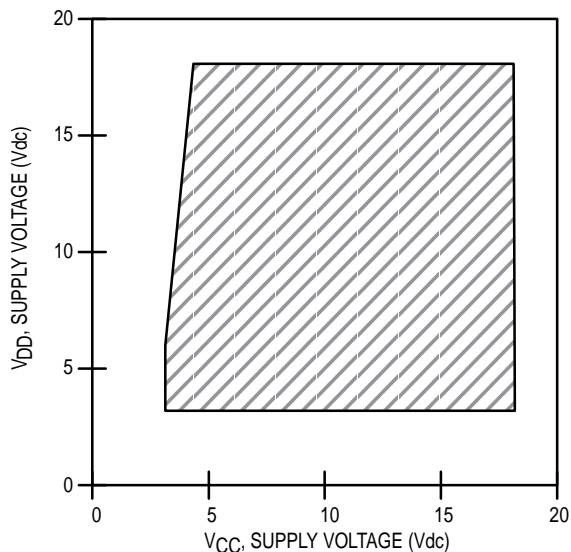

Figure 3. Operating Boundary CMOS to CMOS Mode

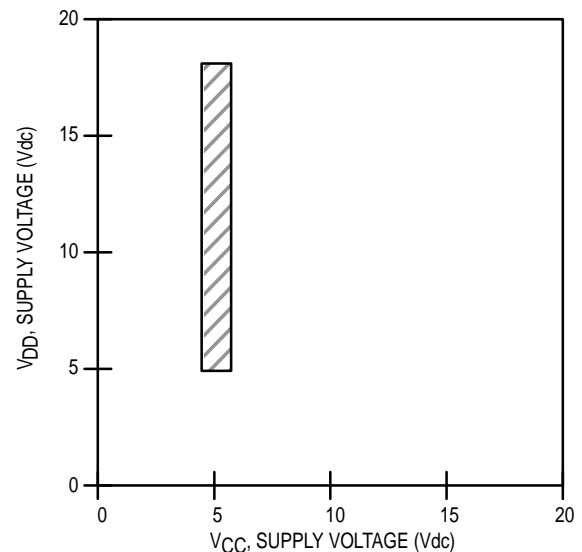
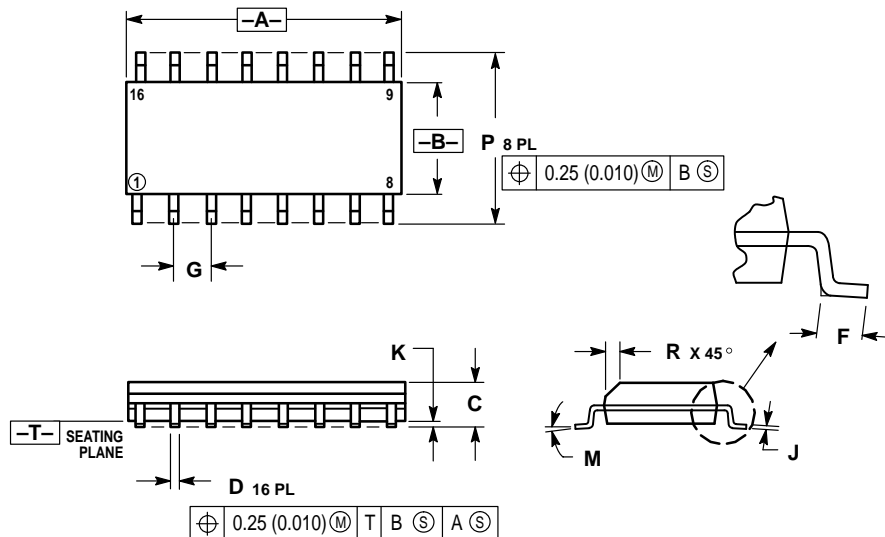

Figure 4. Operating Boundary TTL to CMOS Mode

OUTLINE DIMENSIONS

D SUFFIX PLASTIC SOIC PACKAGE CASE 751B-05 ISSUE J



NOTES:

1. DIMENSIONING AND TOLERANCING PER ANSI Y14.5M, 1982.
2. CONTROLLING DIMENSION: MILLIMETER.
3. DIMENSIONS A AND B DO NOT INCLUDE MOLD PROTRUSION.
4. MAXIMUM MOLD PROTRUSION 0.15 (0.006) PER SIDE.
5. DIMENSION D DOES NOT INCLUDE DAMBAR PROTRUSION. ALLOWABLE DAMBAR PROTRUSION SHALL BE 0.127 (0.005) TOTAL IN EXCESS OF THE D DIMENSION AT MAXIMUM MATERIAL CONDITION.

DIM	MILLIMETERS		INCHES	
	MIN	MAX	MIN	MAX
A	9.80	10.00	0.386	0.393
B	3.80	4.00	0.150	0.157
C	1.35	1.75	0.054	0.068
D	0.35	0.49	0.014	0.019
F	0.40	1.25	0.016	0.049
G	1.27 BSC		0.050 BSC	
J	0.19	0.25	0.008	0.009
K	0.10	0.25	0.004	0.009
M	0°	7°	0°	7°
P	5.80	6.20	0.229	0.244
R	0.25	0.50	0.010	0.019

Motorola reserves the right to make changes without further notice to any products herein. Motorola makes no warranty, representation or guarantee regarding the suitability of its products for any particular purpose, nor does Motorola assume any liability arising out of the application or use of any product or circuit, and specifically disclaims any and all liability, including without limitation consequential or incidental damages. "Typical" parameters which may be provided in Motorola data sheets and/or specifications can and do vary in different applications and actual performance may vary over time. All operating parameters, including "Typicals" must be validated for each customer application by customer's technical experts. Motorola does not convey any license under its patent rights nor the rights of others. Motorola products are not designed, intended, or authorized for use as components in systems intended for surgical implant into the body, or other applications intended to support or sustain life, or for any other application in which the failure of the Motorola product could create a situation where personal injury or death may occur. Should Buyer purchase or use Motorola products for any such unintended or unauthorized application, Buyer shall indemnify and hold Motorola and its officers, employees, subsidiaries, affiliates, and distributors harmless against all claims, costs, damages, and expenses, and reasonable attorney fees arising out of, directly or indirectly, any claim of personal injury or death associated with such unintended or unauthorized use, even if such claim alleges that Motorola was negligent regarding the design or manufacture of the part. Motorola and are registered trademarks of Motorola, Inc. Motorola, Inc. is an Equal Opportunity/Affirmative Action Employer.

How to reach us:

USA/EUROPE/Locations Not Listed: Motorola Literature Distribution;
P.O. Box 20912; Phoenix, Arizona 85036. 1-800-441-2447 or 602-303-5454

JAPAN: Nippon Motorola Ltd.; Tatsumi-SPD-JLDC, 6F Seibu-Butsuryu-Center,
3-14-2 Tatsumi Koto-Ku, Tokyo 135, Japan. 03-81-3521-8315

MFAX: RMFAX0@email.sps.mot.com – TOUCHTONE 602-244-6609
INTERNET: http://Design-NET.com

ASIA/PACIFIC: Motorola Semiconductors H.K. Ltd.; 8B Tai Ping Industrial Park,
51 Ting Kok Road, Tai Po, N.T., Hong Kong. 852-26629298



MC14504B/D

