

μA777 ✓

PRECISION OPERATIONAL AMPLIFIER FAIRCHILD LINEAR INTEGRATED CIRCUITS

GENERAL DESCRIPTION — The μA777C is a monolithic Precision Operational Amplifier constructed using a low-noise Fairchild Planar* epitaxial process. It is an excellent choice when performance versus cost trade-offs are possible between super beta or FET input operational amplifiers and low-cost general purpose operational amplifiers. Low offset and bias currents improve system accuracy when used in applications such as long-term integrators, sample and hold circuits and high-source impedance summing amplifiers. Even though the input bias current is extremely low, the μA777C maintains full ±30 V differential voltage range. The internal construction utilizes isothermal layout and special electrical design to maintain system performance despite variations in temperature or output load. High common mode input voltage range, latch-up protection, short-circuit protection and simple frequency compensation make the device versatile and easily used.

- **LOW OFFSET VOLTAGE AND OFFSET CURRENT**
- **LOW OFFSET VOLTAGE AND CURRENT DRIFT**
- **LOW INPUT BIAS CURRENT**
- **LOW INPUT NOISE VOLTAGE**
- **LARGE COMMON MODE AND DIFFERENTIAL VOLTAGE RANGES**

ABSOLUTE MAXIMUM RATINGS

Supply Voltage	±22 V
Internal Power Dissipation	
Metal Can	500 mW
DIP	670 mW
Mini DIP	310 mW
Differential Input Voltage	±30 V
Input Voltage (Note 1)	±15 V
Storage Temperature Range	
Metal Can and Hermetic DIP	-65° C to +150° C
Mini DIP	-55° C to +125° C
Operating Temperature Range	0° C to 70° C
Pin Temperature	
Metal Can and Hermetic DIP (Soldering, 60 s)	300° C
Mini DIP (Soldering, 10 s)	260° C
Output Short Circuit Duration (Note 2)	Indefinite

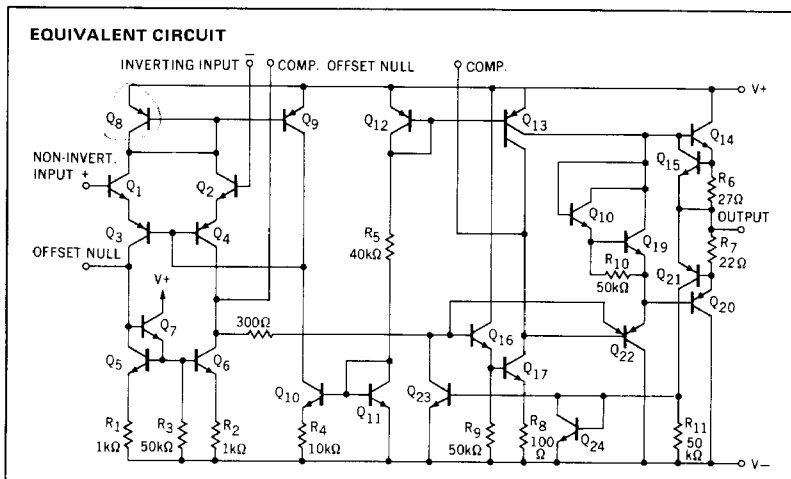

Notes on following pages.

CONNECTION DIAGRAMS

8-PIN METAL CAN (TOP VIEW)

PACKAGE OUTLINE 5S
PACKAGE CODE H

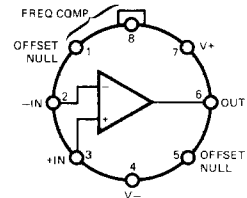

NOTE: Pin 4 connected to case

ORDER INFORMATION

TYPE	PART NO.
μA777C	μA777HC

14-PIN DIP (TOP VIEW)

PACKAGE OUTLINE 6A 9A
PACKAGE CODE D P

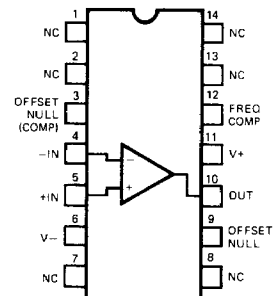

ORDER INFORMATION

TYPE	PART NO.
μA777C	μA777DC
μA777C	μA777PC

8-PIN MINI DIP (TOP VIEW)

PACKAGE OUTLINE 9T
PACKAGE CODE T

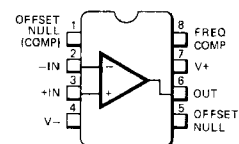

ORDER INFORMATION

TYPE	PART NO.
μA777C	μA777TC

*Planar is a patented Fairchild process.

FAIRCHILD • μ A777

μ A777

ELECTRICAL CHARACTERISTICS: $V_S = \pm 15$ V, $T_A = 25^\circ\text{C}$, $C_C = 30$ pF unless otherwise specified.

CHARACTERISTICS	CONDITIONS	MIN	TYP	MAX	UNITS
Input Offset Voltage	$R_S \leq 50$ k Ω		0.7	5.0	mV
Input Offset Current			0.7	20.0	nA
Input Bias Current			25	100	nA
Input Resistance		1.0	2.0		M Ω
Input Capacitance			3.0		pF
Offset Voltage Adjustment Range			± 25		mV
Large Signal Voltage Gain	$R_L \geq 2$ k Ω , $V_{OUT} = \pm 10$ V	25,000	250,000		V/V
Output Resistance			100		Ω
Output Short Circuit Current			± 25		mA
Supply Current			1.9	2.8	mA
Power Consumption			60	85	mW
Transient Response (Voltage Follower, Gain of 1)	$V_{IN} = 20$ mV, $C_C = 30$ pF, $R_L = 2$ k Ω , $C_L \leq 100$ pF	Rise Time	0.3		μ s
		Overshoot	5.0		%
Slew Rate (Voltage Follower, Gain of 1)	$R_L \geq 2$ k Ω		0.5		V/ μ s
Transient Response (Voltage Follower, Gain of 10)	$V_{IN} = 20$ mV, $C_C = 3.5$ pF, $R_L = 2$ k Ω , $C_L \leq 100$ pF	Rise Time	0.2		μ s
		Overshoot	5.0		%
Slew Rate (Voltage Follower, Gain of 10)	$R_L \leq 2$ k Ω , $C_C = 3.5$ pF		5.5		V/ μ s
The following specifications apply for $0^\circ\text{C} \leq T_A \leq +70^\circ\text{C}$					
Input Offset Voltage	$R_S \leq 50$ k Ω		0.8	5.0	mV
Average Input Offset Voltage Drift	$R_S \leq 50$ k Ω		4.0	30	μ V/ $^\circ\text{C}$
Input Offset Current				40	nA
Average Input Offset Current Drift	$25^\circ\text{C} \leq T_A \leq +70^\circ\text{C}$		0.01	0.3	nA/ $^\circ\text{C}$
	$0^\circ\text{C} \leq T_A \leq +25^\circ\text{C}$		0.02	0.6	nA/ $^\circ\text{C}$
Input Bias Current				200	nA
Input Voltage Range		± 12	± 13		V
Common Mode Rejection Ratio	$R_S \leq 50$ k Ω	70	95		dB
Supply Voltage Rejection Ratio	$R_S \leq 50$ k Ω		15	150	μ V/V
Large Signal Voltage Gain	$R_L \geq 2$ k Ω , $V_{OUT} = \pm 10$ V	15,000			V/V
Output Voltage Swing	$R_L \geq 10$ k Ω	± 12	± 14		V
	$R_L \geq 2$ k Ω	± 10	± 13		V
Power Consumption			60	100	mW

NOTES:

1. Rating applies to ambient temperatures up to 70°C . Above 70°C ambient derate linearly at 6.3 mW/ $^\circ\text{C}$ Metal Can, 8.3 mW/ $^\circ\text{C}$ for the DIP, and 5.6 mW/ $^\circ\text{C}$ for the Mini DIP.
2. For supply voltages less than ± 15 V, the absolute maximum input voltage is equal to the supply voltage.
3. Short circuit may be to ground or either supply. Rating applies to $+125^\circ\text{C}$ Case Temperature or $+75^\circ\text{C}$ Ambient Temperature.

TYPICAL PERFORMANCE CURVES

OPEN LOOP VOLTAGE GAIN AS A FUNCTION OF SUPPLY VOLTAGE

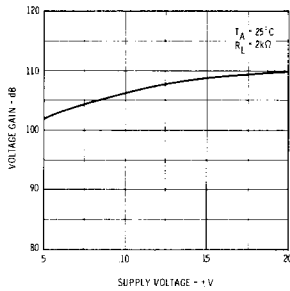

OUTPUT VOLTAGE SWING AS A FUNCTION OF SUPPLY VOLTAGE

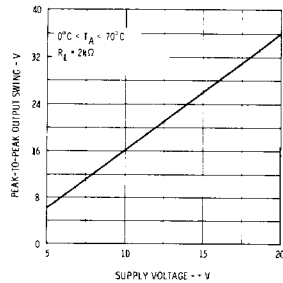

INPUT COMMON MODE VOLTAGE RANGE AS A FUNCTION OF SUPPLY VOLTAGE

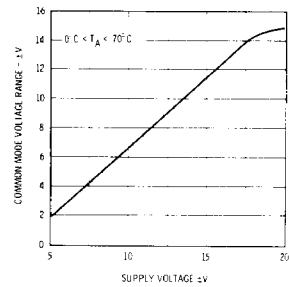

POWER CONSUMPTION AS A FUNCTION OF SUPPLY VOLTAGE

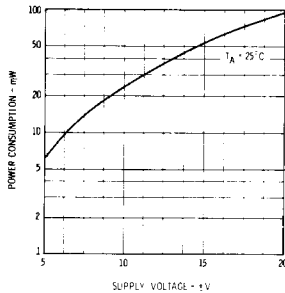

INPUT CURRENT AS A FUNCTION OF AMBIENT TEMPERATURE

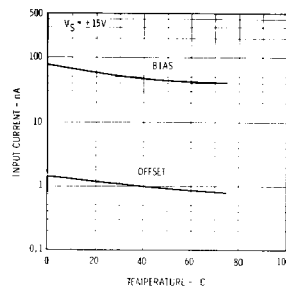

INPUT RESISTANCE AS A FUNCTION OF AMBIENT TEMPERATURE

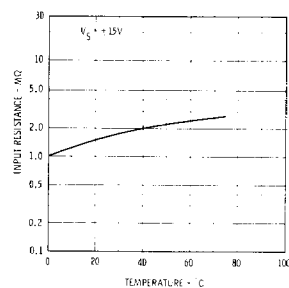

INPUT OFFSET CURRENT AS A FUNCTION OF SUPPLY VOLTAGE

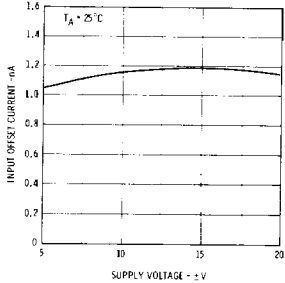

POWER CONSUMPTION AS A FUNCTION OF AMBIENT TEMPERATURE

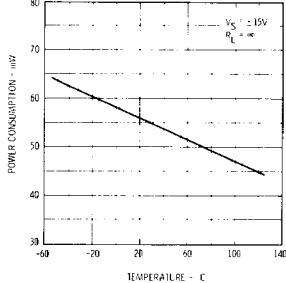

OUTPUT VOLTAGE SWING AS A FUNCTION OF LOAD RESISTANCE

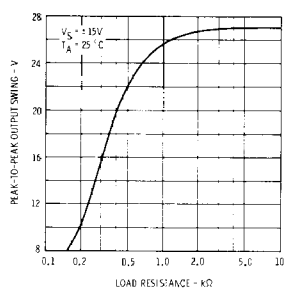

OUTPUT SHORT-CIRCUIT CURRENT AS A FUNCTION OF AMBIENT TEMPERATURE

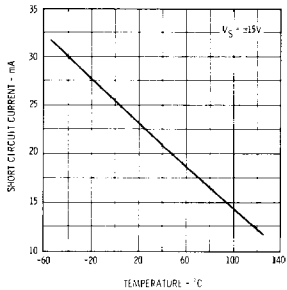

INPUT NOISE VOLTAGE AND CURRENT AS A FUNCTION OF FREQUENCY

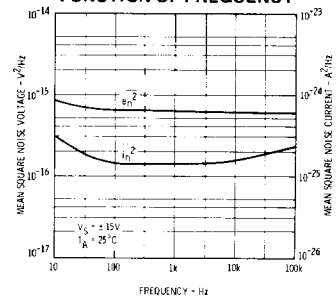

TYPICAL PERFORMANCE CURVES

OPEN LOOP VOLTAGE GAIN AS A FUNCTION OF FREQUENCY

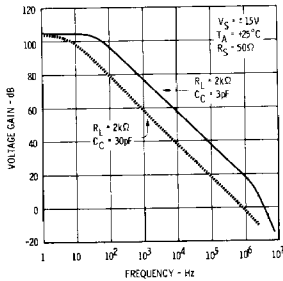

OPEN LOOP PHASE RESPONSE AS A FUNCTION OF FREQUENCY

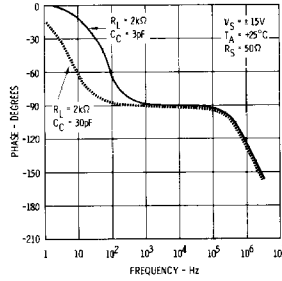

OUTPUT VOLTAGE SWING AS A FUNCTION OF FREQUENCY

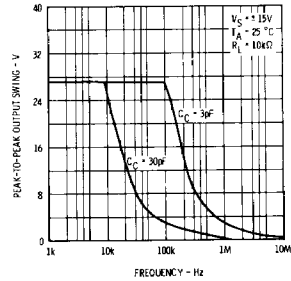

OPEN LOOP VOLTAGE GAIN AS A FUNCTION OF FREQUENCY FOR VARIOUS GAIN/COMPENSATION OPTIONS

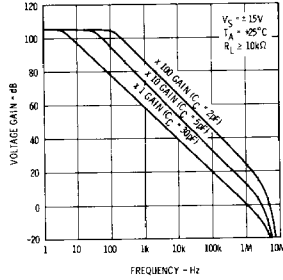

FREQUENCY RESPONSE FOR VARIOUS CLOSED-LOOP GAINS

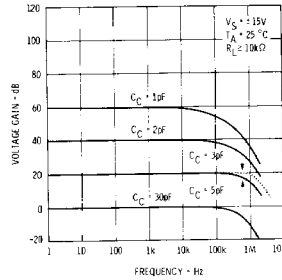

COMPENSATION CAPACITANCE AS A FUNCTION OF CLOSED LOOP VOLTAGE GAIN

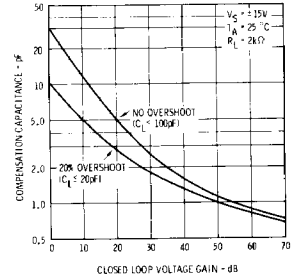

INPUT RESISTANCE, OUTPUT RESISTANCE, AND INPUT CAPACITANCE AS A FUNCTION OF FREQUENCY

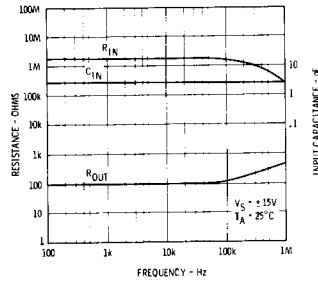

COMMON MODE REJECTION RATIO AS A FUNCTION OF FREQUENCY

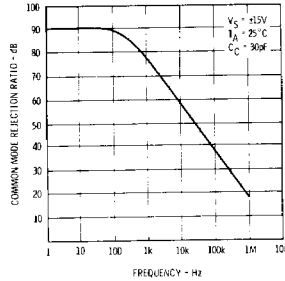

INPUT OFFSET VOLTAGE DRIFT AS A FUNCTION OF TIME

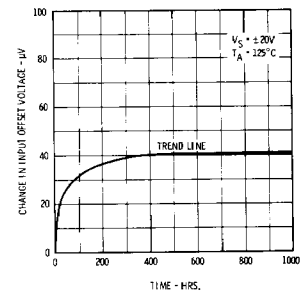

VOLTAGE FOLLOWER TRANSIENT RESPONSE (GAIN OF 1)

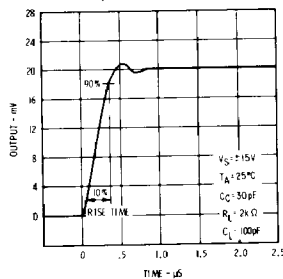

TRANSIENT RESPONSE TEST CIRCUIT

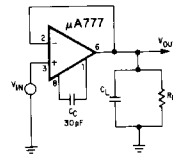

VOLTAGE FOLLOWER LARGE SIGNAL PULSE RESPONSE

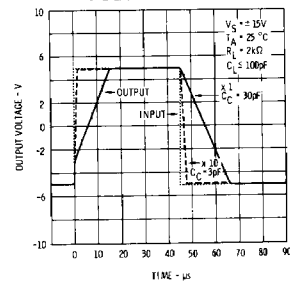

TYPICAL PERFORMANCE CURVES

THERMAL RESPONSE OF INPUT OFFSET VOLTAGE TO STEP CHANGE OF CASE TEMPERATURE

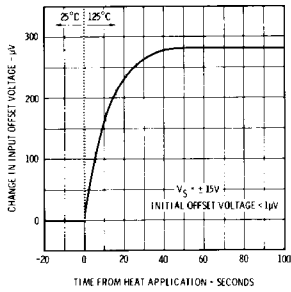

STABILIZATION TIME OF INPUT OFFSET VOLTAGE FROM POWER TURN-ON

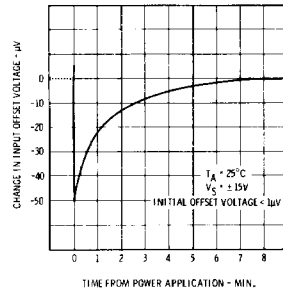

FEED FORWARD COMPENSATION

LARGE SIGNAL FEEDFORWARD TRANSIENT RESPONSE

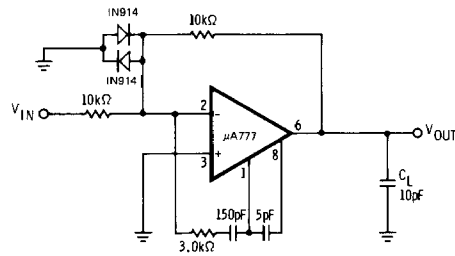
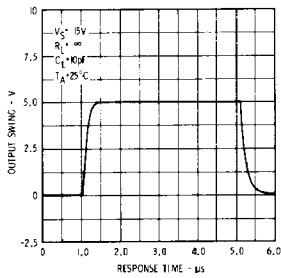

5

VOLTAGE OFFSET NULL CIRCUIT

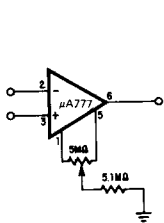

SUGGESTED

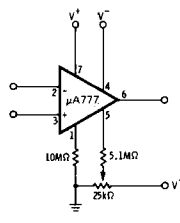

ALTERNATE

GAIN TEST CIRCUIT

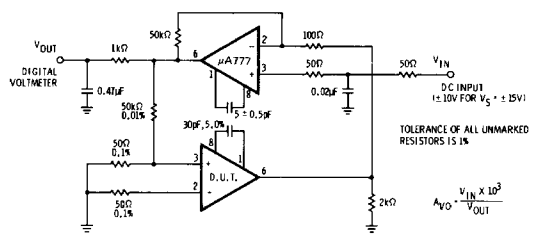

TYPICAL APPLICATIONS

BIAS COMPENSATED LONG TIME INTEGRATOR

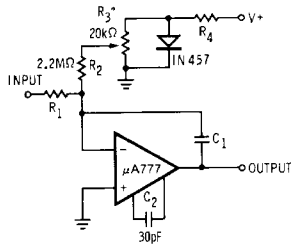

* Adjust R_3 for minimum integrator drift

SAMPLE AND HOLD

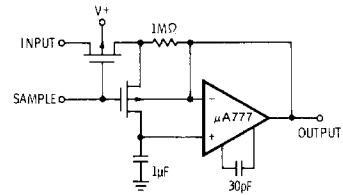

CAPACITANCE MULTIPLIER

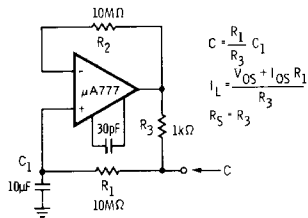

AMPLIFIER FOR CAPACITANCE TRANSDUCERS

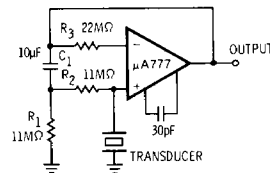

Low Frequency Cutoff $R_1 \times C_1$

BILATERAL CURRENT SOURCE

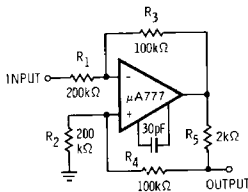

$$I_{OUT} = \frac{R_3}{R_1} \frac{V_{IN}}{R_5}; R_1 = R_2; R_3 = R_4 + R_5$$

HIGH SLEW RATE POWER AMPLIFIER

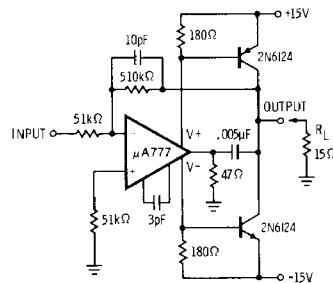

± 100 V COMMON MODE RANGE INSTRUMENTATION AMPLIFIER

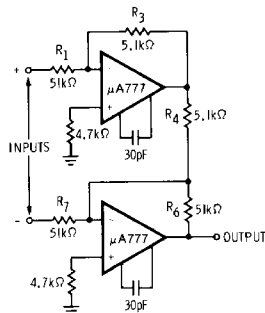

$$\frac{R_1}{R_7} \cong \frac{R_3}{R_4} \text{ for best CMRR}$$

$$R_3 = R_4$$

$$R_1 = R_6 = 10R_3$$

$$\text{Gain} = \frac{R_7}{R_6}$$

INSTRUMENTATION AMPLIFIER WITH HIGH COMMON MODE REJECTION

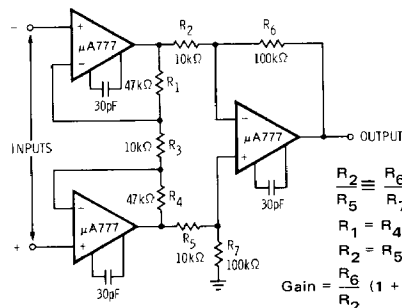

$$\frac{R_2}{R_5} \cong \frac{R_6}{R_7} \text{ for best CMRR}$$

$$R_1 = R_4$$

$$R_2 = R_5$$

$$\text{Gain} = \frac{R_6}{R_2} \left(1 + \frac{2R_1}{R_3} \right)$$