

RoHS compliant

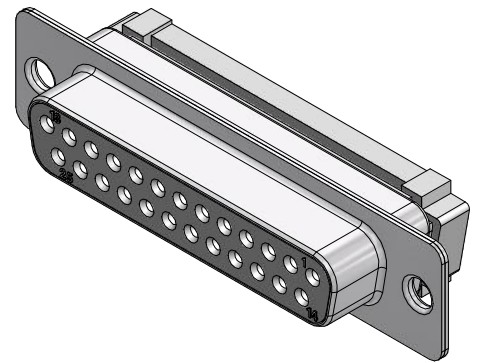
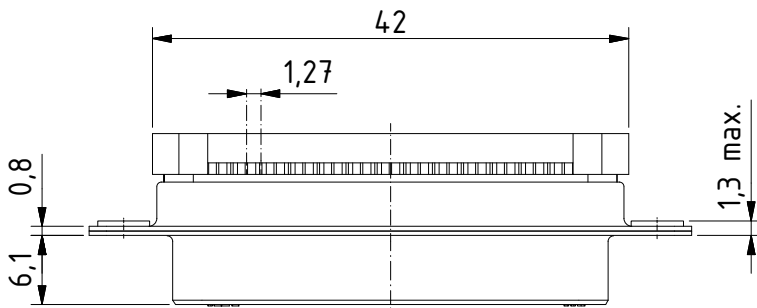
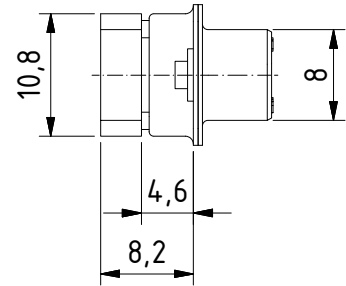
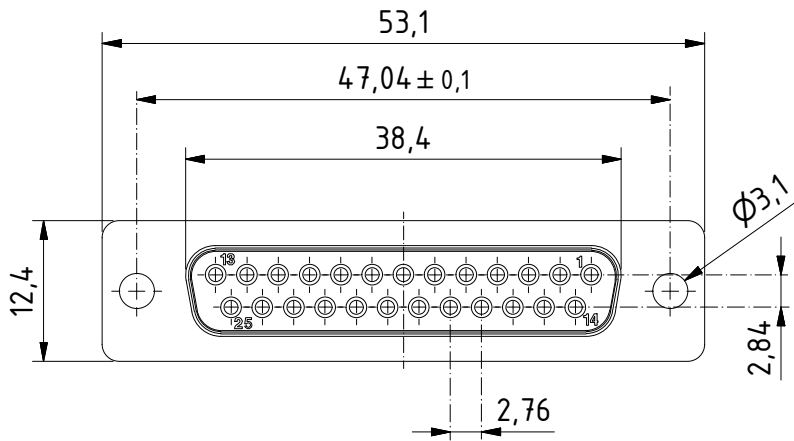

suitable for cable AWG 28-26

MATERIALS

- Insulator: Thermoplastic UL 94-V-0 grey
- Contact: Copper alloy
- Contact finish: Quality class 2
- Shell: steel tin plated

CHARAKTERISTICS

- Working voltage: 125V
- Current rating: 1A
- Contact resistance: max. 10mΩ - DIN41652
- Insulation resistance: >5GΩ
- Temperature range: -55° to +125°C

General tolerances (Deltron standard)			
size in mm			
> 0.5	> 3	> 6	> 30
up to 3	up to 6	up to 30	up to 120
tolerances			
±0.1	±0.2	±0.2	±0.3

modification	Rev.	Rev.	Rev.	DE004221 part no.		
	Rev.	Rev.	Rev.			
DTS25SFC/2	1.5:1 scale	drawn	26.10.2009	nf		
		checked				
		approved				
 Industrie Neuhof 8c CH-3422 Kirchberg				K055031 drawing no.		