

**Silicon NPN Power Transistors**

**2N6534**

**DESCRIPTION**

- With TO-66 package
- DARLINGTON

**APPLICATIONS**

- Power switching
- Hammer drivers
- Series and shunt regulators
- Audio amplifiers

**PINNING (See Fig.2)**

PIN	DESCRIPTION
1	Base
2	Emitter
3	Collector

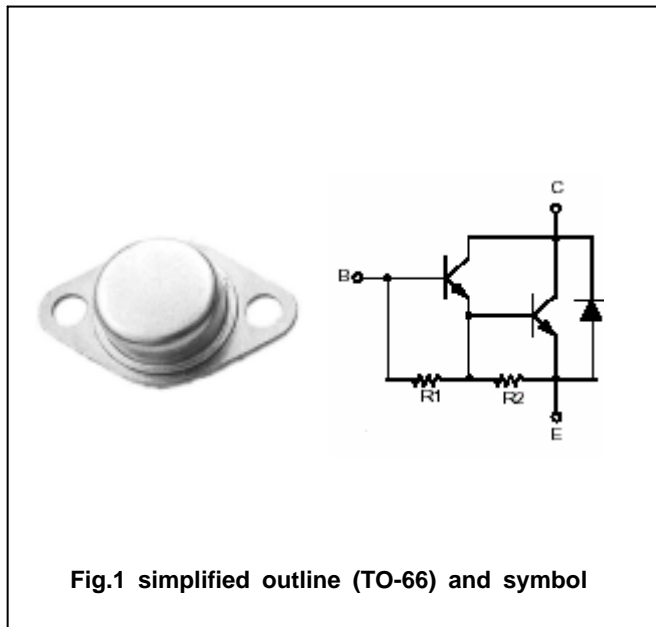

Fig.1 simplified outline (TO-66) and symbol

**Absolute maximum ratings(Ta=25 )**

SYMBOL	PARAMETER	CONDITIONS	VALUE	UNIT
V <sub>CBO</sub>	Collector-base voltage	Open emitter	80	V
V <sub>CEO</sub>	Collector-emitter voltage	Open base	80	V
V <sub>EBO</sub>	Emitter-base voltage	Open collector	5	V
I <sub>C</sub>	Collector current		8	A
I <sub>CM</sub>	Collector current-Peak		15	A
I <sub>B</sub>	Base current		0.25	A
P <sub>T</sub>	Total power dissipation	T <sub>C</sub> =25	36	W
T <sub>j</sub>	Junction temperature		150	
T <sub>stg</sub>	Storage temperature		-65~150	

## Silicon NPN Power Transistors

2N6534

## CHARACTERISTICS

T<sub>j</sub>=25 unless otherwise specified

SYMBOL	PARAMETER	CONDITIONS	MIN	TYP.	MAX	UNIT
V <sub>CEQ(SUS)</sub>	Collector-emitter sustaining voltage	I <sub>C</sub> =0.2A ; I <sub>B</sub> =0	80			V
V <sub>CEsat-1</sub>	Collector-emitter saturation voltage	I <sub>C</sub> =5A ; I <sub>B</sub> =10mA			2.0	V
V <sub>CEsat-2</sub>	Collector-emitter saturation voltage	I <sub>C</sub> =8A ; I <sub>B</sub> =80m A			3.0	V
V <sub>BE-1</sub>	Base -emitter on voltage	I <sub>C</sub> =5A ; V <sub>CE</sub> =3V			2.8	V
V <sub>BE-2</sub>	Base -emitter on voltage	I <sub>C</sub> =8A ; V <sub>CE</sub> =3V			4.5	V
I <sub>CEV</sub>	Collector cut-off current	V <sub>CE</sub> =80V; V <sub>BE</sub> =-1.5V T <sub>C</sub> =125			0.5 5.0	mA
I <sub>CEO</sub>	Collector cut-off current	V <sub>CE</sub> =80V; I <sub>B</sub> =0			1.0	mA
I <sub>EBO</sub>	Emitter cut-off current	V <sub>EB</sub> =5V; I <sub>C</sub> =0			5.0	mA
h <sub>FE-1</sub>	DC current gain	I <sub>C</sub> =5A ; V <sub>CE</sub> =3V	1000		10000	
h <sub>FE-2</sub>	DC current gain	I <sub>C</sub> =8A ; V <sub>CE</sub> =3V	100		5000	
V <sub>F</sub>	Diode forward voltage	I <sub>F</sub> =8A			5.0	V

Silicon NPN Power Transistors

2N6534

PACKAGE OUTLINE

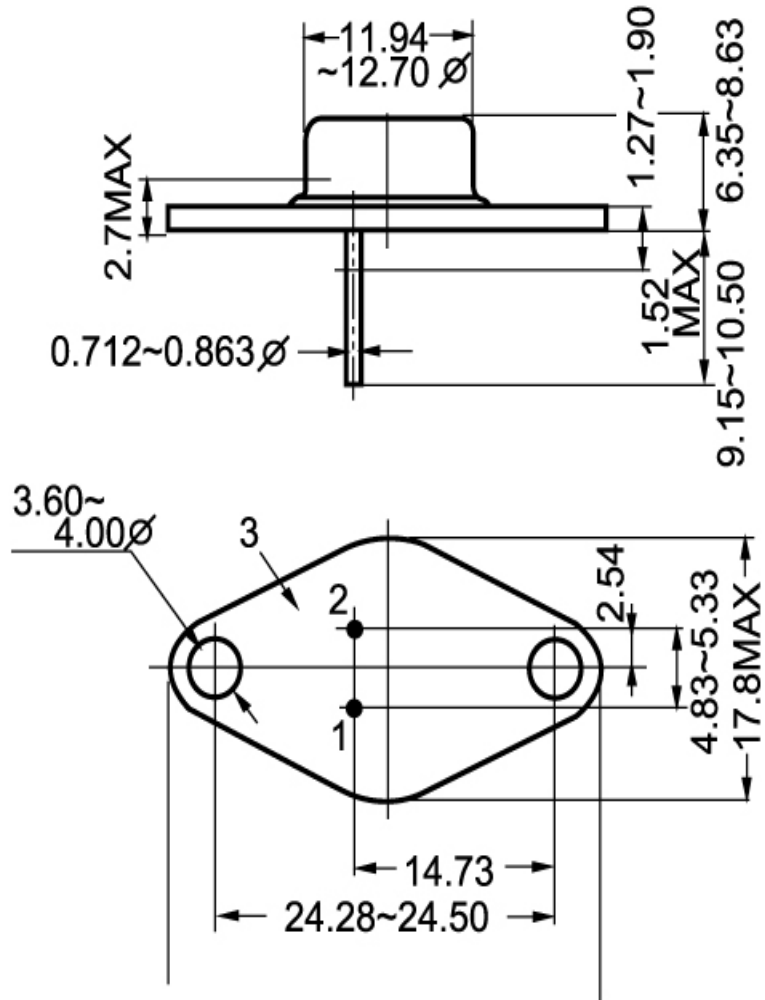

Fig.2 Outline dimensions